

BH-T SERIES

Analytical Balances

INSTRUCTION MANUAL



A&D Company, Ltd.

Warning Definition

The warnings described in this manual have the following meanings:

 CAUTION	A potentially hazardous situation which, if not avoided, may result in minor or moderate injury or damage to the instrument.
CAUTION	Cautions to use the device correctly.
Note	Information or cautions to use the device correctly.

About This Manual

- (1) No part of this manual may be reprinted, copied, modified, or translated to another language without the prior written consent of A&D Company, Limited (A&D).
- (2) The contents of this manual are subject to change without notice.
- (3) Please contact A&D if you notice any uncertainty, errors, omissions, etc. in this manual.
- (4) A&D bears no liability for any loss or lost profits due to the operation of this product, and for direct, indirect, special, or consequential damages resulting from any defect in this product or this manual, even if advised of the possibility of such damage. Furthermore, A&D assumes no liability for claims of rights from third parties. Concurrently, A&D assumes no liability whatsoever for software or data losses.

© 2025 A&D Company, Limited

- Microsoft®, Windows®, Word®, and Excel® are trademarks of the Microsoft group of companies.
- The Bluetooth® word mark and logos are registered trademarks owned by Bluetooth SIG, Inc. and any use of such marks by A&D is under license.
- iOS is the name of the operating system of Apple Inc. iOS is a trademark or registered trademark of Cisco in the U.S. and other countries and is used under license.
- Apple, the Apple logo and iPhone are trademarks of Apple Inc.
- App Store is a service mark of Apple Inc.
- Android™, Google Play and the Google Play logo are trademarks of Google LLC.
- Other product names and company names mentioned in this manual are trademarks or registered trademarks of their respective companies in Japan or other countries and regions.

Contents

1. Introduction	9
1.1. About the models	9
1.2. Features	10
1.3. Compliance	11
2. Part Names, Installation and Precautions.....	12
2.1. Unpacking	13
2.2. Assembly and installation.....	14
2.3. Installation considerations, preparation and precautions.....	17
2.4. How to adjust the level of the balance	18
2.5. Precautions during use for more accurate weighing.....	19
2.6. Precautions after weighing (maintenance of the balance).....	21
2.7. Caution on the power supply.....	21
3. Screen and Operation (Keys and Buttons).....	22
3.1. Standby screen	22
3.2. [HOME] screen (weighing screen)	22
3.3. On-screen operation buttons.....	25
3.4. Input screen.....	25
3.4.1. Numerical value input screen	25
3.4.2. [Character input] screen	26
3.4.3. [Password input] screen	27
4. IR Sensors and Auto Doors	28
4.1. IR sensors	28
4.2. Auto doors	28
5. Application.....	30
5.1. [Application] settings screen	30
5.1.1. Unit of measure	31
5.2. Normal weighing.....	34
5.2.1. Basic weighing.....	34
5.2.2. Zero-point, tare, and weighing range	36
5.2.3. Smart range function	37
5.3. Counting mode (PCS)	39
5.3.1. Storing a unit weight: [Counting mode setting] screen.....	40
5.3.2. Counting mode sample input: [Sample input mode] screen.....	41
5.3.3. ACAI function.....	43
5.3.4. Unit weight list.....	44
5.3.5. Editing and storing a unit weight: [Counting mode setting] screen	45
5.4. Percent mode: [Percent weighing] screen	46
5.4.1. Storing a 100% mass: [Percent mode setting] screen	46
5.4.2. Percent mode sample input: [Sample input mode] screen.....	47
5.5. Minimum weight alert function.....	49
5.5.1. Minimum weight setting	50
5.5.2. Minimum weight input: [Minimum weight setting] screen	51
5.5.3. Minimum weight setting for measurement.....	52

5.5.4.	Minimum weight measurement result.....	54
5.6.	Formulation function.....	55
5.6.1.	Selecting a recipe.....	56
5.6.2.	Searching a recipe.....	57
5.6.3.	Editing a recipe.....	58
5.6.4.	Editing a sample.....	59
5.6.5.	Registering a sample.....	60
5.6.6.	Sample weighing screen.....	61
5.6.7.	Tare weighing screen.....	62
5.6.8.	Measurement results screen.....	63
5.6.9.	Recipe registration example.....	64
5.6.10.	Measurement example.....	66
5.6.11.	Exporting/importing recipes.....	67
5.7.	HPLC function.....	68
5.7.1.	Selecting a recipe.....	69
5.7.2.	Searching a recipe.....	70
5.7.3.	Editing a recipe.....	71
5.7.4.	Editing a sample.....	72
5.7.5.	Registering a sample.....	74
5.7.6.	Sample weighing screen.....	75
5.7.7.	Tare weighing screen.....	76
5.7.8.	Measurement results screen.....	76
5.7.9.	Recipe registration example.....	78
5.7.10.	Measurement example.....	81
5.7.11.	Exporting/importing recipes.....	82
5.8.	Density (specific gravity) measurement function.....	83
5.8.1.	Measurement conditions.....	84
5.8.2.	Measuring the density (specific gravity) of a solid (liquid density input).....	85
5.8.3.	Measuring the density (specific gravity) of a solid (liquid temperature input).....	87
5.8.4.	Measuring the density (specific gravity) of a liquid.....	89
5.9.	Statistical calculation function.....	91
5.9.1.	Statistical calculation results.....	92
5.9.2.	Statistical calculation output example.....	94
5.10.	Capacity indicator.....	95
5.11.	Net/gross/tare function.....	96
5.12.	Warning display.....	97
5.12.1.	Impact shock detection (ISD) function.....	98
6.	Quick Performance Check: [Repeatability Measurement] Screen.....	99
7.	Communication Device.....	100
7.1.	[Communication device] – [USB flash drive] settings.....	100
7.2.	[Communication device] - [USB device] settings.....	101
7.3.	[Communication device] - [Bluetooth] settings.....	102
8.	Password Function.....	103
8.1.	[Log-in] screen.....	104
8.2.	User authorization.....	105
8.2.1.	User authorization - Change to settings not allowed.....	106

8.2.2.	User authorization - Date/time setting not allowed.....	109
8.2.3.	User authorization - Ext. sensitivity adjustment not allowed.....	110
8.2.4.	User authorization - Int. sensitivity adjustment not allowed.....	111
8.3.	User management.....	112
8.3.1.	User management for registration.....	113
8.3.2.	User management for edit.....	114
9.	[MENU] Screen.....	115
10.	[Sensitivity Adjustment] Screen.....	116
10.1.	Internal sensitivity adjustment.....	117
10.2.	External sensitivity adjustment.....	118
10.2.1.	Procedure for external sensitivity adjustment.....	119
10.3.	Automatic sensitivity adjustment.....	120
10.4.	Sensitivity adjustment setting.....	122
10.5.	Correcting the internal weight value.....	122
11.	Calibration Test/Check.....	123
11.1.	Daily check.....	124
11.1.1.	Output example for daily check output results.....	129
11.2.	Periodic check.....	131
11.2.1.	Output example for periodic check output results.....	141
11.3.	Repeatability check.....	143
11.3.1.	Repeatability measurement with the internal weight.....	144
11.3.2.	Repeatability measurement with the internal weight.....	145
11.4.	Internal calibration test.....	146
11.5.	External calibration test.....	147
11.6.	AND-MEET.....	148
11.6.1.	[AND-MEET weighing] screen.....	150
11.6.2.	[AND-MEET graph] screen.....	151
11.6.3.	Description of a graph: temperature/zero point change/span.....	152
11.6.4.	Description of a graph: temperature/repeatability.....	152
11.6.5.	[AND-MEET result list] screen.....	153
11.6.6.	[AND-MEET result] screen.....	154
11.6.7.	AND-MEET analysis graph example.....	155
11.7.	Daily/periodic check settings.....	156
11.8.	Daily/periodic check reminder.....	157
11.8.1.	Startup screen when the daily check reminder is set to ON.....	158
11.8.2.	Startup screen when the periodic check reminder is set to ON.....	158
11.9.	Standard value setting.....	159
11.9.1.	Standard value setting: Repeatability.....	159
11.9.2.	Standard value setting: Sensitivity test.....	160
11.9.3.	Standard value setting: Eccentricity.....	161
11.10.	Report data.....	162
12.	Filter Settings.....	163
12.1.	Commentary on filter settings.....	164

13. System Settings	165
13.1. Display settings	166
13.2. IR sensors	167
13.3. Breeze break auto doors	168
13.4. Date/time setting	169
13.5. Buzzer	170
13.6. Communication	171
13.7. Data output.....	171
13.8. Data output mode.....	172
13.9. Data to be added.....	173
13.10. Data output settings	174
13.11. Command settings	175
13.12. GLP output/Label output	176
13.13. GLP output	177
13.14. GLP custom output.....	183
13.14.1. Template	184
13.14.2. Editing templates	185
13.14.3. List of print data	186
13.14.4. Setting example of GLP custom output.....	187
13.14.5. Header	189
13.14.6. Editing headers.....	190
13.14.7. Footer	191
13.14.8. Editing footers.....	192
13.15. Label output.....	193
13.15.1. Template	194
13.15.2. Editing templates	195
13.15.3. Resizing	196
13.15.4. Setting example for label output.....	197
13.16. RS-232C interface.....	199
13.17. USB interface	200
13.18. Wired LAN port.....	201
13.19. Bluetooth	202
13.20. UFC format.....	203
13.21. Language	204
13.22. ID number settings	204
13.23. External input switch	205
13.24. Initialization.....	205
13.25. Balance status.....	206
13.26. Balance information.....	206
13.27. Software version.....	207
13.28. History	207
13.29. Log-in/log-out history.....	208
13.30. Operation history	209
13.31. Sensitivity adjustment history.....	210
13.32. Impact shock detection history.....	211

14. Underhook Weighing	212
15. Interface Specifications (Standard).....	213
15.1. RS-232C specifications	213
15.2. USB specifications	214
15.3. USB flash drive (USB host).....	215
15.4. External input terminal (external input switch)	216
15.5. Wired LAN specifications	217
15.5.1. Network settings	218
16. Connection with Peripheral Devices	219
16.1. Cables required to connect to peripheral devices	219
16.2. Data output method.....	220
16.3. Examples: Connecting multiple peripheral devices	221
16.3.1. Printer and PC connection.....	221
16.3.2. Printer and remote display connection	222
17. Printing Weighing Value Data with a Printer	224
17.1. Printer: AD-8127, AD-8129TH.....	224
17.1.1. Printing only weighing value data	224
17.1.2. Printing weighing data with ID and timestamp using the balance's clock/calendar function..	225
17.1.3. Printing information other than weighing value data	226
18. Connecting to a PC	227
18.1. Quick USB mode	227
18.2. Virtual COM mode	228
18.3. RS-232C.....	228
18.4. LAN.....	228
18.5. Bluetooth	228
18.6. Data communication software	229
18.6.1. WinCT (USB virtual COM mode or RS-232C).....	229
18.6.2. WinCT-Plus (wired LAN).....	229
19. Data Output.....	230
19.1. Data output mode.....	230
19.1.1. Key mode.....	230
19.1.2. Auto print mode	230
19.1.3. Stream mode	231
19.1.4. Interval mode	231
19.2. Weighing data format	232
19.2.1. Output examples of weighing data format.....	237
19.2.2. Other data formats.....	240
20. Command.....	242
20.1. Control commands	242
20.2. AK code and error codes	245
20.3. Command usage examples	246

21. UFC Function	248
21.1. UFC program commands	248
21.1.1. Examples of UFC program command creation	249
22. Key Lock Function	250
22.1. Locking all key switches	250
22.2. Sensitivity adjustment while the keys are locked	250
22.2.1. Procedure for external sensitivity adjustment while the keys are locked	251
23. Ionizer	252
23.1. Using the ionizer	252
23.2. Optimizing the ionizer	253
23.3. Maintaining the ionizer	254
24. Maintenance	255
24.1. Treatment of the balance	255
25. Troubleshooting	257
25.1. Checking the balance performance and environment	257
25.2. Error displays (error codes)	258
25.3. Asking for repair	260
26. Specifications	261
26.1. Common specifications	261
26.1.1. Function	261
26.1.2. Size/weight	261
26.2. Individual specifications	262
26.3. External dimensions	264
27. Peripherals	265
28. Compliance	268
28.1. Compliance with FCC rules	268
28.2. IC	268
28.3. Bluetooth®	268

1. Introduction

Thank you for purchasing A&D's electronic balance.

Please read this instruction manual carefully to understand and make full use of the BH-T series analytical electronic balance.

CAUTION

- Operations may differ depending on the software version of your balance.
For confirmation of the software version of the balance, refer to "[13.27. Software version](#)".

1.1. About the models

This series includes a variety of models with different combinations of weighing capacity and readability. In this manual, the models are classified by readability, as shown in the table below.

Classification	Readability	Model
0.01 mg model	0.01 mg	BH-225TE BH-225DTE
0.1 mg model	0.1 mg	BH-224TE BH-324TE

1.2. Features

- ❑ A 5-inch touch screen is adopted for easy operation.
- ❑ Intuitive operation is provided through the touch screen.
- ❑ Equipped with the breeze break auto doors that can be opened and closed without touching them.
- ❑ The removable glass breeze break facilitates easy cleaning of the weighing chamber.
- ❑ A self-check function is included for automatically evaluating repeatability performance without a weight.
- ❑ The BA-T series can automatically perform sensitivity adjustment with the internal weight. (Automatic sensitivity adjustment)
(Temperature change, set time, fixed time interval [interval time])
- ❑ When performing the sensitivity adjustment/calibration test, etc. for the balance, the output corresponding to GLP/GMP, etc. can be output.
Using a printer (sold separately), it is possible to record the sensitivity adjustment/calibration test results.
GLP: Good Laboratory Practice, standards for implementing safety tests for drugs and medicines.
GMP: Good Manufacturing Practice, rules for manufacturing and quality control.
- ❑ The clock built into the balance allows you to output the weighing value with the date and time.
The clock settings can be restricted so that only the Administrator can change them. (Password function)
- ❑ The balance comes standard with the underhook for weighing magnetic materials.
- ❑ Seven different applications are available.
Normal weighing, counting mode, percent weighing, minimum weight alert function, formulation mode, HPLC mode, and density measurement mode.
- ❑ BH-225DTE has the smart range function as standard. This function allows for weighing with the precision range after subtracting the tare within the weighing capacity.
The readability of precision range for BH-225DTE is 0.01 mg.
- ❑ With the password function, the sensitivity adjustment of the balance and the operation of changing the function table can be restricted.
- ❑ An RS-232C interface, USB interface, Ethernet and Bluetooth® for outputting the weighing value and data of the balance are equipped as standard.
- ❑ It is possible to communicate with a Windows PC that has data communication software WinCT or WinCT-Plus installed. The software can be downloaded from the A&D website (<https://www.aandd.jp>).
- ❑ The BH-T series is equipped with a DC-type ionizer (static eliminator) that produces no air currents and eliminates static electricity from charged objects before weighing, thereby reducing errors due to static electricity. The discharge electrode unit of the ionizer is removable, allowing for the cleaning and replacement of only the ionizer.

1.3. Compliance

Compliance with FCC rules

Please note that this equipment generates, uses and can radiate radio frequency energy. This equipment has been tested and has been found to comply with the limits of Class A digital devices pursuant to Part 15 of FCC rules. These rules are designed to provide reasonable protection against interference when equipment is operated in a commercial environment. If this unit is operated in a residential area, it may cause some interference and under these circumstances the user would be required to take, at his own expense, whatever measures are necessary to eliminate the interference.

(FCC = Federal Communications Commission in the U.S.A.)

2. Part Names, Installation and Precautions

CAUTION

- ❑ This product is a precision instrument, and it should be carefully unpacked.
The contents of the package vary depending on the product. Refer to the illustration of the packing contents and make sure that everything is included.
- ❑ It is advisable to store the packing materials so that they can be used when transporting the balance for repair.
- ❑ Do not connect the AC adapter to the balance until the balance is assembled and installed.
- ❑ Do not connect the included AC adapter to other devices.
- ❑ Use the dedicated AC adapter specified for the balance.
- ❑ If you use the wrong AC adapter, the balance and other equipment may not work properly.

2.1. Unpacking

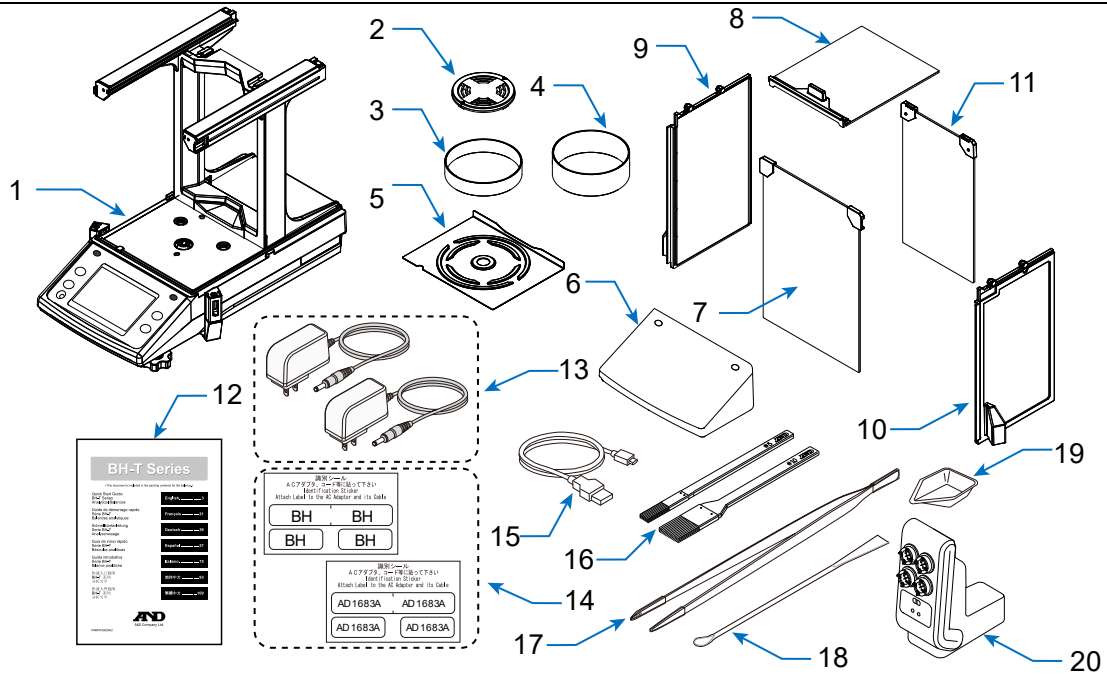

Front view

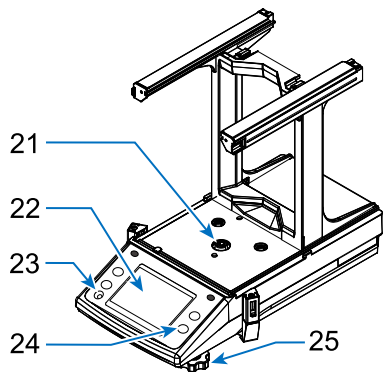

Rear view

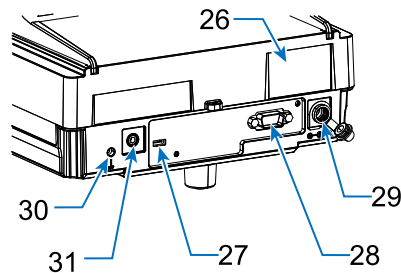

Side view

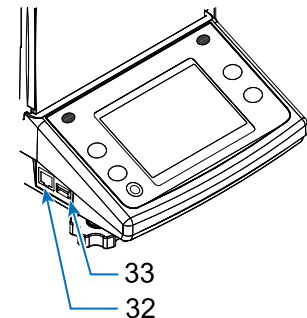

- | | | | |
|----|--|----|---|
| 1 | Main unit | 18 | Spatula (for 0.01 mg models* ¹ only) |
| 2 | Weighing pan | 19 | Weigh boat (10 pcs) |
| 3 | Low breeze break ring | 20 | AD-1683A ionizer |
| 4 | High breeze break ring (for 0.01 mg models* ¹ only) | 21 | Pan support boss |
| 5 | Breeze break bottom plate | 22 | Touch screen |
| 6 | Display protection cover (PET plastic)* ² | 23 | Bubble spirit level |
| 7 | Breeze break front glass pane | 24 | Key |
| 8 | Breeze break top glass pane | 25 | Leveling foot |
| 9 | Breeze break left side glass pane | 26 | Serial number |
| 10 | Breeze break right side glass pane | 27 | USB Interface (Type C)* ³ |
| 11 | Breeze break rear glass pane | 28 | RS-232C interface |
| 12 | Quick Start Guide | 29 | AC adapter input jack |
| 13 | AC adapters* ⁵ × 2 pcs | 30 | Grounding terminal |
| 14 | AC adapter ID labels × 2 pcs | 31 | External input terminal |
| 15 | USB cable (approx. 2 m) | 32 | Wired LAN port |
| 16 | Cleaning brushes (large, small) | 33 | USB interface (Type A)* ⁴ |
| 17 | AD-1689 tweezers (for 0.01 mg models* ¹ only) | | |

*¹ BH-225TE/BH-225DTE

*² Attached to the main unit.

*³ For communication only.

*⁴ For USB drive only.

*⁵ Accessories vary depending on the destination region.

2.2. Assembly and installation

⚠ CAUTION

- ❑ Perform the following steps with the AC adapter removed from the main unit.

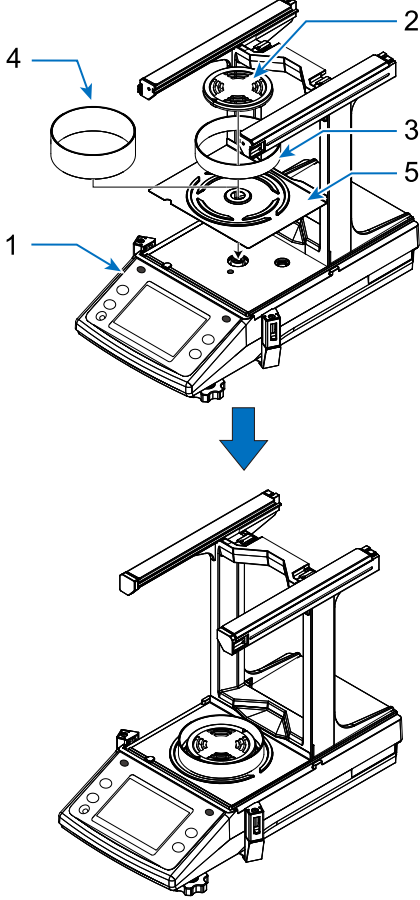
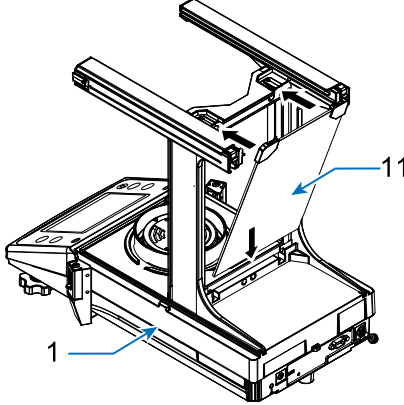
Step	Description	Parts diagram
1	<p>Attach the breeze break bottom plate (5), breeze break ring (3 or 4), and weighing pan (2) to the main unit (1).</p> <p>Tips</p> <ul style="list-style-type: none"> ❑ The high breeze break ring (4) is an accessory exclusive to the 0.01 mg models. Compared to the low breeze break ring (3), the high breeze break ring (4) provides better mitigation against wind and convection effects. However, if the breeze break ring comes into contact with weighing paper or similar items, use the low breeze break ring (3) instead. 	
2	<p>Insert the breeze break rear glass pane (11) into the lower back groove of the main unit (1). Then, push the top of the glass pane into the latches until it clicks into place.</p>	

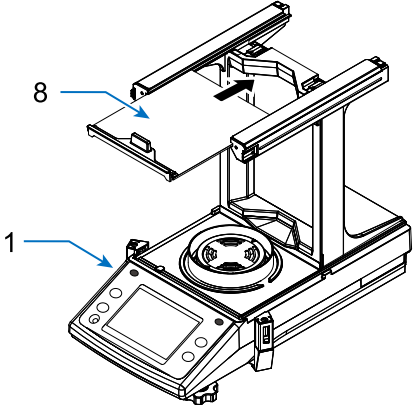
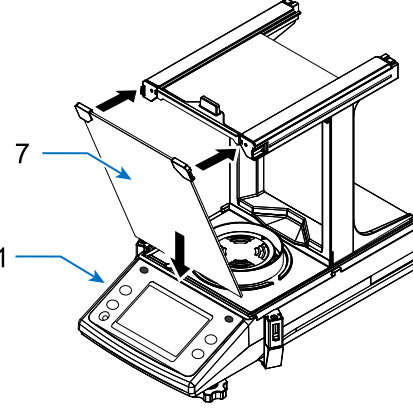
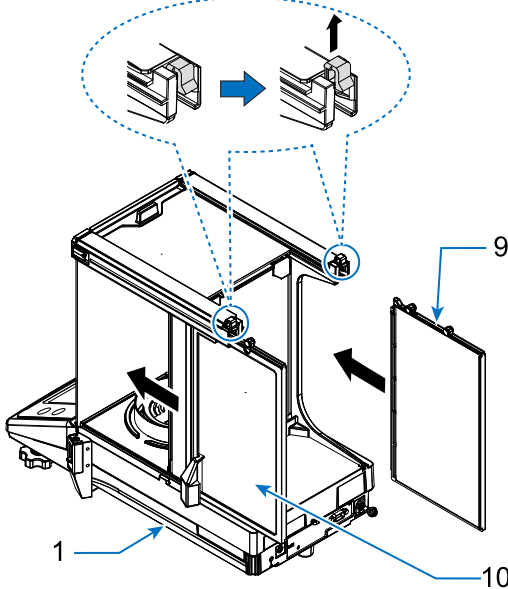
Step	Description	Parts diagram
3	<p>Insert the breeze break top glass pane (8) into the front groove of the breeze break frame from the front of the main unit (1).</p>	
4	<p>Insert the breeze break front glass pane (7) into the lower front groove of the main unit (1), then push the top of the glass pane into the latches until it clicks into place.</p>	
5	<p>For the breeze break side glass panes (9, 10), push the latches on the breeze break frame at the back of the main unit (1) upwards until they click. Insert the glass panes into the grooves of the breeze break frame from the back, ensuring the handles face outward.</p> <p>After inserting the breeze break side glass panes, return the latches to their original position.</p>	

Step	Description	Parts diagram
6	<p>Attach the AC adapter ID labels (14) to the AC adapters (13).</p> <p>⚠ CAUTION</p> <ul style="list-style-type: none"> ❑ Ensure the AC adapter ID labels are attached to avoid using the wrong AC adapters. ❑ Confirm that the AC adapter type is correct for your local voltage and receptacle type. Power consumption: approx. 36 VA (including the AC adapter). ❑ Use only the dedicated AC adapter specified for the balance. ❑ Do not connect the included AC adapter to other devices. ❑ Using the wrong AC adapter may cause the balance and other equipment to malfunction. 	
7	<p>Insert an AC adapter (13) with the attached ID labels (14) into the AC adapter input jack (29) on the back of the main unit (1). Then, plug the other end into an outlet.</p> <p>CAUTION</p> <ul style="list-style-type: none"> ❑ Be sure to warm up the balance for at least an hour before use. 	

2.3. Installation considerations, preparation and precautions

Prepare the following installation conditions in order to bring out the full performance of the balance.

- Install the balance in an environment where the temperature and humidity are not excessive. The best operating temperature is about 20°C ±2°C at about 45% to 60% RH relative humidity.
- Install the balance in a dust-free environment.
- The weighing table should be solid. An anti-vibration table or stone table is ideal.
- Place the balance on a horizontal table, and make sure that it is not tilted.
- Install the balance in a stable location, avoiding areas with vibration and shock. Corners of rooms on the first floor are best, as they are less prone to vibration.
- Avoid installing the balance near equipment such as heaters or air conditioners. You can reduce the influence of breezes and drafts by using an AD-1672/AD-1672A tabletop breeze break.
- Ensure the balance is not exposed to direct sunlight.
- Keep the balance away from equipment that produces magnetic fields.
- Level the balance by adjusting the leveling feet so that the bubble of the bubble spirit level is centered in the black circle. Refer to "[2.4. How to adjust the level of the balance](#)".
- Warm up the balance for at least an hour before use, with the AC adapter connected to the power supply.
- Adjust the sensitivity of the balance before using it for the first time or after having moved it to another location so that accurate weighing can be performed. For how to adjust sensitivity, refer to "[10. \[Sensitivity Adjustment\] Screen](#)".

CAUTION

- Do not install the balance in areas where flammable or corrosive gases are present.

2.4. How to adjust the level of the balance

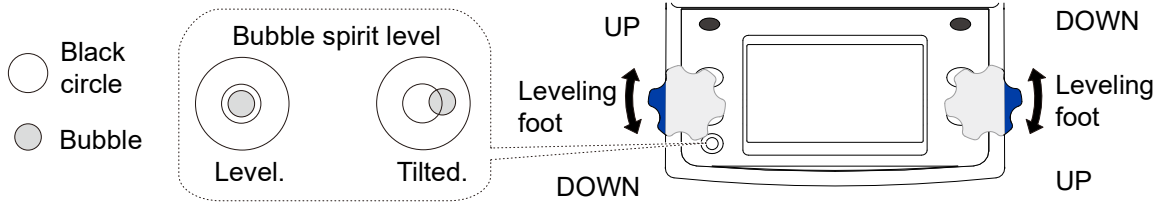

Level the balance by adjusting the leveling feet so that the bubble of the bubble spirit level is centered in the black circle.

When the bubble is off to the left:
Turn the leveling foot on the front right clockwise.

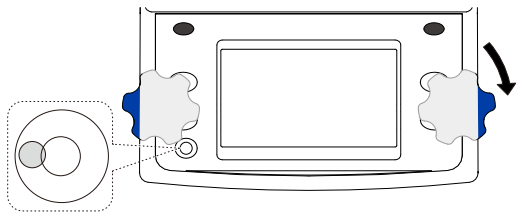

When the bubble is off to the right:
Turn the leveling foot on the front left clockwise.

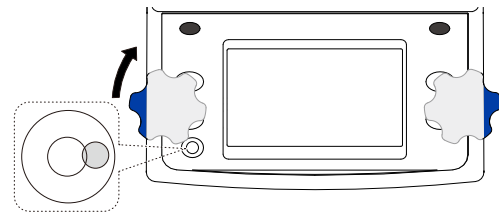

When the bubble is off to the back:
Turn both leveling feet on the front clockwise simultaneously.

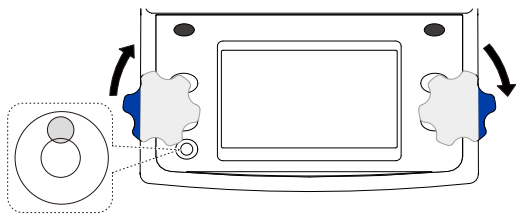

When the bubble is off to the front:
Turn both leveling feet on the front counterclockwise simultaneously.

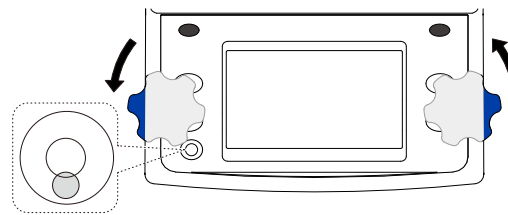

2.5. Precautions during use for more accurate weighing

For precise and accurate weighing, please take notice of the following.

- ❑ Weighing errors may occur due to the influence of static electricity. If the ambient humidity drops below 45% RH, insulators such as plastics are prone to static electricity. Ground the balance using the grounding terminal and perform the following actions as needed.
- ❑ A DC-type ionizer that produces no air currents is available for the BH-T series balances. Refer to "23. Ionizer" and directly remove static electricity from the charged sample.
 - Increase the relative humidity at the location where the balance is installed.
 - Weigh the sample in a conductive metal container or the like.
 - Wipe charged materials, such as plastic, with a damp cloth to suppress static electricity.

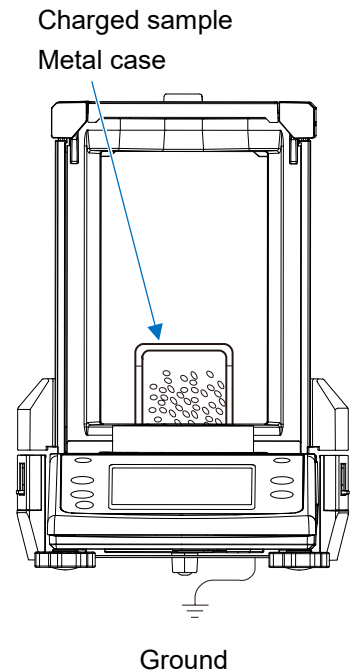

- ❑ Influence of magnetism may cause weighing errors. When measuring magnetic materials (iron, etc.), keep the sample away from the balance main body by means such as underhook weighing.

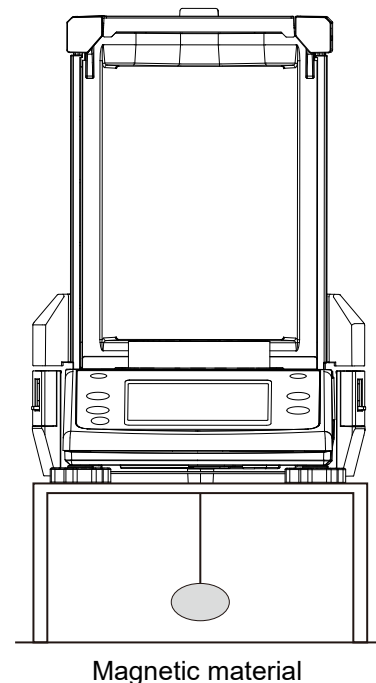

- ❑ Weighing errors may occur if there is a difference between the ambient temperature and temperature of the sample (and the container). For example, when the room temperature is 20 °C, convection occurs around a flask that is 40 °C, causing the balance to display a weight lighter than the actual weight. Before weighing the sample and the container, try to acclimatize them to the ambient temperature.
- ❑ Perform the weighing operation carefully and quickly. If measurement takes a long time, error-inducing factors will increase due to changes in temperature and humidity in the weighing chamber, air turbulence or reaction/humidity absorption by the sample.
- ❑ Do not leave the sample on the weighing pan for an extended period of time. If a sample is left on the weighing pan for a long time, the measured value will change due to deviation from the zero point caused by environmental changes or due to creep phenomenon.
- ❑ When placing a sample on the weighing pan, do not drop it or place a sample that exceeds the balance's weighing capacity. Place the sample in the center of the weighing pan.
- ❑ For weighing where impurities will be a problem, it is advisable to prepare samples outside the weighing chamber in order to prevent the substance from scattering inside the weighing chamber.
- ❑ When pressing the touch screen or keys, do not press with a sharp object such as a pen. Instead, press the center of the key with your finger.
- ❑ Be sure to press the [RE-ZERO] button  before weighing in order to eliminate measurement errors.
- ❑ Measurement results include error from air buoyancy. The buoyancy of air varies depending on the sample volume, atmospheric pressure, temperature, and humidity. Correct the buoyancy for the most precise measurement.
- ❑ Prevent foreign substances such as powder, liquid, and metal pieces from entering the balance.

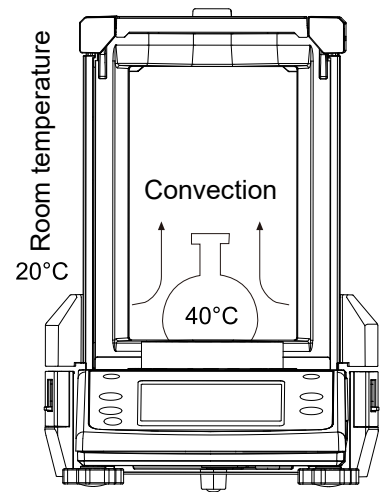

DON'T

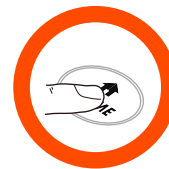

DO



DON'T

2.6. Precautions after weighing (maintenance of the balance)

- ❑ Refer to "24. Maintenance" for maintenance.
- ❑ Avoid exposing the balance to mechanical shocks or dropping it.
- ❑ Do not disassemble the balance.
- ❑ Do not use organic solvents or chemical cleaning cloths to clean the balance. Clean the balance with a lint-free cloth moistened with a mild detergent.
- ❑ When cleaning the weighing pan, be careful not to injure your hands on the edges.

2.7. Caution on the power supply

- ❑ Do not unplug the AC adapter immediately after powering on or during sensitivity adjustment with the internal weight. The internal weight will not be secured and moving the balance may damage its mechanism. When unplugging the AC adapter, always press the [ON:OFF] key and ensure the display shows zero.
- ❑ The balance is constantly provided with power if the AC adapter is connected. The balance is not adversely affected in this state.
For accurate weighing, it is advisable to power on the balance at least an hour before use.

3. Screen and Operation (Keys and Buttons)

3.1. Standby screen

- With the "Standby" screen displayed, press the [ON:OFF] key  or touch the screen to transition to the weighing screen.

On the "Standby" screen, selecting other keys will transition to that screen.

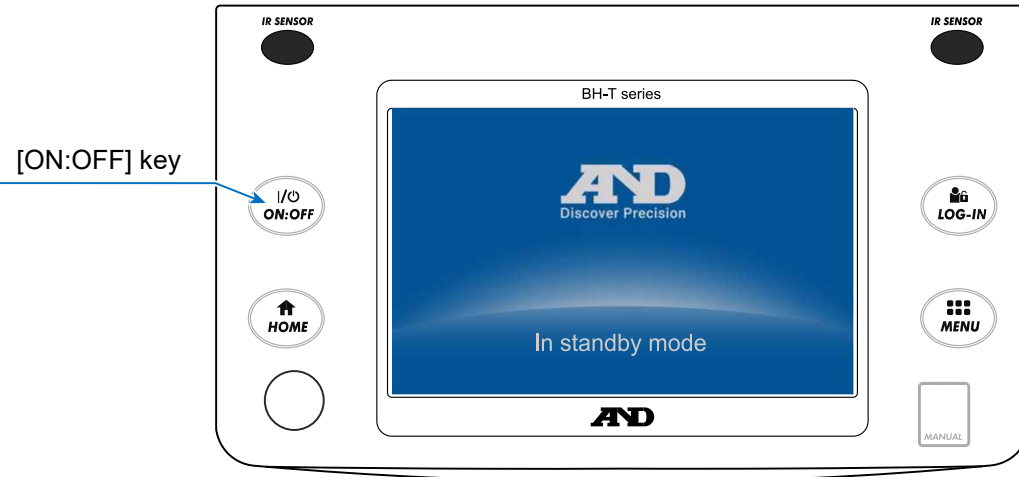

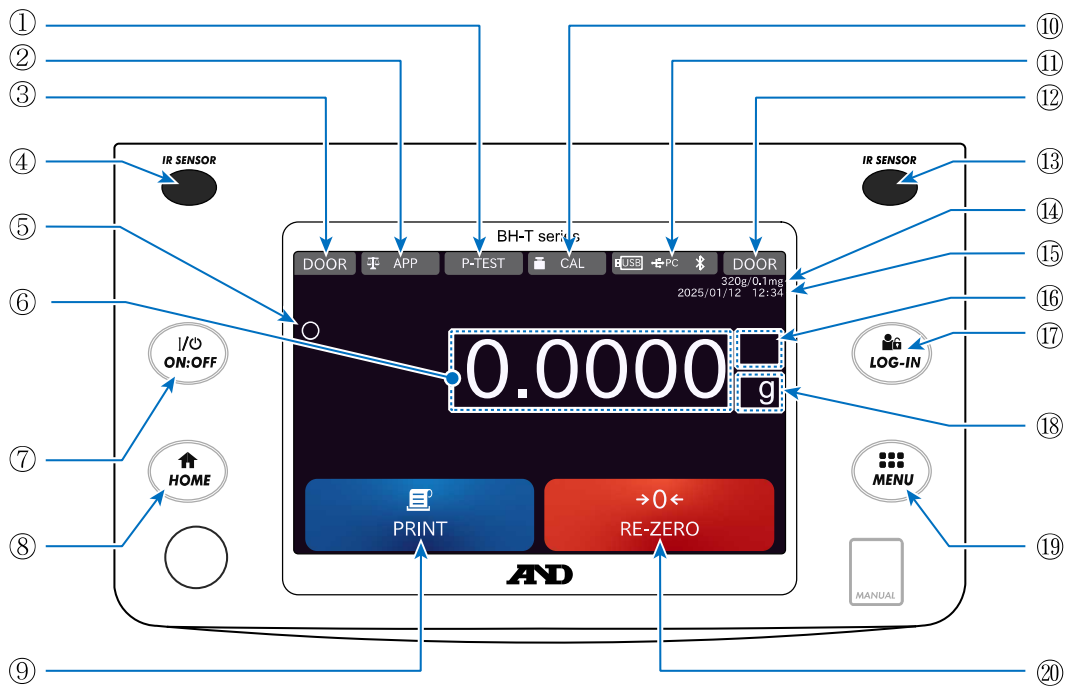

3.2. [HOME] screen (weighing screen)



Key/button operation

No.	Name	Description
(1)	[P-TEST] button	The [Quick Performance Check] button executes the Quick Performance Test. The Quick Performance Test automatically checks the balance's performance by loading and unloading the internal weight. Refer to "6. Quick Performance Check: [Repeatability Measurement] Screen ".
(2)	[APP] button	This application button displays the " Application " settings screen and saves settings related to weighing. Main items: Application selection (normal weighing, piece counting, % weighing, etc.), weighing unit, minimum display digit, statistical calculation function, decimal point, warning display, etc. Refer to " 5. Application ".
(3)	[Left IR sensor function change] button	Displays the options for changing the IR sensor operation settings. You can configure the settings individually for the left and right IR sensors. At the factory setting, they open/close the breeze break door.
(4)	Left IR sensor	A touchless sensor. When you bring your hand closer, it reacts and the assigned breeze break door opens/closes (at factory settings). Refer to " 4. IR Sensors and Auto Doors ".
(5)	Stabilization indicator	Appears when the weighing value of the balance is stable.
(6)	Weighing display	Displays the weighing value of the balance.
(7)	[ON:OFF] key	Turns the screen display on and off. The [ON:OFF] key is active during any operation. When the displayed screen is turned off, the standby screen appears. When the screen display is turned on, the weighing screen appears.
(8)	[HOME] key	Displays the weighing screen. The [HOME] key is active during any operation.
(9)	[PRINT] button	Outputs data to the device connected to the balance. Refer to " 16. Connection with Peripheral Devices " and " 19. Data Output ".
(10)	[CAL] button	This [Sensitivity adjustment] button displays the [Sensitivity adjustment/calibration test] screen. Select and execute the sensitivity adjustment/calibration test with the internal or external weight. Refer to " 10. [Sensitivity Adjustment] Screen ".
(11)	[Communication device setting] button	Displays the [Communication device] screen (" 7. Communication Device "). Configure the settings or remove the connected communication device.
(12)	[Right IR sensor function change] button	Displays the options for changing the IR sensor operation settings. You can configure the settings individually for the left and right IR sensors. At the factory setting, they open/close the breeze break door.
(13)	Right IR sensor	A touchless sensor. When you bring your hand closer, it reacts and the assigned breeze break door opens/closes (at factory settings). Refer to " 4. IR Sensors and Auto Doors ".
(14)	Capacity, readability	Displays the capacity and readability of the balance.
(15)	Date/time display	Displays the current date and time.
(16)	Warning display	Refer to the next page and " 5.12. Warning display ".

No.	Name	Description
(17)	[LOG-IN] key	Displays the [Log-in] screen (" 8.1. [Log-in] screen "). The [LOG-IN] key is active at any time, and pressing the [LOG-IN] key during operation always displays the [Log-in] screen. For details, refer to " 8. Password Function ".
(18)	Unit display	Displays the set unit.
(19)	[MENU] key	Displays the [MENU] screen (" 9. [MENU] Screen "). The [MENU] key is active during any operation.
(20)	[RE-ZERO] button	Sets the displayed value to zero.

No.	Warning display	Name	Description	Display priority
(16)		Shock indicator	Displayed by the shock detection function.	High
		Static elimination recommended	Displayed when the humidity inside the balance is 45% or less. (Lights up for about 30 seconds after the start of weighing)	Low

3.3. On-screen operation buttons

- You can perform main operations for the balance on the touch screen of the display unit.
Touch the on-screen buttons, buttons with text, and [Selection] buttons for operation.

CAUTION

- There are no double-click, drag or flip operations.
Do not perform these operations as they may result in wrong operations.
- Touch buttons with your finger, but not with a hard object.

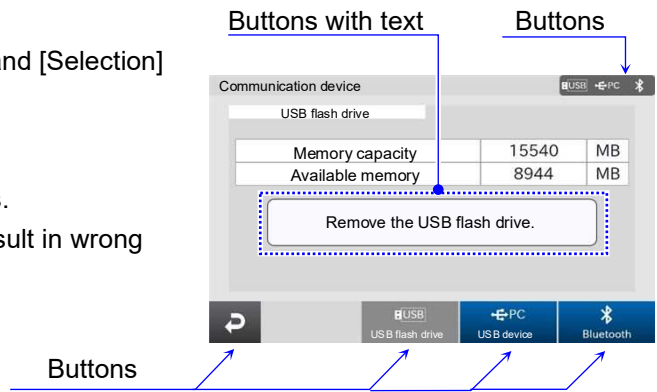

Operation example

- Touch the [Back] button to return to the previous screen.
- Touch a button with text to execute an input or operation that corresponds to the text.
- Touch a [Selection] button to display selections.

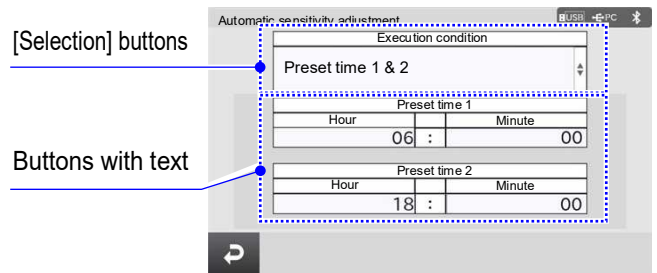

3.4. Input screen

3.4.1. Numerical value input screen

- A numerical value input screen is displayed when you need to input numerical values.

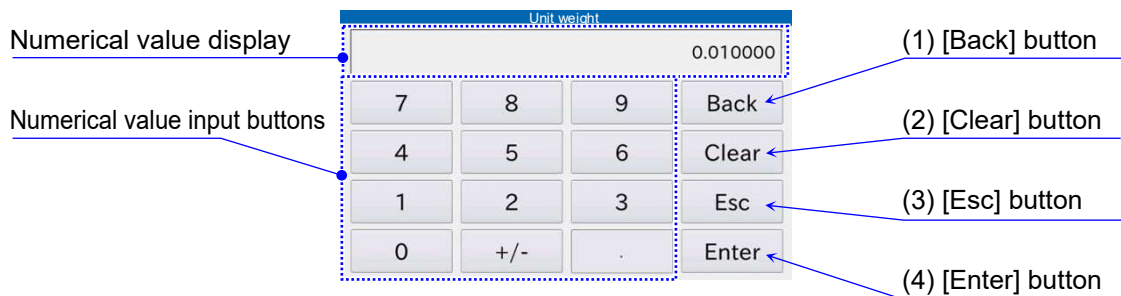

	Name	Description
(1)	[Back] button	Deletes the number right before the cursor.
(2)	[Clear] button	Deletes all input numbers.
(3)	[Esc] button	Returns to the original screen without reflecting the input numerical value.
(4)	[Enter] button	Touch this button after entering a numerical value to reflect the numerical value and return to the original screen. However, if the numerical value is out of range, touching this button returns to the original screen without applying the numerical value.

3.4.2. [Character input] screen

- A [Character input] screen is displayed when you need to input characters.
On the [Character input] screen, you can input alphanumerics and symbols.

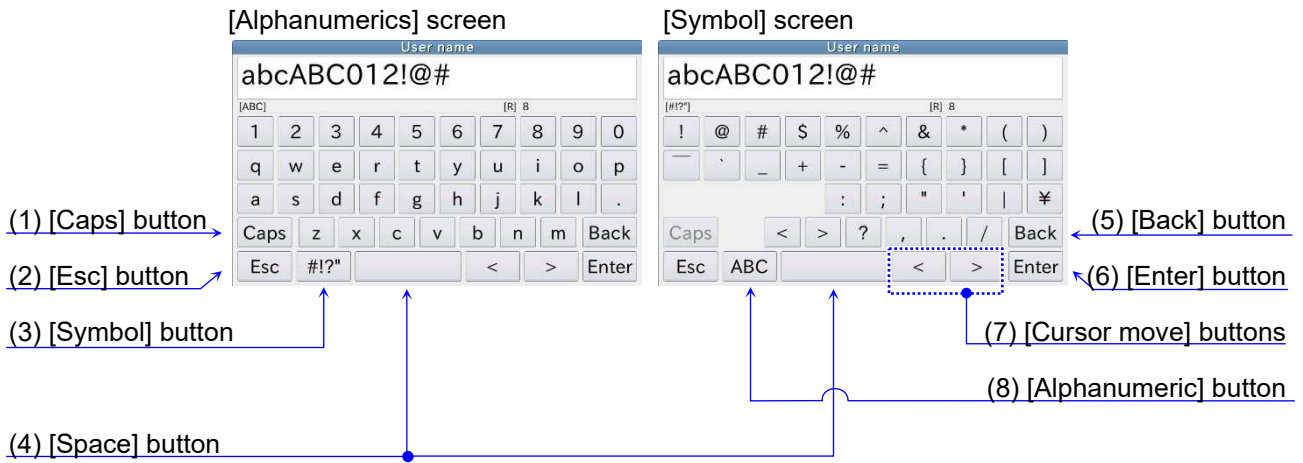

	Name	Description
(1)	[Caps] button	Switches between lower and upper cases.
(2)	[Esc] button	Returns to the original screen without reflecting the input characters.
(3)	[Symbol] button	Keys for inputting characters change to symbols.
(4)	[Space] button	Inputs space characters (space, ASCII 20h).
(5)	[Back] button	Deletes the character right before the cursor.
(6)	[Enter] button	Touch this button after entering a character value to reflect the character value and return to the original screen.
(7)	[Cursor move] buttons	Move the input cursor.
(8)	[Alphanumeric] button	Keys for inputting characters change to alphanumerics.

3.4.3. [Password input] screen

- A [Password input] screen is displayed when you need to input a password. On the [Password input] screen, you can input alphanumerics and symbols. Basic operations are the same as with the [Character input] screen, but the input characters are displayed as "*".

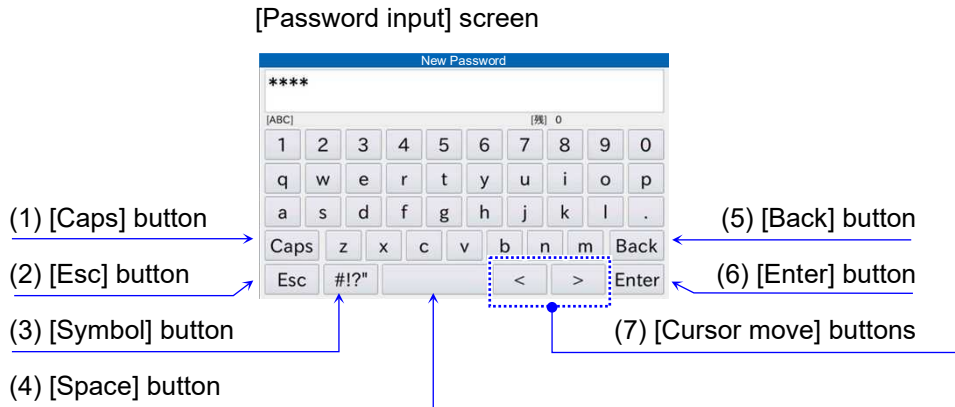

	Name	Description
(1)	[Caps] button	Switches between lower and upper cases.
(2)	[Esc] button	Returns to the original screen without reflecting the input characters.
(3)	[Symbol] button	Keys for inputting characters change to symbols.
(4)	[Space] button	Inputs space characters (space, ASCII 20h).
(5)	[Back] button	Deletes the character right before the cursor.
(6)	[Enter] button	Touch this button after entering a character value to reflect the character value and return to the original screen.
(7)	[Cursor move] buttons	Move the input cursor.



4. IR Sensors and Auto Doors

4.1. IR sensors

BH-T series analytical balances are equipped with IR sensors that allow operation without directly touching the balance display.

At factory settings, the IR sensors on the left and right of the display are assigned to open and close the breeze break doors.



You can turn the left and right IR sensors on and off or change them to operate other functions by using the [Left IR sensor function change] button **DOOR** and the [Right IR sensor function change] button **DOOR**. For details, refer to "[13.2. IR sensors](#)".

Settings screen: [MENU] key  > [System Settings] button  > [IR sensors] button  > [IR sensors] settings screen.



4.2. Auto doors

- ❑ The BH-T series balances feature a breeze break with auto doors that can be opened and closed without touching them.
- ❑ At factory settings, each breeze break door opens to the position it was previously opened to. You can also change the setting in the breeze break auto door settings screen so that the doors are fully open or partially open. Additionally, if you change the connection(s) of the joint(s), it is advisable to perform an auto-door check with the function table.

For details, refer to "[13.3. Breeze break auto doors](#)".

Display settings: [MENU] key  > [System Settings] button  > [Auto doors] button  > [Auto doors] settings screen.

- ❑ You can also open and close the breeze break doors with the external switch AX-SW137-PRINT (or AX-SW137-REZERO) connected to the display unit connection terminal EXT.SW and in the [External input switch] screen. Refer to "[13.23. External input switch](#)".

Display settings: [MENU] key  > [System Settings] button  > [External input switch] button  > [External input switch] screen.

Opening the breeze break door(s)

Step	Description
1	When the breeze break is closed, place your hand over the right (or left) IR sensor.
2	The detection buzzer sounds, and the breeze break door(s) with the joint(s) and handle(s) connected open.

Closing the breeze break door(s)

Step	Description
1	When the breeze break is open, place your hand over the right (or left) IR sensor.
2	The detection buzzer sounds, and the breeze break door(s) with the joint(s) and handle(s) connected close.

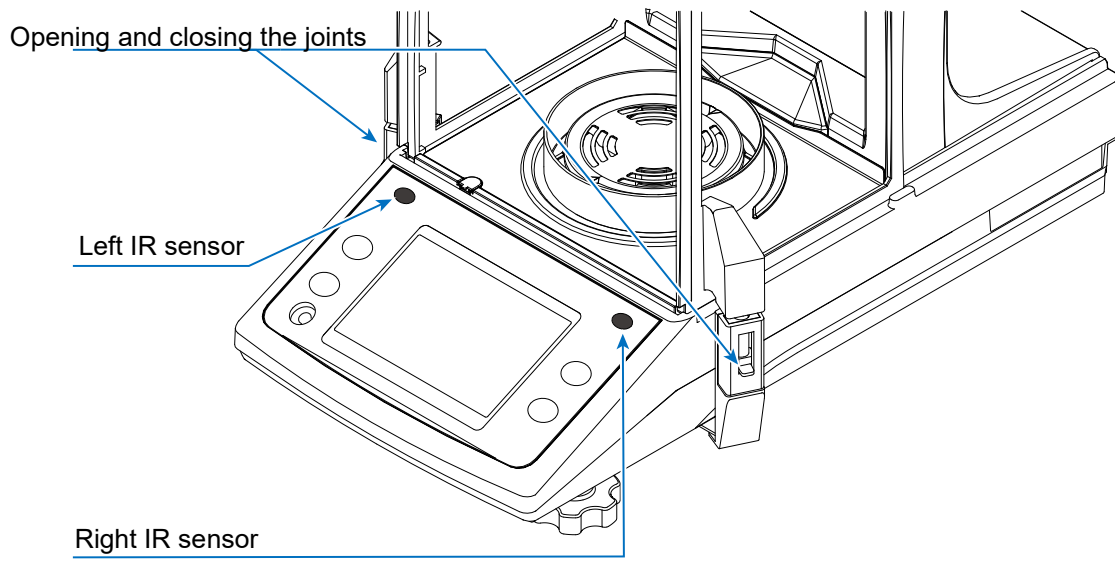

Operation example



5. Application

5.1. [Application] settings screen

- The [Application] settings screen saves the settings related to weighing.

Display settings: [HOME] key  > [APP] button  > [Application] settings screen.

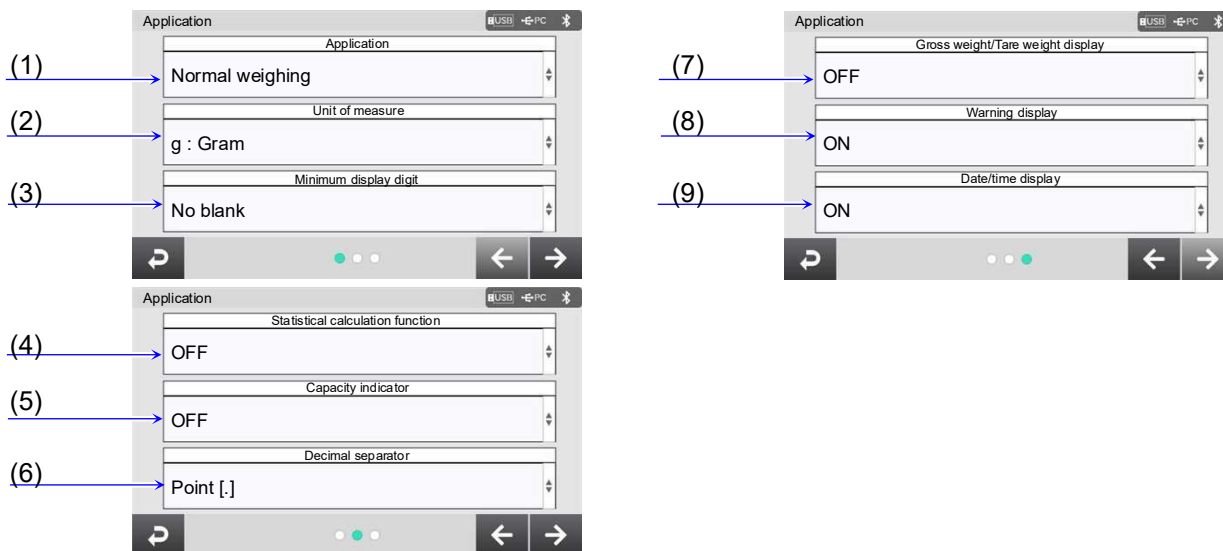

	Name	Setting value (setting range)	Description
(1)	Application selection	Normal weighing , Counting mode, Percent mode, Minimum weight alert function, Formulation mode, HPLC mode, Density measurement mode	Select the application to be used in the weighing screen.
(2)	Unit of measure	g: Gram mg: Milligram (Refer to "5.1.1. Unit of measure".)	Select the unit of measure to be used in the normal weighing.
(3)	Minimum display digit	No blank 1-digit blank 2-digit blank	Select the minimum digit to be displayed for the normal weighing and minimum weight alert function. The 0.1 mg model does not display 2-digit blank.
(4)	Statistical calculation function	OFF , ON	Displays and outputs the statistical calculation result.
(5)	Capacity indicator	OFF , ON	Displays weighing values in a bar graph.
(6)	Decimal separator	Point [.] , Comma [.]	
(7)	Gross weight/Tare weight display	OFF , ON	Select to display the net/gross/tare function.
(8)	Warning display	OFF, ON	
(9)	Date/time display	OFF, ON	

Settings in the red box are default values (factory settings).

5.1.1. Unit of measure

Available units of measure are configured before shipment.

For details about units of measure, refer to the table below.

The table below shows details about the units (modes) available.

Unit / mode	Abbrev.	Conversion to grams 1 g =
Gram	g	1 g
Milligram	mg	0.001 g
Ounce (Avoir)	OZ	28.349523125 g
Troy Ounce	Ozt	31.1034768 g
Metric Carat	ct	0.2 g
Momme	mom	3.75 g
Pennyweight	dwt	1.55517384 g
Grain (UK)	GN	0.06479891 g
Tael (HK general, Singapore)	TL	37.7994 g
Tael (HK jewelry)		37.429 g
Tael (Taiwan)		37.5 g
Tael (China)		31.25 g
Tola (India)	tol	11.6638038 g
Mesghal	MES	4.6875 g

The tables below indicate the weighing capacity and the readability for each unit, depending on the balance model.

Unit	BH-225TE	
	Precision range	
	Capacity	Readability
Gram	220	0.00001
Milligram	220000	0.01
Ounce (Avoir)	7.76	0.000001
Troy Ounce	7.07	0.000001
Metric Carat	1100	0.0001
Momme	58.7	0.00001
Pennyweight	141.5	0.00001
Grain (UK)	3395	0.0002
Tael (HK general, Singapore)	5.82	0.000001
Tael (HK jewelry)	5.88	0.000001
Tael (Taiwan)	5.87	0.000001
Tael (China)	7.04	0.000001
Tola (India)	18.86	0.000001
Mesghal	46.9	0.00001









Unit	BH-225DTE			
	Precision range		Standard range	
	Capacity	Readability	Capacity	Readability
Gram	51.0	0.00001	220	0.0001
Milligram	51000	0.01	220000	0.1
Ounce (Avoir)	1.80	0.000001	7.76	0.00001
Troy Ounce	1.64	0.000001	7.07	0.00001
Metric Carat	255	0.0001	1100	0.001
Momme	13.6	0.00001	58.7	0.0001
Pennyweight	32.8	0.00001	141.5	0.0001
Grain (UK)	787	0.0002	3395	0.001
Tael (HK general, Singapore)	1.35	0.000001	5.82	0.00001
Tael (HK jewelry)	1.36	0.000001	5.88	0.00001
Tael (Taiwan)	1.36	0.000001	5.87	0.00001
Tael (China)	1.63	0.000001	7.04	0.00001
Tola (India)	4.37	0.000001	18.86	0.00001
Mesghal	10.9	0.00001	46.9	0.0001

Unit	BH-224	BH-324	Readability
	Capacity		
Gram	220	320	0.0001
Milligram	220000	320000	0.1
Ounce (Avoir)	7.76	11.29	0.00001
Troy Ounce	7.07	10.29	0.00001
Metric Carat	1100	1600	0.001
Momme	58.7	85.3	0.0001
Pennyweight	141.5	205.8	0.0001
Grain (UK)	3395	4938	0.002
Tael (HK general, Singapore)	5.82	8.47	0.00001
Tael (HK jewelry)	5.88	8.55	0.00001
Tael (Taiwan)	5.87	8.53	0.00001
Tael (China)	7.04	10.24	0.00001
Tola (India)	18.86	27.44	0.00001
Mesghal	46.9	68.3	0.0001



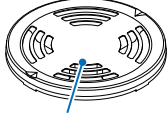

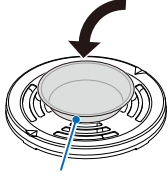
5.2. Normal weighing

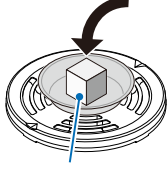
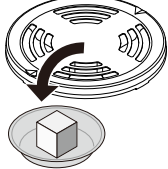
5.2.1. Basic weighing

Example: Weighing (in grams) with BH-224TE

Step	Description	Display and key operations	Weighing operation
1	Press the [ON:OFF] key  or the [HOME] key  to enter weighing mode.	 or 	 Weighing pan
2	Place a container (tare) on the weighing pan if necessary. Press the [RE-ZERO] button  to set the weighing value to zero. (The decimal separator position depends on the balance model.)	 Zero display	 Container (tare)
3	Place a sample on the pan or in the container. Wait for the stabilization indicator to be displayed. Read the value.	 Weighing value	 Sample
4	Remove the sample and container from the weighing pan.		

Zero after subtracting the tare

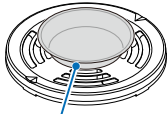
Step	Description	Display and key operations	Weighing operation
1	<p>If you press the [ON:OFF] key  with a container (tare) placed on the weighing pan to display the weighing value, zero is displayed after automatically subtracting the tare. (Zero display after subtracting the tare)</p> <p>CAUTION</p> <ul style="list-style-type: none"> ❑ In the zero display after subtracting the tare, the range available for weighing becomes narrower than the maximum display (capacity). Range available for weighing = Maximum display - Tare weight ❑ For details about the range available for weighing up to the capacity in the zero display during sensitivity adjustment when the screen display is turned on, refer to "5.2.2. Zero-point, tare, and weighing range". 	  	 <p>Container (tare)</p>

5.2.2. Zero-point, tare, and weighing range

Entering the weighing mode

- The balance will determine the reference zero point when the [ON:OFF] key  is pressed to enter the weighing mode.

Depending on the load condition at that time, the balance automatically judges whether to set the zero-point or to tare.

The condition for determining which is used is the "power-on zero range", and when the power-on zero range is exceeded, the tare operation is performed.

Re-zero operation

- By pressing the [RE-ZERO] button , the displayed value can be set to zero.

The re-zero operation with the [RE-ZERO] button  will automatically judge whether to set the zero-point or to tare.

Weighing range

- The weight range that the balance can display varies depending on the model. When the gross weight weighed exceeds the maximum display, "E" is displayed to indicate that the weighing range is exceeded. When exceeded in the negative direction, "-E" is displayed.

Gross weight = Net weight (weighing value minus tare) + Tare weight

Model	Power-on zero range	Zero range	-E display range
BH-225TE / BH-225DTE	Approx. ±22 g	Approx. -22 g to ±4.4 g	Approx. -22 g
BH-324TE	Approx. ±32 g	Approx. -32 g to ±6.4 g	Approx. -32 g
BH-224TE	Approx. ±22 g	Approx. -22 g to ±4.4 g	Approx. -22 g



5.2.3. Smart range function

- ❑ For BH-225DTE, there are two types of ranges: the standard range and precision range (high resolution).

Smart range function









- ❑ The range can switch automatically between the standard range and precision range (high resolution), depending on the value displayed.

Pressing the [RE-ZERO] button  to set the displayed value to zero allows for weighing in the precision range, regardless of the tare value. The range can be fixed to the standard range by using [Minimum display digit] in the [Application] settings screen.

Display settings: [HOME] key  > [APP] button  > [Application] settings screen > [Minimum display digit] button > Select from [No blank], [1 digit blank], [2 digit blank].

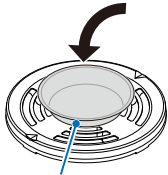
Operation example

Example weighing in grams for BH-225DTE

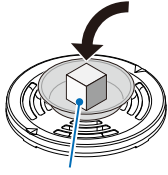
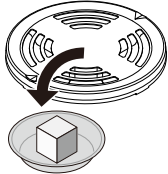

Step	Description	Display and key operations	Weighing operation
1	Start weighing in the precision range. Press the [RE-ZERO] button  to set the display to zero and enable the precision range.	 Zero display Precision range	 Weighing pan
2	Place a container. When the displayed value exceeds the precision range, the balance automatically switches to the standard range.	 Standard range	 Container (tare)
3	Press the [RE-ZERO] button  to set the display to zero and enable the precision range.	 Zero display Precision range	
4	Place a sample. If the weighing value does not exceed the precision range, the sample can be weighed in the precision range.	 Precision range	 Sample
5	Remove the sample and container from the weighing pan.		 Nothing on the pan

Precision range and standard range

Model	Unit	Precision range after pressing the [RE-ZERO] button 	Standard range
BH-225DTE	Gram (g)	0.00000 g to 51.00009 g	51.0001 g to 220.0008 g
	Milligram (mg)	0.00 mg to 51000.09 mg	51000.1 mg to 220000.8 mg

5.3. Counting mode (PCS)

- If you configure this display, the [HOME] screen changes to Counting mode.

Display settings: [HOME] key  > [APP] button  > [Application] settings screen > [Application selection] button > Select [Counting mode].
 [HOME] key  > [Counting mode] screen.

(1) Counting mode display

(2) [Unit weight setting] button

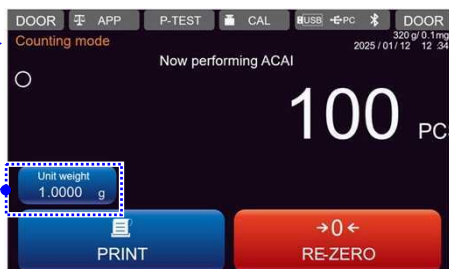

	Name	Description
(1)	Counting mode display	Displayed in the Counting mode.
(2)	[Unit weight setting] button	Displays the [Counting mode setting] screen described in "5.3.1. Storing a unit weight: [Counting mode setting] screen", where the stored unit weight is displayed. You can also change the unit weight.



Counting mode usage

- This is the mode to determine the number of objects in a sample. Based on the reference sample unit weight (weight per piece), the balance calculates and displays how many pieces the sample weight corresponds to. The smaller the variation in the unit weight of sample pieces is, the more accurate the count will be. The balance is equipped with the Automatic Counting Accuracy Improvement (ACAI) function to improve the counting accuracy.

Note:

- It is recommended that the unit weight (weight per piece) of the sample should be 1 mg or more.
- If there is a large variation in the unit weight of sample pieces, it may not be possible to count accurately.
- If a large error is found in the counting measurement, try a method such as performing ACAI frequently or multiple measurements.

5.3.1. Storing a unit weight: [Counting mode setting] screen

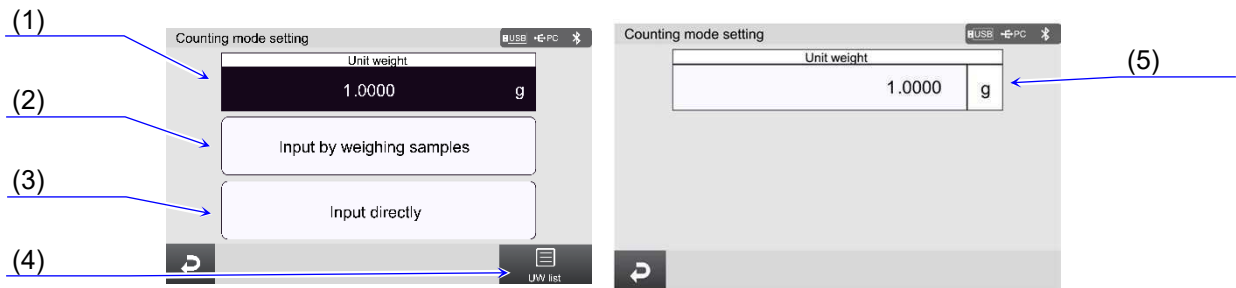

Display settings: [HOME] key  > [APP] button  > [Application] settings screen > [Application selection] button > Select [Counting mode].
 [HOME] key  > [Counting mode] screen > [Unit weight setting] button > Unit weight [Counting mode setting] screen.



	Name	Description
(1)	Unit weight display	Displays the unit weight through the direct input or input by weighing samples.
(2)	[Input by weighing samples] button	Displays the Counting mode [Sample input mode] screen (" 5.3.2. Counting mode sample input: [Sample input mode] screen ").
(3)	[Input directly] button	Displays the numerical value input screen for the unit weight.
(4)	[UW list] button	Displays the [Unit weight list] screen (" 5.3.4. Unit weight list ").
(5)	[Unit weight] input button	Input the unit weight. Input range: 0.1 mg to capacity for each model

❑ This screen is used to store the unit weight for the Counting mode.

5.3.2. Counting mode sample input: [Sample input mode] screen

Display settings: [HOME] key  > [APP] button  > [Application] settings screen > [Application selection] button > Select [Counting mode].
 [HOME] key  > [Counting mode] screen > [Unit weight setting] button > [Input by weighing samples] button > Counting mode [Sample input mode] screen.

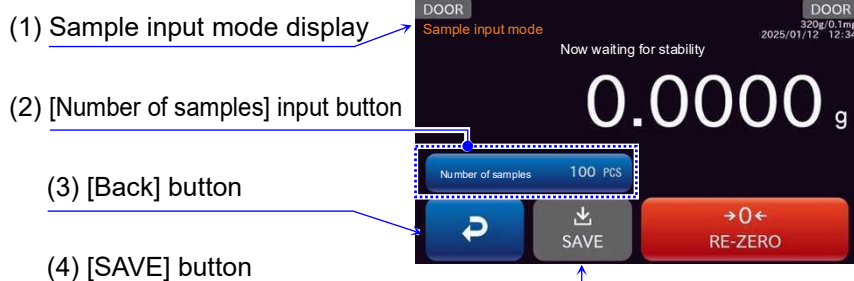





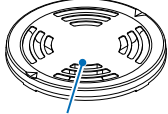

	Name	Description
(1)	Sample input mode display	Displayed in the Counting mode sample input mode.
(2)	[Number of samples] input button	Input the number of samples for the input by weighing samples. Input range: 10 - 10000 pcs
(3)	[Back] button	Displays the [Counting mode] screen (" 5.3. Counting mode (PCS) ").
(4)	[SAVE] button	Store the unit weight based on the current weight value and number of samples.

❑ This screen is used to input the unit weight by weighing samples for the Counting mode.

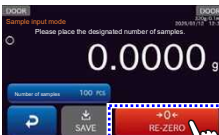
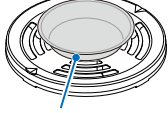
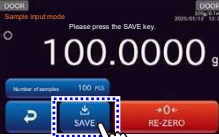
How to store the unit weight

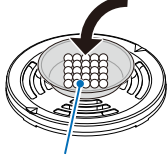
Example: Counting with BH-324TE

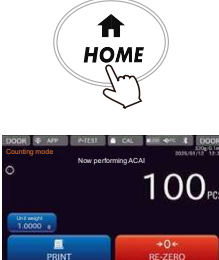
Step	Description	Display and key operations	Weighing operation
1	<p>Press the [Number of samples] input button.</p> <p>Note that a greater number of sample pieces will yield more accurate counting result since the sample unit weight is usually considered to vary more or less.</p>	 <p>Numerical value input screen for inputting the number of samples</p>	 <p>Weighing pan</p>
2	<p>Place a container on the weighing pan and press the [RE-ZERO] button  to set the weighing value to zero.</p>	 <p>Zero display</p>	 <p>Container (tare)</p>
3	<p>Place the specified number of sample pieces on the container/weighing pan.</p>	 <p>Weighing value</p>	<p>Weighing with the specified number of samples.</p>
4	<p>Press the [SAVE] button . When "The unit weight has been stored." is displayed, the storage is complete.</p> <p>CAUTION</p> <p>❑ If the balance judges that the unit weight is too light to be stored, the [SAVE] button  is disabled.</p>	 <p>Sample</p>	
5	<p>Press the [HOME] key  to return to the Counting mode screen.</p>		

❑ The stored unit weight is stored in nonvolatile memory even if the power is removed.

5.3.3. ACAI function

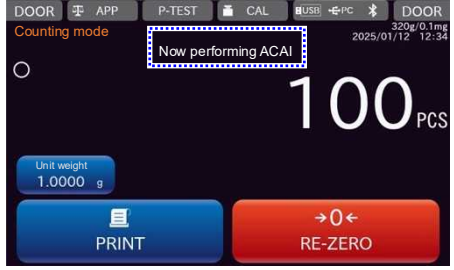

The ACAI function automatically improves the counting accuracy each time the number of sample pieces is increased.

Errors will be reduced as variations in sample weight are averaged.

Step	Description	Display and key operations
1	<p>After storing the unit weight through the input by weighing samples and adding some sample pieces in the Counting mode screen, "Now performing ACAI" (updating the counting precision) is displayed.</p> <p>Caution on how to add sample pieces</p> <ul style="list-style-type: none"> ❑ Add three or more sample pieces to prevent malfunction. The function does not turn on with too many sample pieces on the weighing pan. Add approximately the same number of sample pieces as displayed. 	
2	<p>While "Now performing ACAI" (updating the counting precision) is displayed, do not move sample pieces.</p>	
3	<p>"ACAI has been performed" is displayed and the precision is updated. Each time this process is repeated, the counting accuracy will improve further. The range of ACAI after exceeding 100 is not predetermined. Add approximately the same number of sample pieces as displayed.</p>	
4	<p>Remove all the sample pieces used with ACAI from the weighing pan and start counting work.</p>	

- ❑ ACAI does not function if the displayed value is set to zero, for example, by pressing the [RE-ZERO] button .
- ❑ If the unit weight is stored through the unit weight input field, the ACAI function is not activated.

5.3.4. Unit weight list

Display settings: [HOME] key  > [APP] button  > [Application] settings screen > [Application selection] button > Select [Counting mode].



[HOME] key  > [Counting mode] screen > [Unit weight setting] button > [UW list] button > [Unit weight list] screen.



	Name	Description
(1)	Unit weight list	Displays the stored unit weights.
(2)	[Back] button	Displays the [Counting mode setting] screen (" 5.3.2. Counting mode sample input: [Sample input mode] screen ").
(3)	[Edit] button	Edits the data for the unit weight selected in the unit weight list. Displays the [Counting mode setting] screen (" 5.3.5. Editing and storing a unit weight: [Counting mode setting] screen ").
(4)	[Page navigation] buttons	Used to navigate the unit weight list page.
(5)	[Page number change] button	Changes the number of the unit weight list page. Input range: 1-9
(6)	[Settings] button	Sets the unit weight data selected in the unit weight list as the unit weight to be used.
(7)	[Delete] button	Deletes the data of the unit weight selected in the unit weight list to return it to the initial value. Initial value Name: Blank Unit weight: 0.0001 g

The unit weight list can store up to 50 unit weights.

5.3.5. Editing and storing a unit weight: [Counting mode setting] screen

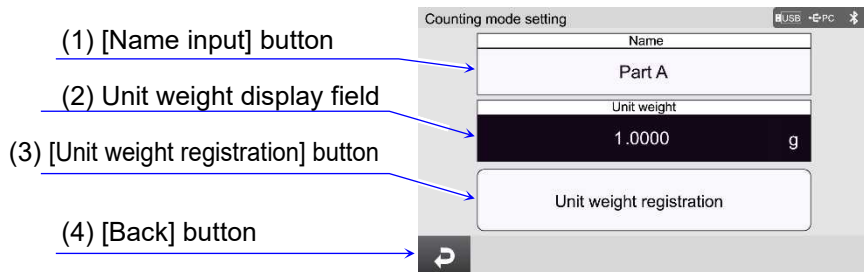

Display settings: [HOME] key  > [APP] button  > [Application] settings screen > [Application selection] button > Select [Counting mode].
 [HOME] key  > [Counting mode] screen > [UW list] button > [Edit] button > [Counting mode setting] screen for editing and storing a unit weight.



	Name	Description
(1)	[Name input] button	Displays the name of the stored unit weight. A new name can be entered.
(2)	Unit weight display field	Displays the stored unit weights.
(3)	[Unit weight registration] button	Displays the [Counting mode setting] screen where the stored unit weight can be changed (" 5.3.2. Counting mode sample input: [Sample input mode] screen ").
(4)	[Back] button	Displays the [Unit weight list] screen (" 5.3.4. Unit weight list ").

5.4. Percent mode: [Percent weighing] screen

- If you configure this display, the [HOME] screen changes to the Percent mode.

Display settings: [HOME] key  > [APP] button  > [Application] settings screen > [Application selection] button → Select [Percent mode].
 [HOME] key  > [Percent mode] screen.





	Name	Description
(1)	Percent mode display	Displayed in the Percent mode.
(2)	[Percent mode setting] button	Displays the [Percent mode setting] screen (" 5.4.1. Storing a 100% mass: [Percent mode setting] screen "). Also displays the currently stored 100% reference mass.

Percent mode usage

- The percent mode displays the weighing value in a percentage compared with a reference mass as 100%. This is useful for target weighing or sample variance checks.

5.4.1. Storing a 100% mass: [Percent mode setting] screen

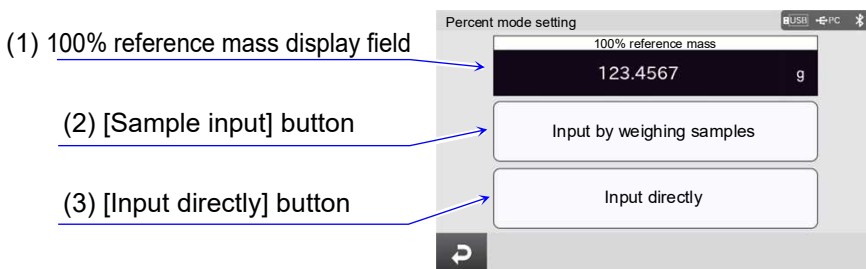

Display settings: [HOME] key  > [APP] button  > [Application] settings screen > [Application selection] button > Select [Percent mode].
 [HOME] key  > [Percent mode setting] screen > [Percent mode setting] button > [Percent mode setting] screen.



	Name	Description
(1)	100% reference mass display field	Displays the 100% reference mass.
(2)	[Sample input] button	Displays the [Sample input mode] screen (" 5.4.2. Percent mode sample input: [Sample input mode] screen ").
(3)	[Input directly] button	Displays the numerical value input display for the 100% reference mass.

- This screen is used to set the 100% reference mass for the Percent mode.

5.4.2. Percent mode sample input: [Sample input mode] screen

Display settings: [HOME] key  > [APP] button  > [Application] settings screen > [Application selection] button → Select [Percent mode].
 [HOME] key  > [Percent mode] screen > [Percent mode setting] button > [Sample input] button > [Sample input mode] screen.

(1) Sample input mode display

(2) [SAVE] button

(3) [Back] button

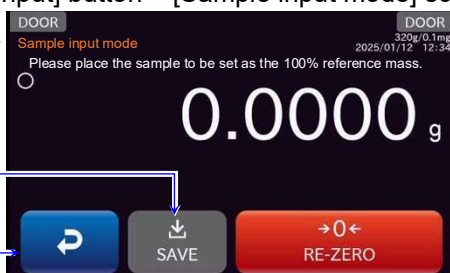







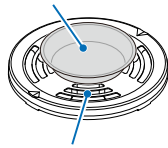
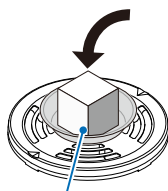

	Name	Description
(1)	Sample input mode display	Displayed in the Percent mode sample input mode.
(2)	[SAVE] button	Stores the 100% reference mass.
(3)	[Back] button	Displays the [Percent mode setting] screen (" 5.4. Percent mode: [Percent weighing] screen ").

❑ This screen is used to input the 100% reference mass for the Percent mode by weighing samples.

How to store the unit weight

Example: Weighing with BH-324TE

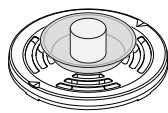
Step	Description	Display and key operations	Weighing operation
1	Place a container on the weighing pan if necessary and press the [RE-ZERO] button  to set the weighing value to zero.	 Zero display	Container (tare)  Weighing pan
2	Place a sample for the 100% reference mass on the weighing pan/container.		
3	Press the [SAVE] button  . "The 100 % reference mass has been stored." is displayed.		100% reference mass sample
4	Press the [HOME] key  to return to the [Percent mode] screen.		
Weighing example	When samples are weighed, the percent is displayed.	 Percent display	 Percent display



CAUTION

- ❑ If the balance judges that the sample reference mass for 100% is too light to be stored, the [SAVE] button  is disabled.
- ❑ The decimal separator position varies according to the 100% reference mass.
- ❑ The stored 100% reference mass is stored in nonvolatile memory even if the power is removed.

Model	100% reference mass	Decimal separator position
BH-225TE / BH-225DTE BH-324TE / BH-224TE	0.0100 g to 0.0999 g	1%
	0.1000 g to 0.9999 g	0.1%
	1.0000 g or greater	0.01%

5.5. Minimum weight alert function

- ❑ If you configure this display, the [HOME] screen changes to the weighing screen with the minimum weight alert function.

Display settings: [HOME] key  > [APP] button  > [Application] settings screen > [Application selection] button > Select [Minimum weight alert function].
 [HOME] key  > Weighing screen with the minimum weight alert function.

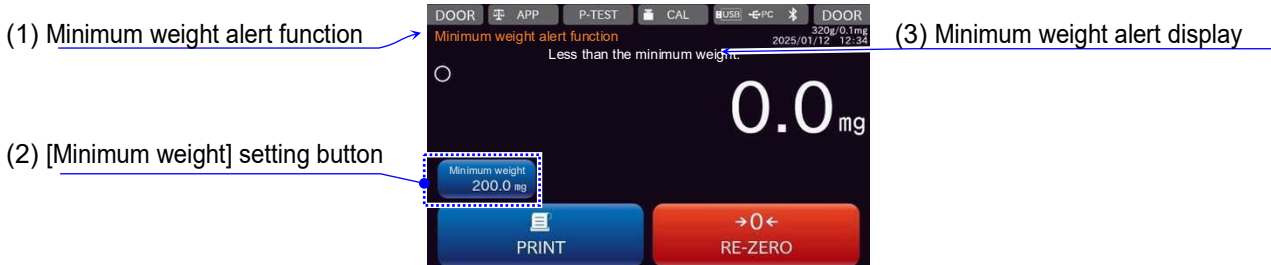



	Name	Description
(1)	Minimum weight alert function	Displayed when the minimum weight alert function is enabled.
(2)	[Minimum weight] setting button	Displays the [Minimum weight setting] screen (" 5.5.1. Minimum weight setting "). Also displays the currently stored minimum weight.
(3)	Minimum weight alert display	Displayed when the sample weight is less than the set minimum weight.

- ❑ This is the screen for the minimum weight alert function. The unit of measure available for this function is milligrams (mg) only.

Minimum weight alert function usage

- ❑ Minimum weight is the minimum sample weight required to perform correct quantitative analysis taking the measurement error of the balance used into account. If the sample amount is too small, the proportion of measurement error in the measured value increases, and the reliability of the analysis result thus may drop.
- ❑ The minimum weight alert function makes it possible to judge immediately whether the sample amount meets the set minimum weight.

5.5.1. Minimum weight setting

Display settings: [HOME] key  > [APP] button  > [Application] settings screen > [Application selection] button > Select [Minimum weight alert function].
 [HOME] key  > Weighing screen with the minimum weight alert function > [Minimum weight] setting button > [Minimum weight setting] screen.

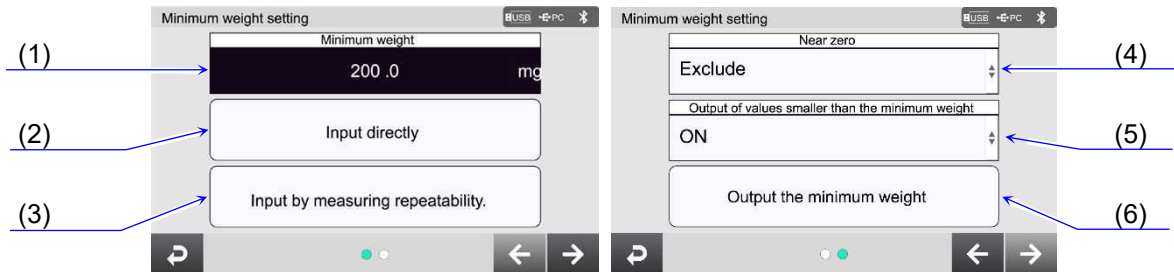



	Name	Setting value	Description
(1)	Minimum weight display	-	Displays the currently stored minimum weight.
(2)	[Input directly] button	-	Displays the [Minimum weight setting] screen ("5.5.2. Minimum weight input: [Minimum weight setting] screen").
(3)	[Input by measuring repeatability] button	-	Displays the [Minimum weight setting] screen for measurement ("5.5.3. Minimum weight setting for measurement").
(4)	Comparison near zero	Include Exclude	Select whether to include or exclude near zero for the minimum weight alert display.*
(5)	Outputting data less than the minimum weight	OFF ON	If set to OFF, data with the weighing value less than the minimum weight is not output.
(6)	[Output the minimum weight] button	-	Outputs the minimum weight.

Settings in the red box are default values (factory settings).

* Near zero is within ± 10 d of 0 mg. "d" represents scale division.

□ This is the screen for setting the minimum weight.

5.5.2. Minimum weight input: [Minimum weight setting] screen

Display settings: [HOME] key  > [APP] button  > [Application] settings screen > [Application selection] button > Select [Minimum weight alert function].
 [HOME] key  > Weighing screen with the minimum weight alert function > [Minimum weight] setting button > [Input directly] button > [Minimum weight setting] screen.

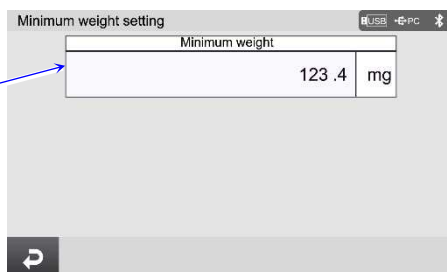

(1) Minimum weight input



	Name	Setting value	Description
(1)	Minimum weight input	0 mg to capacity	Input the minimum weight.

□ This is the screen for inputting the minimum weight.

5.5.3. Minimum weight setting for measurement

Display settings: [HOME] key  > [APP] button  APP > [Application] settings screen > [Application selection] button > Select [Minimum weight alert function].
 [HOME] key  > Weighing screen with the minimum weight alert function > [Minimum weight] setting button > [Input by measuring repeatability] button > [Minimum weight setting] screen.

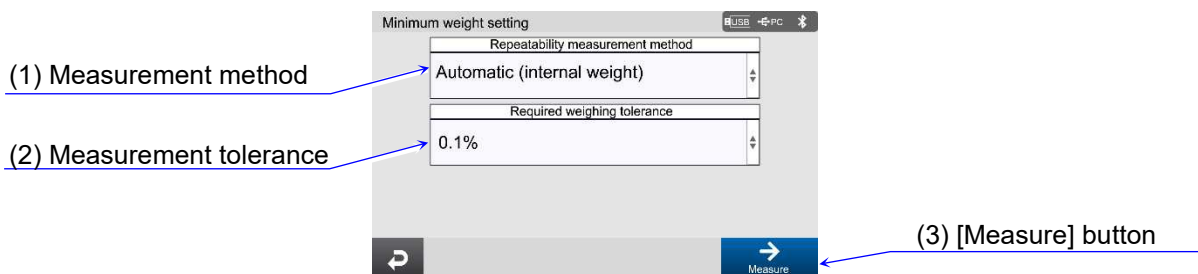

	Name	Setting value	Description
(1)	Repeatability measurement method	Automatic (internal weight) Manual (external weight)	Select the repeatability measurement method.
(2)	Minimum weight measurement tolerance	0.1% 1.0%	Select the minimum weight measurement tolerance.
(3)	[Measure] button	-	Start the minimum weight measurement. When the measurement is complete, the [Minimum weight measurement result] screen described in "5.5.4. Minimum weight measurement result" is displayed.

 Settings in the red box are default values (factory settings).

❑ This is the screen for measuring the minimum weight.

Automatic (internal weight)

When the measurement is complete, the [Minimum weight measurement result] screen described in "5.5.4. Minimum weight measurement result" is displayed.

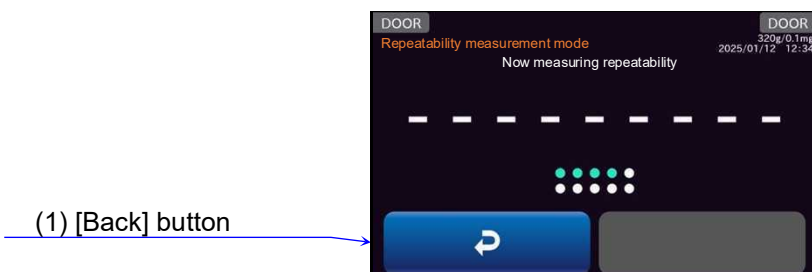







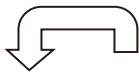
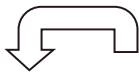

	Name	Description
(1)	[Back] button	Returns to the previous screen.

Manual (external weight)

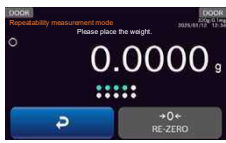
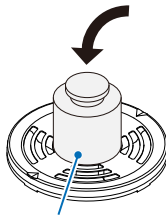

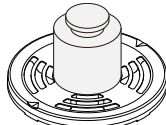
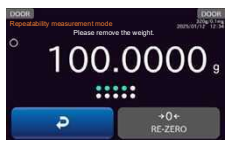
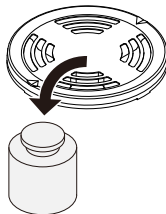
For this setting, measurement is performed with your weight to compute the minimum weight.

The procedure is displayed in the message field.

Example: Weighing with BH-324TE

Step	Description	Display and key operations	Weighing operation
1	Press the [RE-ZERO] button  .		
			 Weighing pan
2	Place the weight.		 Place the weight
3	Remove the weight when the stabilization indicator "○" is displayed.		
			
4	Repeat steps 1, 2 and 3 ten times.		
5	When the measurement is complete, the [Minimum weight measurement result] screen described in "5.5.4. Minimum weight measurement result" is displayed.	 [Minimum weight measurement result] screen.	

5.5.4. Minimum weight measurement result

Display settings: [HOME] key  > [APP] button  > [Application] settings screen > [Application selection] button > Select [Minimum weight alert function].
 [HOME] key  > Weighing screen with the minimum weight alert function > [Minimum weight] setting button > [Input by measuring repeatability] button > [Minimum weight setting] screen > [Measure] button > [Minimum weight measurement result] screen.

- When the measurement is complete, the [Minimum weight measurement result] screen described in "5.5.3. Minimum weight setting for measurement" is displayed.

(1) Measurement method

(2) Measurement tolerance

(3) Repeatability (standard deviation)

(4) Minimum weight

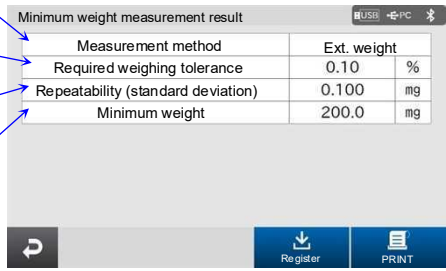

(5) [PRINT] button

(6) [Register] button

	Name	Description
(1)	Measurement method	Displays the method used for the minimum weight measurement.
(2)	Measurement tolerance	Displays the minimum weight measurement tolerance.
(3)	Repeatability (standard deviation)	Displays the standard deviation for this measurement.
(4)	Minimum weight	Displays the minimum weight.
(5)	[PRINT] button	Outputs the minimum weight measurement result to the device connected to the balance.
(6)	[Register] button	Registers the minimum weight.

- ※ If the repeatability (standard deviation) is 0.41 d or less, the minimum weight is 2000 times the 0.41 d in compliance with USP.
 "d" represents scale division.



5.6. Formulation function

Formulation function usage





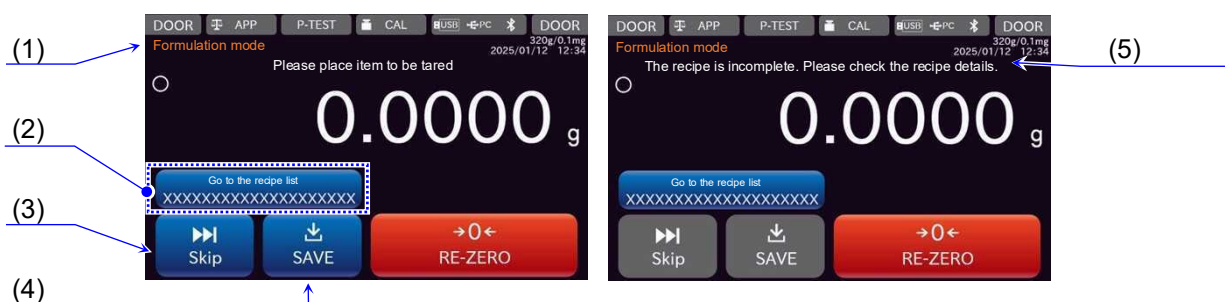

- ❑ This is the function to store a recipe consisting of the sample to be weighed, the target weight, and the tolerance of the amount to be weighed with the balance, and to weigh according to the recipe.
- ❑ If you configure this display, the [HOME] screen changes to formulation mode.

CAUTION

- ❑ The contents of the stored recipes and sample information will be cleared by initializing the balance.



Display settings: [HOME] key  > [APP] button  > [Application] settings screen > [Application selection] button > Select [Formulation mode].
 [HOME] key  > [Formulation mode] screen.



	Name	Description
(1)	Formulation mode	Displayed when in the formulation mode.
(2)	[Go to the recipe list] button	Displays the [Recipe list] screen ("5.6.1. Selecting a recipe"). The name of the currently selected recipe is displayed here.
(3)	[Skip] button 	Skips tare weighing and displays the [Formulation mode - Sample weighing] screen ("5.6.6. Sample weighing screen"). If the recipe is incomplete, the button is disabled.
(4)	[SAVE] button 	Weighs the tare value and displays the [Formulation mode - Sample weighing] screen ("5.6.6. Sample weighing screen"). If the recipe is incomplete, the [SAVE] button  is disabled. If the weighing value is negative, it is recorded as 0 g.
(5)	Display indicating that the recipe is incomplete	If the selected recipe is incomplete: The message "The recipe is incomplete. Please check the recipe details." is displayed and the [Skip] button  and [SAVE] button  are disabled. Check the recipe name and the target value and tolerance of the sample registered in the recipe. If the selected recipe is complete: The message "Please place item to be tared" is displayed and the [Skip] button  and [SAVE] button  are enabled.

- ❑ This is the screen for [Formulation mode]. This mode can be used only with the unit "g".
- ❑ Re-zero will be applied automatically when the screen changes to [Formulation mode].
- ❑ If the tare weight plus sample target value exceeds the capacity, the message "Overload error" is displayed for the item indicated by 5 in the figure above and the [SAVE] button  is disabled.

5.6.1. Selecting a recipe

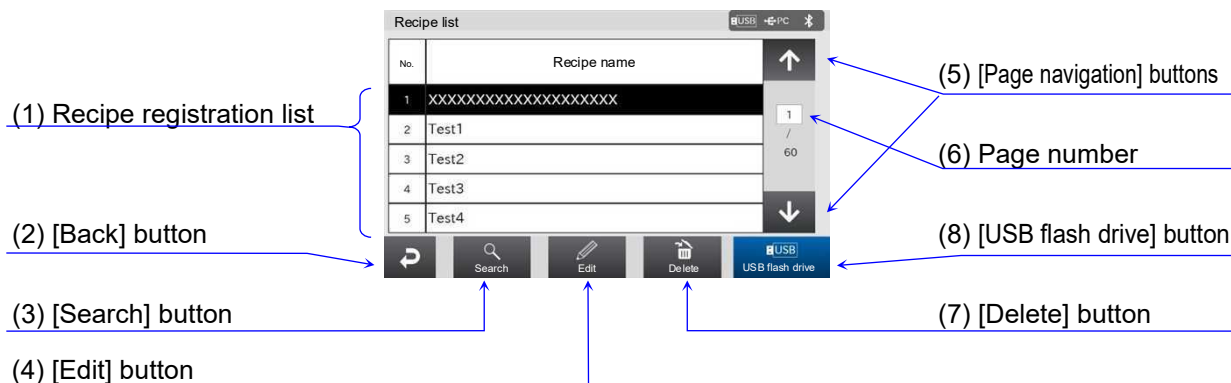

Display settings: [HOME] key  > [APP] button  > [Application] settings screen > [Application selection] button > Select [Formulation mode].
 [HOME] key  > [Formulation mode] screen > [Go to the recipe list] button > [Recipe list] screen.



	Name	Description
(1)	Recipe registration list	Displays the list of registered recipes. Touch a recipe to select. The selected recipe is highlighted in black.
(2)	[Back] button	Displays the [Formulation mode] screen (" 5.6. Formulation function ").
(3)	[Search] button	Displays the [Recipe search] screen (" 5.7.2. Searching a recipe ").
(4)	[Edit] button	Displays the [Recipe edit] screen (" 5.7.3. Editing a recipe ").
(5)	[Page navigation] buttons	Navigates to the previous/next recipe registration list page.
(6)	Page number	Displays the current page number. To display another page, touch this field and enter the page number.
(7)	[Delete] button	Deletes the selected recipe.
(8)	[USB flash drive] button	Displays the [Export/import recipe] screen (" 5.6.11. Exporting/importing recipes ").

- Up to 300 recipes can be registered in total.
- If you have many recipes registered and it is difficult to find one from the list, the recipe search function will come in useful.

5.6.2. Searching a recipe

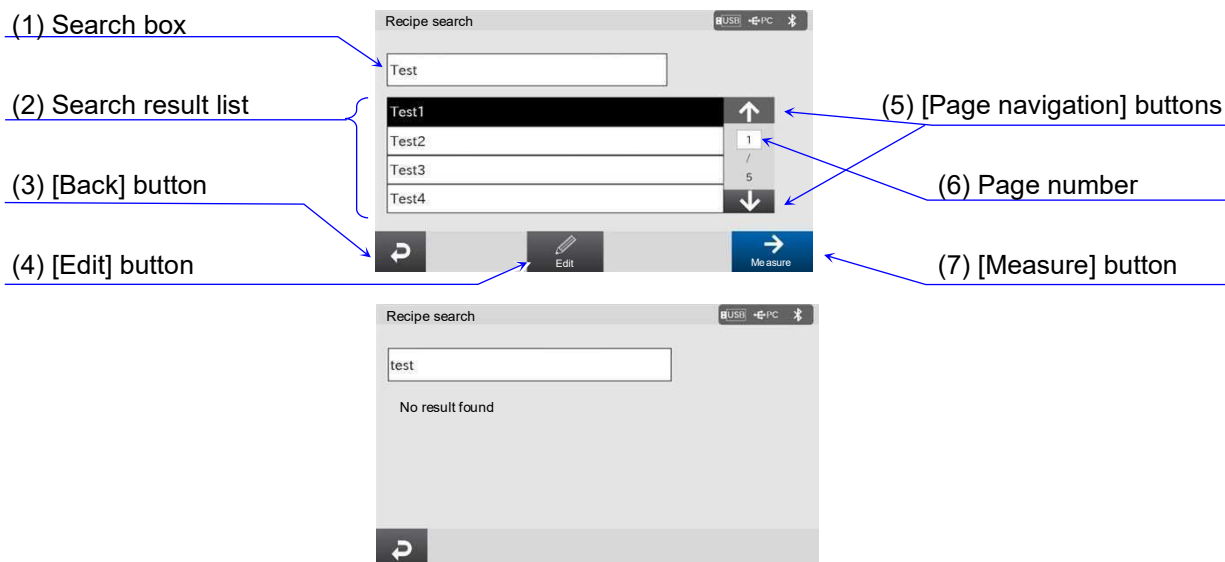

Display settings: [HOME] key  > [APP] button  > [Application] settings screen > [Application selection] button > Select [Formulation mode].
 [HOME] key  > [Formulation mode] screen > [Go to the recipe list] button > [Search] button > [Recipe search] screen.



	Name	Description
(1)	Search box	Enter the search term. The search method is prefix search. If there is no search result, the message "No result found" is displayed.
(2)	Search result list	Displays the list of search results. Touch a recipe to select. The selected recipe is highlighted in black.
(3)	[Back] button	Displays the [Recipe list] screen (" 5.6.1. Selecting a recipe ").
(4)	[Edit] button	Displays the [Recipe edit] screen (" 5.7.3. Editing a recipe "). Edit the contents of the selected recipe.
(5)	[Page navigation] buttons	Navigates to the previous/next search result page.
(6)	Page number	Displays the current page number. To display another page, touch this field and enter the page number.
(7)	[Measure] button	Displays the [Formulation mode] screen and starts measuring with the selected recipe (" 5.6. Formulation function ").

❑ The [Edit] button and [Measure] button only appear when the search results are displayed.

5.6.3. Editing a recipe

Display settings: [HOME] key  > [APP] button  > [Application] settings screen > [Application selection] button > Select [Formulation mode].

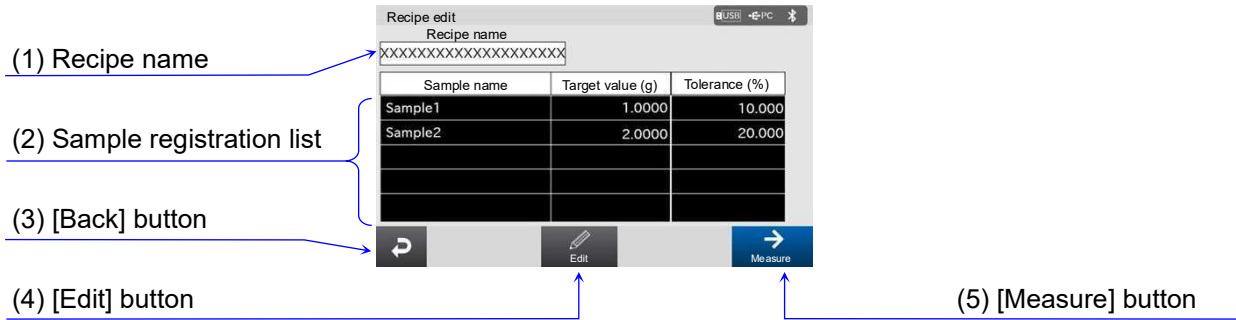

[HOME] key  > [Formulation mode] screen > [Go to the recipe list] button > Select a recipe > [Edit] button > [Recipe edit] screen.

- With the recipe to be edited selected on the [Recipe list] ("5.6.1. Selecting a recipe") or [Recipe search] screen ("5.7.2. Searching a recipe"), pressing the [Edit] button displays the [Recipe edit] screen.



	Name	Description
(1)	Recipe name	Enter the name of the recipe. Up to 20 characters can be used for the name.
(2)	Sample registration list	Displays the sample name, target value (g), and tolerance (%) registered in the recipe.
(3)	[Back] button	Displays the [Recipe list] screen ("5.6.1. Selecting a recipe").
(4)	[Edit] button	Displays the [Sample edit] screen ("5.6.4. Editing a sample"). On the [Sample edit] screen, register the sample information in the recipe.
(5)	[Measure] button	Displays the [Formulation mode] screen ("5.6. Formulation function").

5.6.4. Editing a sample

Display settings: [HOME] key  > [APP] button  > [Application] settings screen > [Application selection] button > Select [Formulation mode].
 [HOME] key  > [Formulation mode] screen > [Go to the recipe list] button > Select the recipe > [Edit] button > [Edit] button > [Sample edit] screen.

- ❑ Pressing the [Edit] button on the [Recipe edit] screen displays the [Sample edit] screen ("[5.6.3. Editing a recipe](#)").

(1)

[Selection] button in the [Sample name] field

(2) Target value

(3) Tolerance

(4) [Back] button

(5) [Add sample] button

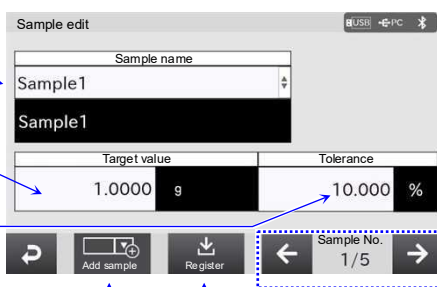

(6) Sample No.



(7) [Register] button

	Name	Setting value (setting range)	Description
(1)	[Selection] button in the [Sample name] field	—	Select the sample to be registered from the [Selection] button. Initially this field is blank. You can add samples on the [Sample registration] screen (" 5.6.5. Registering a sample "). Details are displayed below the [Selection] button.
(2)	Target value	Balance readability to weighing capacity	Set the target value to be weighed for the selected sample.
(3)	Tolerance	0.001 to 100.000	Set the tolerance for the target value to be weighed. Zero cannot be set for the tolerance.
(4)	[Back] button	—	Displays the [Recipe edit] screen (" 5.6.3. Editing a recipe "). The edited contents are discarded and the state before editing is restored.
(5)	[Add sample] button	—	Displays the [Sample registration] screen (" 5.6.5. Registering a sample ").
(6)	Sample No.	—	Displays the current sample number. Touching the left arrow button [←]/right arrow button [→] displays the previous/next page.
(7)	[Register] button	—	Registers the edited sample information. The [Recipe edit] screen will be displayed (" 5.6.3. Editing a recipe ").

- ❑ When a sample is selected in the [Sample name] field (1), the input fields for Target value (2) and Tolerance (3) are enabled.

- ❑ Pressing the [ON:OFF] key , [HOME] key , [LOG-IN] key , or [MENU] key  displays another screen, discards the edited contents, and restores to the state before editing.

5.6.5. Registering a sample



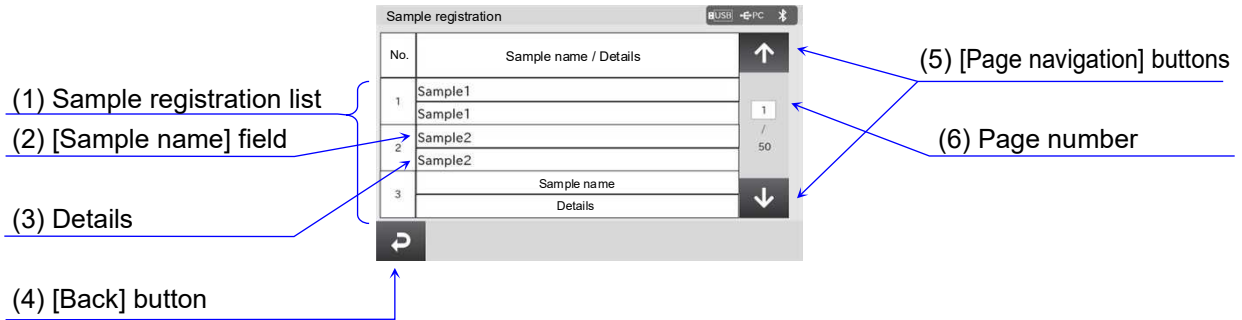

Display settings: [HOME] key  > [APP] button  > [Application] settings screen > [Application selection] button > Select [Formulation mode].
 [HOME] key  > [Formulation mode] screen > [Go to the recipe list] button > Select the recipe > [Edit] button > [Edit] button > [Add sample] button > [Sample registration] screen.

- Pressing the [Add sample] button on the [Sample edit] screen displays the [Sample registration] screen ("[5.6.4. Editing a sample](#)").







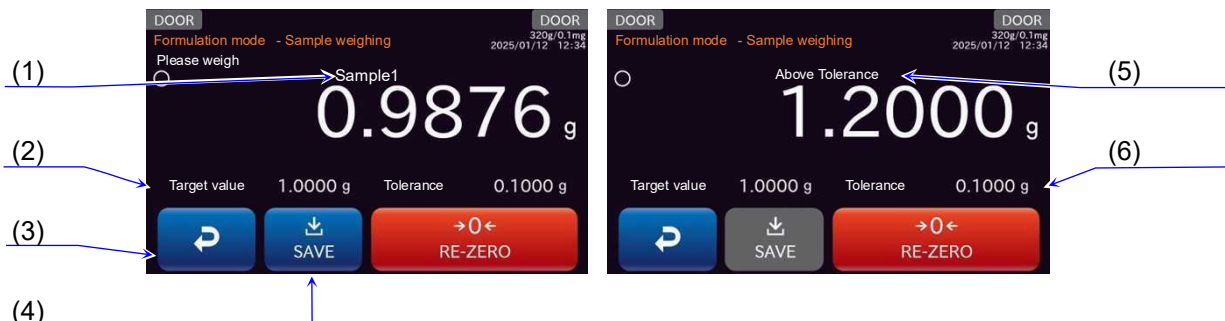

	Name	Description
(1)	Sample registration list	Displays a list of the registered samples. Up to 150 samples can be registered.
(2)	[Sample name] field	Enter the sample name to be displayed when you press the [Selection] button in the [Sample name] field on the [Sample edit] screen. Up to 20 characters can be entered (" 5.6.4. Editing a sample "). "Sample name" is displayed in a field where there is no entry.
(3)	Details	Enter the details that are displayed below the [Selection] button in the [Sample name] field on the [Sample edit] screen (" 5.6.4. Editing a sample "). Up to 30 characters can be entered. "Details" is displayed in a field where there is no entry.
(4)	[Back] button	Displays the [Sample edit] screen (" 5.6.4. Editing a sample ").
(5)	[Page navigation] buttons	Navigates to the previous/next sample registration list page.
(6)	Page number	Displays the current page number. To display another page, touch this field and enter the page number.

5.6.6. Sample weighing screen





Display settings: [HOME] key  > [APP] button  > [Application] settings screen > [Application selection] button > Select [Formulation mode].
 [HOME] key  > [Formulation mode] screen > [Skip] button  (or [SAVE] button ) > [Formulation mode - Sample weighing] screen.





	Name	Description
(1)	Sample name display	Displays the name of the sample to be weighed.
(2)	Target value display	Displays the target value of the registered sample.
(3)	[Back] button	Reweighs the tare of the sample currently being measured. <ul style="list-style-type: none"> <input type="checkbox"/> For the first sample, the [Formulation mode] screen will be displayed ("5.6. Formulation function"). <input type="checkbox"/> For samples other than the first, the tare weighing screen will be displayed ("5.6.7. Tare weighing screen").
(4)	[SAVE] button 	Records the weighing value of the desired sample. <ul style="list-style-type: none"> <input type="checkbox"/> Pressing the [SAVE] button  applies re-zeroing. <input type="checkbox"/> The [SAVE] button  is enabled when the weighing value stabilizes within the allowable range. Allowable range: $(Weighing\ value) - (Target\ value) \leq (Tolerance)$ <input type="checkbox"/> If the next sample is registered in the recipe, pressing the [SAVE] button  displays the [Formulation mode - Tare weighing] screen. <input type="checkbox"/> If it is the last sample, pressing the [SAVE] button  displays the [Formulation mode results] screen ("5.6.8. Measurement results screen").
(5)	Warning display for weighing value	Displayed with the stability indicator lit when the weighing value is stable while it is out of the allowable range. <ul style="list-style-type: none"> <input type="checkbox"/> If the weighing value exceeds the allowable range, the message [Above Tolerance] is displayed. <input type="checkbox"/> If the weighing value is below the allowable range, the message [Below Tolerance] is displayed.
(6)	Tolerance display	Displays the tolerance for the registered sample. The tolerance is registered as a ratio (%) to the target value and displayed as the value converted to the unit of measure (g).

To cancel the measurement, press the [HOME] key .

5.6.7. Tare weighing screen

Display settings: [HOME] key  > [APP] button  > [Application] settings screen > [Application selection] button → Select [Formulation mode].
 [HOME] key  > [Formulation mode] screen > [SAVE] button  > [Formulation mode - Tare weighing] screen.



	Name	Description
(1)	[SAVE] button 	Weighs the tare value and displays the [Formulation mode - Sample weighing] screen (" 5.6.6. Sample weighing screen "). If the recipe is incomplete, the [SAVE] button  is disabled. If the weighing value is negative, it is recorded as 0 g.
(2)	[Skip] button 	Skips tare weighing and displays the [Formulation mode - Sample weighing] screen (" 5.6.6. Sample weighing screen "). If the recipe is incomplete, the button is disabled.

- ❑ If the tare weight plus sample target value exceeds the capacity, the message "Overload error" is displayed for the item indicated by 3 in the figure above and the [SAVE] button  is disabled.

5.6.8. Measurement results screen

Display settings: [HOME] key > [APP] button > [Application] settings screen > [Application selection] button > Select [Formulation mode].

[HOME] key > [Formulation mode] screen > [Skip] button (or [SAVE] button) > [SAVE] button > [Formulation mode results] screen.

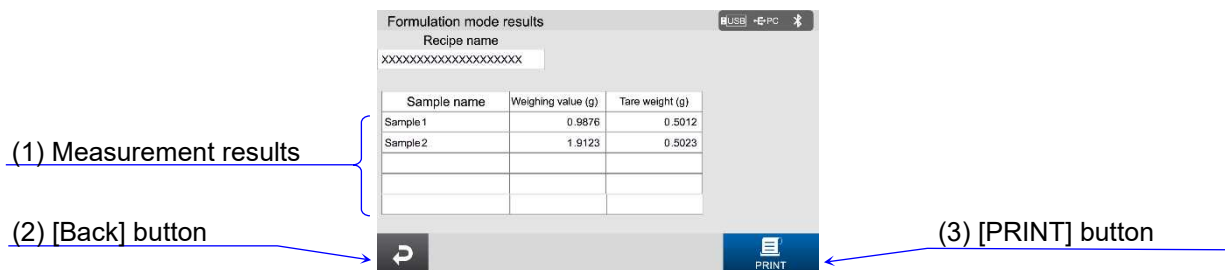

	Name	Description
(1)	Measurement results	Displays measurement results. If you press the [Skip] button for a sample, the tare weight field of the sample will be blank. If you press the [Skip] button for every sample, the tare weight column will not be displayed.
(2)	[Back] button	Displays the [Formulation mode] screen (" 5.6. Formulation function ").
(3)	[PRINT] button	Outputs the measurement results to a device connected to the balance.

Output example for formulation mode results

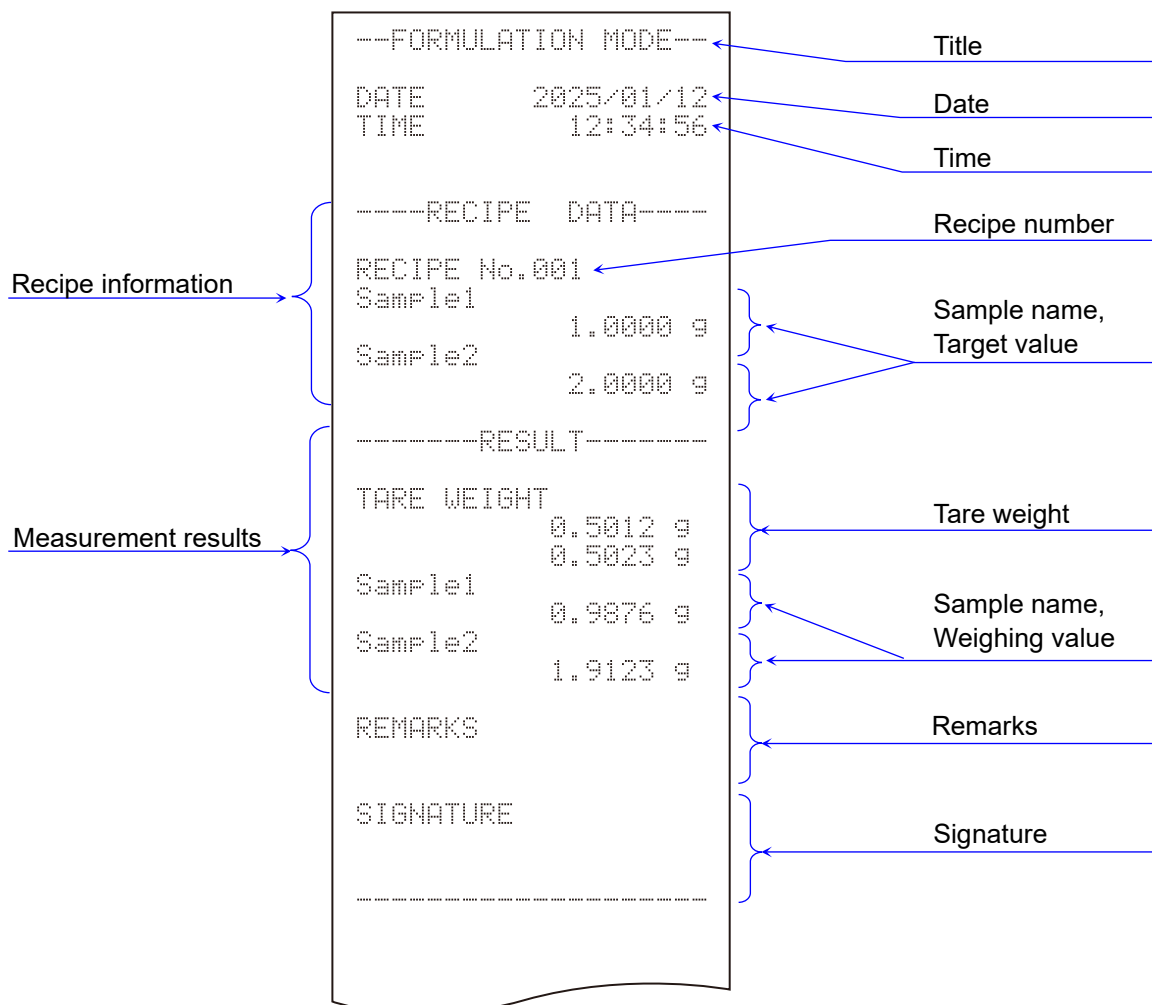



5.6.9. Recipe registration example





The following are used for this recipe registration example.

Recipe name: Test

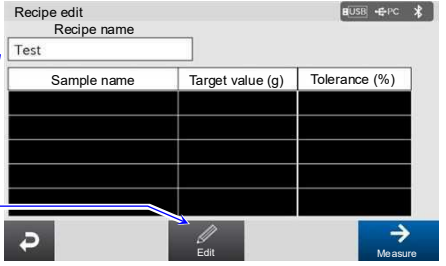
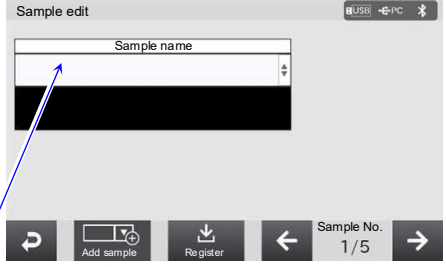
Samples to be registered:

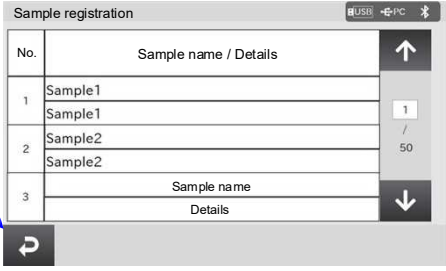
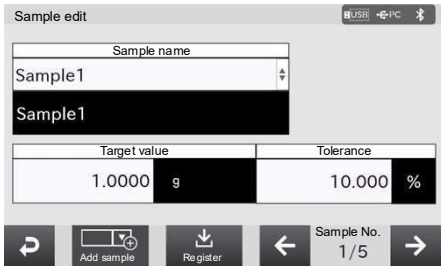
[Sample name] field	Details	Target value	Tolerance
Sample1	Sample 1	1.0000 g	10.000%
Sample2	Sample 2	1.0000 g	10.000%

Step	Description
1	<p>Press the [Go to the recipe list] button on the [Formulation mode] screen to display the [Recipe list] screen.</p> <p>Press the [Go to the recipe list] button</p> 
2	<p>On the [Recipe list] screen, touch and select the line with the number to which the recipe will be registered. In the example, the first line is selected for registration. After selecting the recipe to be registered, press the [Edit] button to display the [Recipe edit] screen in step 3.</p> <p>Press the [Edit] button</p> 
3	<p>Enter the recipe name. In the example, the recipe name is set to "Test". After inputting, press the [Edit] button to display the [Sample edit] screen in step 4.</p> <p>Enter the recipe name</p> <p>Press the [Edit] button</p> 
4	<p>Select the sample to be registered using the [Selection] button in the [Sample name] field. Initially, the [Sample name] field is blank. When using the formulation mode for the first time, add samples to the [Selection] button. To add a sample, press the [Add sample] button to display the [Sample registration] screen in step 5. If you have samples already registered, proceed to step 6.</p> <p>[Selection] button in the [Sample name] field</p> <p>Press the [Add sample] button</p> 

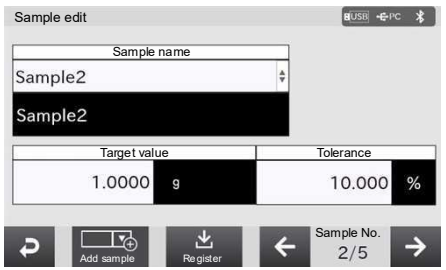
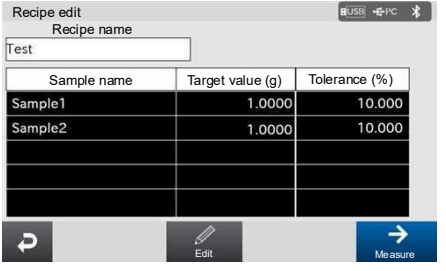
Step	Description
5	<p>Enter the [Sample name] and [Details] to be registered. The figure on the right shows an input example on the [Sample registration] screen. After inputting, press the [Back] button to display the [Sample edit] screen.</p> <p style="text-align: center;">Enter the fields then press the [Back] button</p> 
6	<p>Register the first sample in the recipe. Select the desired sample from the [Selection] button. After selection, enter the values for the [Target value] and [Tolerance] fields. In the example, the sample name is Sample1, the target value is 1.0000 g, and the tolerance is 10.000%. After inputting, press the right arrow button [→] at the bottom right of the screen to display the registration screen for the second sample.</p> <p style="text-align: center;">The right arrow button [→] displays the registration screen for the next sample.</p> 
7	<p>Register the second sample in the recipe. Enter values in the [Target value] and [Tolerance] fields. Then, press the [Register] button to register the recipe and display the [Recipe edit] screen. In the example, the sample name is Sample2, the target value is 1.0000 g, and the tolerance is 10.000%.</p> <p style="text-align: center;">Press the [Register] button</p> <p>CAUTION</p> <p>❑ If the [Back] button, [ON:OFF] key , [HOME] key , [LOG-IN] key , or [MENU] key  is pressed to display another screen, the sample is not registered in the recipe.</p> 
8	<p>Now the recipe registration is complete. To start measurement with the registered recipe, press the [Measure] button on the [Recipe edit] screen.</p> <p>To register another recipe, press the [Back] button on the [Recipe edit] screen to display the [Recipe list] screen, and then repeat from step 2 to register the recipe.</p> 





5.6.10. Measurement example

Select a recipe to perform measurement according to the recipe. The registration example below is described here as an example.

Recipe name: Test



Samples to be registered:

[Sample name] field	Details	Target value	Tolerance
Sample1	Sample 1	1.0000 g	10.000%
Sample2	Sample 2	1.0000 g	10.000%

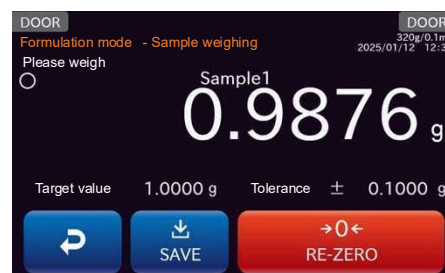
Step	Description
1	<p>Press the [Go to the recipe list] button on the [Formulation mode] screen to display the [Recipe list] screen.</p> <p>Select the recipe to be used for the measurement from the list and press the [Back] button to display the [Formulation mode] screen.</p> <p>Re-zero will be applied automatically when the screen changes to the [Formulation mode] screen. Sample1 is selected here as an example.</p>
2	<p>To record the tare value:</p> <p>Press the [SAVE] button  when the weighing value is 0 g or greater and stable. Tare operation will be applied automatically when the [SAVE] button  is pressed. The weighing screen for the first sample is displayed.</p> <p>If the target value plus tare value of the first sample exceeds the capacity, the [SAVE] button  is disabled.</p> <p>To skip recording of the tare value:</p> <p>Press the [Skip] button . The weighing screen for the first sample is displayed.</p> <p>If a warning is displayed at the top of the screen:</p> <p>Check the recipe name or the target value and tolerance value of the registered sample.</p>
3	<p>Weigh the displayed sample.</p> <p>When the stability indicator lights up and the [SAVE] button  is enabled, press the button to save the weighing value.</p> <p>Allowable range: $(Weighing\ value) - (Target\ value) \leq (Tolerance)$</p> <p>If the allowable range is exceeded:</p> <p>To start over from tare weighing with the current sample, press the [Back] button.</p>
4	<p>Repeat the tare weighing and sample weighing in steps 2 and 3 for every sample registered in the recipe.</p>
5	<p>The measurement results screen will be displayed when measurement of all samples is completed. Check and output the results. Then, press the [Back] button to display the [Formulation mode] screen.</p>



5.6.11. Exporting/importing recipes

Display settings: [HOME] key  > [Formulation mode] screen > [Go to the recipe list] button > [USB flash drive] button  > [Export/import recipe] screen.

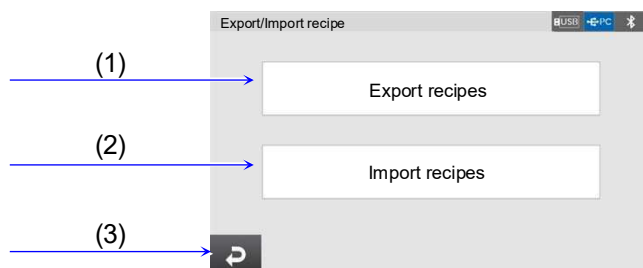

	Name	Description
(1)	[Export recipes] button	Exports recipes that are registered in the USB flash drive.
(2)	[Import recipes] button	Imports recipes from the USB flash drive.
(3)	[Back] button	Returns to the previous screen.

- The name of the exported file is 'ExportedRecipe_Formulation.'
- When recipes are imported, an error message will be displayed if there is no file mentioned above in the USB flash drive or the contents of the file are wrong.
- Recipes cannot be imported to models that have a different weighing capacity.

5.7. HPLC function

HPLC function usage

- ❑ The HPLC function allows you to register in the recipe the sample to be weighed and the molarity (mol/L, mmol/L) or the target value in unit of mass (g) and the tolerance for the target value, and to perform weighing according to the recipe.

- ❑ The target value (g) of the sample is calculated by the following formula.

Target value (g) = Molarity (mol/L) x Solution volume (L) x Molecular weight

CAUTION

- ❑ Initializing the balance clears the sample contents and registered recipes (excluding those registered at the time of shipment from the factory).







- ❑ If you configure this display, the [HOME] screen changes to HPLC mode.

Display settings: [HOME] key  > [APP] button  > [Application] settings screen >

[Application selection] button > Select [HPLC mode].



[HOME] key  > [HPLC mode] screen.



	Name	Description
(1)	HPLC mode	Displayed when in the HPLC mode.
(2)	[Go to the recipe list] button	Displays the [Recipe list] (" 5.7.1. Selecting a recipe "). The name of the currently selected recipe is displayed here.
(3)	[Skip] button 	Skips tare weighing and displays the [HPLC mode - Sample weighing] screen (" 5.7.6. Sample weighing screen "). If the recipe is incomplete, the button is disabled.
(4)	[SAVE] button 	Weighs the tare value and displays the [HPLC mode - Sample weighing] screen (" 5.7.6. Sample weighing screen "). If the recipe is incomplete, the [SAVE] button  is disabled. If the weighing value is negative, it is recorded as 0 g.
(5)	Display indicating that the recipe is incomplete	If the selected recipe is incomplete: The message "The recipe is incomplete. Please check the recipe details." is displayed and the [Skip] button  and [SAVE] button  are disabled. Check the recipe name and the target value and tolerance of the sample registered in the recipe. If the selected recipe is complete: The message "Please place item to be tared" is displayed and the [Skip] button  and [SAVE] button  are enabled.

- ❑ This is the screen for [HPLC mode]. This mode can be used only with the unit "g".
- ❑ Re-zero will be applied automatically when the screen changes to [HPLC mode].
- ❑ If the tare weight plus sample target value exceeds the capacity, the message "Overload error" is displayed for the item indicated by 5 in the figure above and the [SAVE] button  is disabled.

5.7.1. Selecting a recipe

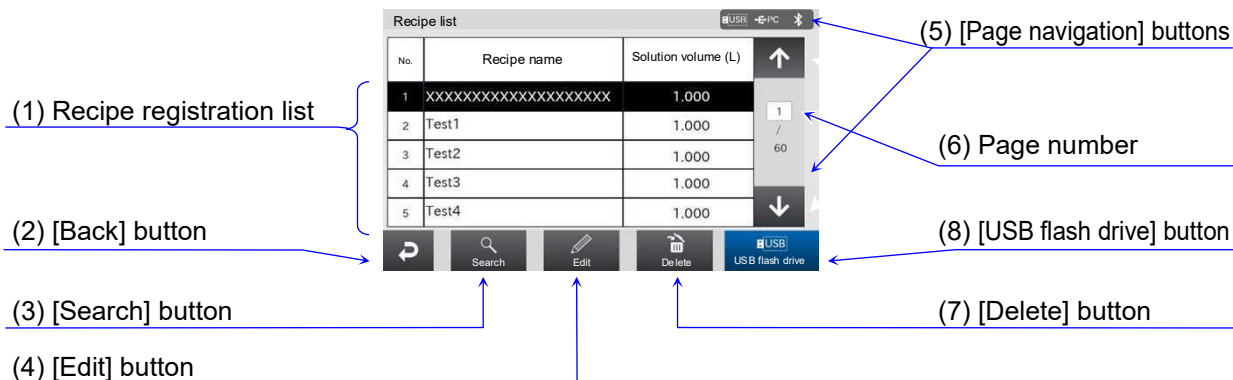

Display settings: [HOME] key  > [APP] button  > [Application] settings screen > [Application selection] button > Select [HPLC mode].
 [HOME] key  > [HPLC mode] screen > [Go to the recipe list] button > [Recipe list] screen.



	Name	Description
(1)	Recipe registration list	Displays the list of registered recipes. Touch a recipe to select. The selected recipe is highlighted in black.
(2)	[Back] button	Displays the [HPLC mode] screen (" 5.7. HPLC function ").
(3)	[Search] button	Displays the [Recipe search] screen (" 5.7.2. Searching a recipe ").
(4)	[Edit] button	Displays the [Recipe edit] screen (" 5.7.3. Editing a recipe ").
(5)	[Page navigation] buttons	Navigates to the previous/next recipe registration list page.
(6)	Page number	Displays the current page number. To display another page, touch this field and enter the page number.
(7)	[Delete] button	Deletes the selected recipe.
(8)	[USB flash drive] button	Displays the [Export/import recipe] screen (" 5.7.11. Exporting/importing recipes ").

- Up to 300 recipes can be registered in total.
- If you have many recipes registered and it is difficult to find one from the list, the recipe search function will come in useful.

5.7.2. Searching a recipe

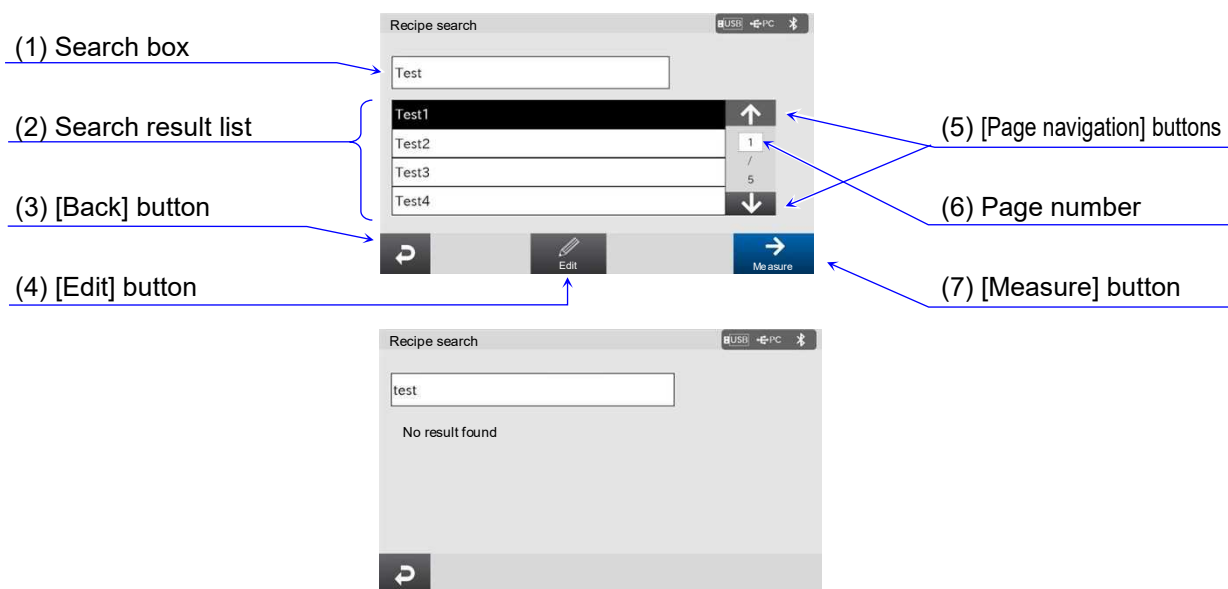

Display settings: [HOME] key  > [APP] button  > [Application] settings screen > [Application selection] button > Select [HPLC mode].
 [HOME] key  > [HPLC mode] screen > [Go to the recipe list] button > [Search] button > [Recipe search] screen.



	Name	Description
(1)	Search box	Enter the search term. The search method is prefix search. If there is no search result, the message "No result found" is displayed.
(2)	Search result list	Displays the list of search results. Touch a recipe to select. The selected recipe is highlighted in black.
(3)	[Back] button	Displays the [Recipe list] screen (" 5.7.1. Selecting a recipe ").
(4)	[Edit] button	Displays the [Recipe edit] screen (" 5.6.3. Editing a recipe "). Edit the contents of the selected recipe.
(5)	[Page navigation] buttons	Navigates to the previous/next search result page.
(6)	Page number	Displays the current page number. To display another page, touch this field and enter the page number.
(7)	[Measure] button	Displays the [HPLC mode] screen and starts measuring with the selected recipe (" 5.7. HPLC function ").

❑ The [Edit] button and [Measure] button only appear when the search results are displayed.

5.7.3. Editing a recipe

Display settings: [HOME] key  > [APP] button  > [Application] settings screen > [Application selection] button > Select [HPLC mode].

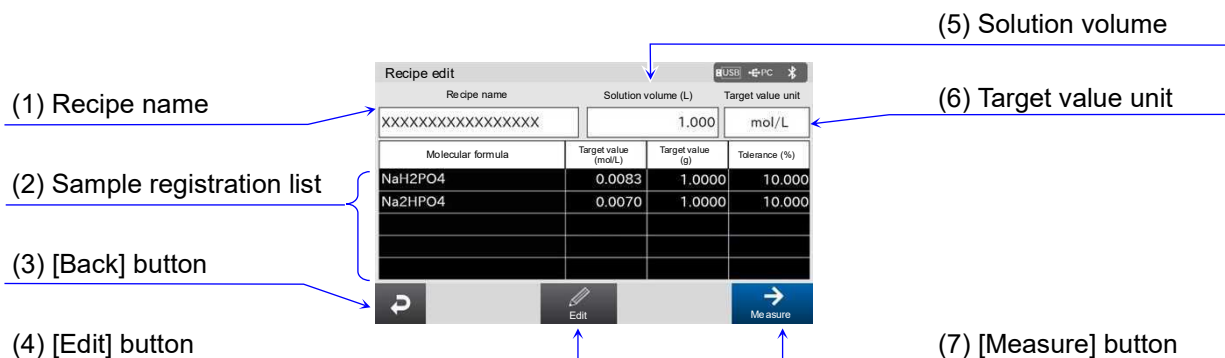

[HOME] key  > [HPLC mode] screen > [Go to the recipe list] button > Select a recipe > [Edit] button > [Recipe edit] screen.

- With the recipe to be edited selected on the [Recipe list] or [Recipe search] screen, pressing the [Edit] button displays the [Recipe edit] screen.



	Name	Description
(1)	Recipe name	Enter the name of the recipe. Up to 20 characters can be used for the name.
(2)	Sample registration list	Displays the molecular formula, target molarity (mol/L or mmol/L), target value (g), and tolerance (%) registered in the recipe.
(3)	[Back] button	Displays the [Recipe list] screen (" 5.7.1. Selecting a recipe ").
(4)	[Edit] button	Displays the [Sample edit] screen (" 5.7.4. Editing a sample "). On the [Sample edit] screen, register the sample information in the recipe.
(5)	Solution volume	Enter the volume of the solution to make.
(6)	Target value unit	Set the unit of the target value to be entered on the [Sample edit] screen (" 5.7.4. Editing a sample "). The unit can be selected from mol/L, mmol/L, and g.
(7)	[Measure] button	Displays the [HPLC mode] screen (" 5.7. HPLC function ").

5.7.4. Editing a sample

Display settings: [HOME] key  > [APP] button  > [Application] settings screen > [Application selection] button > Select [HPLC mode].

[HOME] key  > [HPLC mode] screen > [Go to the recipe list] button > Select the recipe > [Edit] button > [Edit] button > [Sample edit] screen.

- Pressing the [Edit] button on the [Recipe edit] screen displays the [Sample edit] screen ("5.7.3. Editing a recipe").

(1)

[Molecular formula] field, [Selection] button

(2) Target value

(3) [Back] button

(4) [Add sample] button

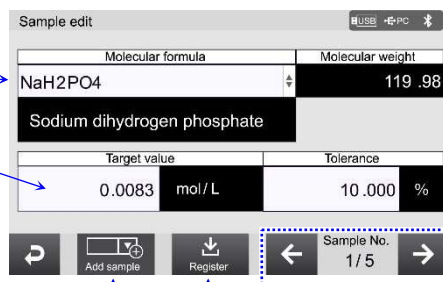

(5) Tolerance

(6) Sample No.

(7) [Register] button



	Name	Setting value (setting range)	Description
(1)	[Molecular formula] field, [Selection] button	—	Select the sample to be registered from the [Selection] button. Initially this field is blank. You can add samples on the [Sample registration] screen ("5.7.5. Registering a sample"). Sample names are displayed below the [Selection] button.
(2)	Target value	Balance readability to capacity	Set the target value to be weighed for the selected sample.
(3)	[Back] button	—	Displays the [Recipe edit] screen ("5.7.3. Editing a recipe"). The edited contents are discarded and the state before editing is restored.
(4)	[Add sample] button	—	Displays the [Sample registration] screen ("5.7.5. Registering a sample").
(5)	Tolerance	0.001 to 100.000	Set the tolerance for the target value to be weighed. Zero cannot be set for the tolerance.
(6)	Sample No.	—	Displays the current sample number. Touching the left arrow button [←]/right arrow button [→] displays the previous/next page.
(7)	[Register] button	—	Registers the edited sample information. The [Recipe edit] screen will be displayed ("5.7.3. Editing a recipe").

- When a sample is selected in the [Sample name] field (1), the input fields for Target value (2) and Tolerance (5) are enabled.

- The following samples are registered for the [Selection] button at the time of shipment from the factory.

Display in the [Molecular formula] field	Sample name	Molecular weight
NaH ₂ PO ₄	Sodium dihydrogen phosphate	119.98
Na ₂ HPO ₄	Disodium hydrogen phosphate	141.96
KH ₂ PO ₄	Potassium dihydrogen phosphate	136.09
K ₂ HPO ₄	Dipotassium hydrogen phosphate	174.18
C ₆ H ₈ O ₇ ·H ₂ O	Citric acid hydrate	210.14
C ₆ H ₅ Na ₃ O ₇ ·2H ₂ O	Trisodium citrate dihydrate	294.10
CH ₃ COONa	Sodium acetate	82.03
CH ₃ COONH ₄	Ammonium acetate	77.08
HCOONH ₄	Ammonium formate	63.06
C ₄ H ₄ Na ₂ O ₆ ·2H ₂ O	Sodium tartrate dihydrate	230.08
H ₃ BO ₃	Boric acid	61.83
NaClO ₄	Sodium perchlorate	122.44
NaCl	Sodium chloride	58.44

5.7.5. Registering a sample

Display settings: [HOME] key  > [APP] button  > [Application] settings screen > [Application selection] button > Select [HPLC mode].
 [HOME] key  > [HPLC mode] screen > [Go to the recipe list] button > Select the recipe > [Edit] button > [Edit] button > [Add sample] button > [Sample registration] screen.

- Pressing the [Add sample] button on the [Sample edit] screen displays the [Sample registration] screen ("[5.7.4. Editing a sample](#)").

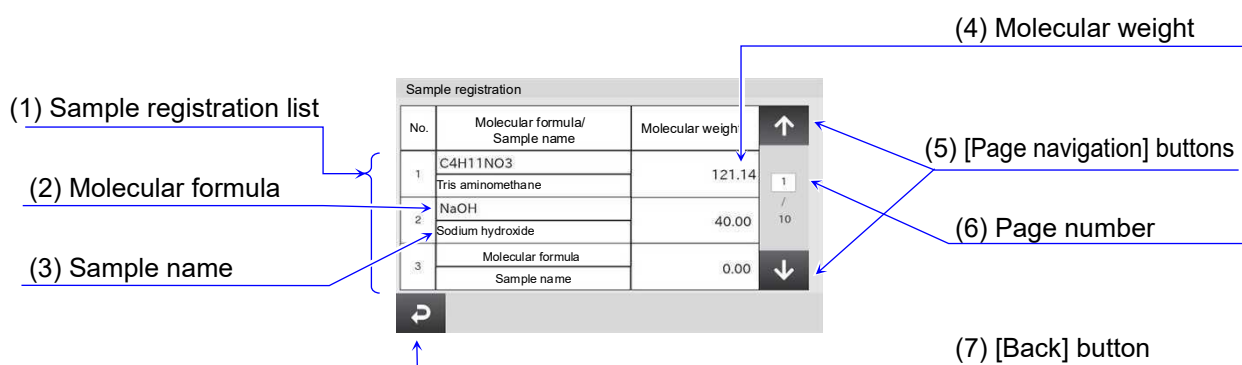

	Name	Description
(1)	Sample registration list	Displays a list of the registered samples. In addition to the 13 samples initially registered, 30 samples can be registered.
(2)	Molecular formula	Enter the sample name to be displayed when you press the [Selection] button in the [Molecular formula] field on the [Sample edit] screen (" 5.7.4. Editing a sample "). Up to 20 characters can be entered. "Molecular formula" is displayed in the field where there is no entry.
(3)	Sample name	Enter the sample name to be displayed below the [Selection] button in the [Sample name] field on the [Sample edit] screen (" 5.7.4. Editing a sample "). Up to 30 characters can be entered. "Sample name" is displayed in a field where there is no entry.
(4)	Molecular weight	Enter the molecular weight of the sample to be registered.*1
(5)	[Page navigation] buttons	Navigates to the previous/next sample registration list page.
(6)	Page number	Displays the current page number. To display another page, touch this field and enter the page number.
(7)	[Back] button	Displays the [Sample edit] screen (" 5.7.4. Editing a sample ").





*1 When the sample is not registered in the recipe:

The input range for the molecular weight of the sample is 0.00 to 9999999.99.





When the sample is already registered in the recipe:

The molecular weight can be entered in the range in which the amount to be weighed does not exceed the capacity of the balance.

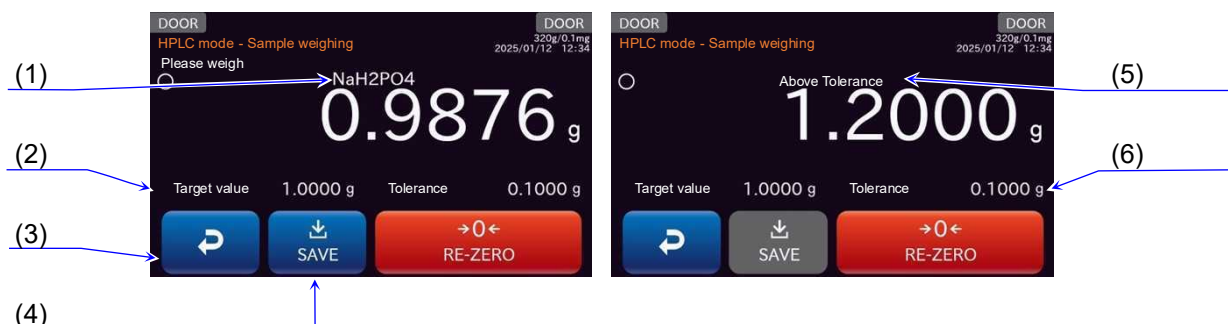
5.7.6. Sample weighing screen

Display settings: [HOME] key  > [APP] button  > [Application] settings screen
 [Application selection] button > Select [HPLC mode].
 [HOME] key  > [HPLC mode] screen > [Skip] button  (or [SAVE] button ) > [HPLC mode - Sample weighing] screen.



	Name	Description
(1)	Sample name display	Displays the name of the sample to be weighed.
(2)	Target value display	Displays the target value of the registered sample.
(3)	[Back] button	Reweighs the tare of the sample currently being measured. <ul style="list-style-type: none"> <input type="checkbox"/> For the first sample, the [HPLC mode] screen will be displayed ("5.7. HPLC function"). <input type="checkbox"/> For samples other than the first, the [HPLC mode - Tare weighing] screen will be displayed ("5.7.7. Tare weighing screen").
(4)	[SAVE] button 	Records the weighing value of the desired sample. <ul style="list-style-type: none"> <input type="checkbox"/> Pressing the [SAVE] button  applies re-zeroing. <input type="checkbox"/> The [SAVE] button  is enabled when the weighing value stabilizes within the allowable range. Allowable range: $(Weighing\ value) - (Target\ value) \leq (Tolerance)$ <input type="checkbox"/> If the next sample is registered in the recipe, pressing the [SAVE] button  displays the [HPLC mode - Tare weighing] screen ("5.7.7. Tare weighing screen"). <input type="checkbox"/> If it is the last sample, pressing the [SAVE] button  displays the [HPLC mode results] screen ("5.7.8. Measurement results screen").
(5)	Warning display for weighing value	Displayed with the stability indicator lit when the weighing value is stable while it is out of the allowable range. <ul style="list-style-type: none"> <input type="checkbox"/> If the weighing value exceeds the allowable range, the message [Above tolerance] is displayed. <input type="checkbox"/> If the weighing value is below the allowable range, the message [Below Tolerance] is displayed.
(6)	Tolerance display	Displays the tolerance for the registered sample. The tolerance is registered as a ratio (%) to the target value and displayed as the value converted to the unit of measure (g).

To cancel the measurement, press the [HOME] key .

5.7.7. Tare weighing screen

Display settings: [HOME] key > [APP] button > [Application] settings screen > [Application selection] button > Select [HPLC mode].
 [HOME] key > [HPLC mode] screen > [SAVE] button > [HPLC mode - Tare weighing] screen.



	Name	Description
(1)	[SAVE] button	Weighs the tare value and displays the [HPLC mode - Sample weighing] screen (" 5.6.6. Sample weighing screen "). If the recipe is incomplete, the [SAVE] button is disabled. If the weighing value is negative, it is recorded as 0 g.
(2)	[Skip] button	Skips tare weighing and displays the [HPLC mode - Sample weighing] screen (" 5.6.6. Sample weighing screen "). If the recipe is incomplete, the button is disabled.

❑ If the tare weight plus sample target value exceeds the capacity, the message "Overload error" is displayed for the item indicated by 3 in the figure above and the [SAVE] button is disabled.

5.7.8. Measurement results screen

Display settings: [HOME] key > [APP] button > [Application] settings screen > [Application selection] button > Select [HPLC mode].
 [HOME] key > [HPLC mode] screen > [Skip] button (or [SAVE] button) > [SAVE] button > [HPLC mode results] screen.

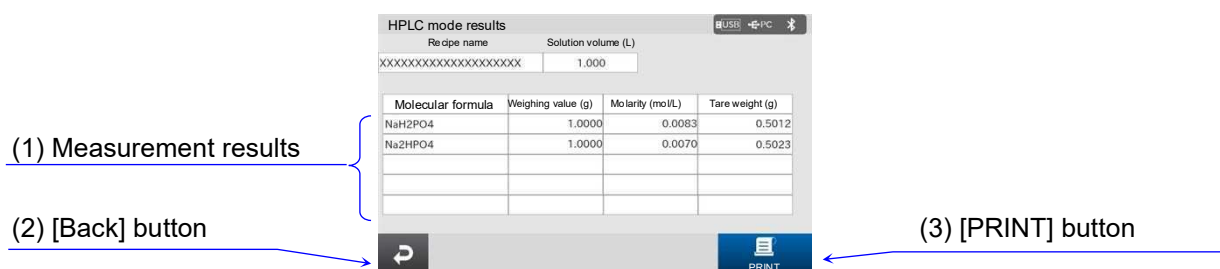

	Name	Description
(1)	Measurement results	Displays measurement results. If you press the [Skip] button for a sample, the tare weight field of the sample will be blank. If you press the [Skip] button for every sample, the tare weight column will not be displayed.
(2)	[Back] button	Displays the [HPLC mode] screen (" 5.7. HPLC function ").
(3)	[PRINT] button	Outputs the measurement results to a device connected to the balance.

Output example for HPLC mode results

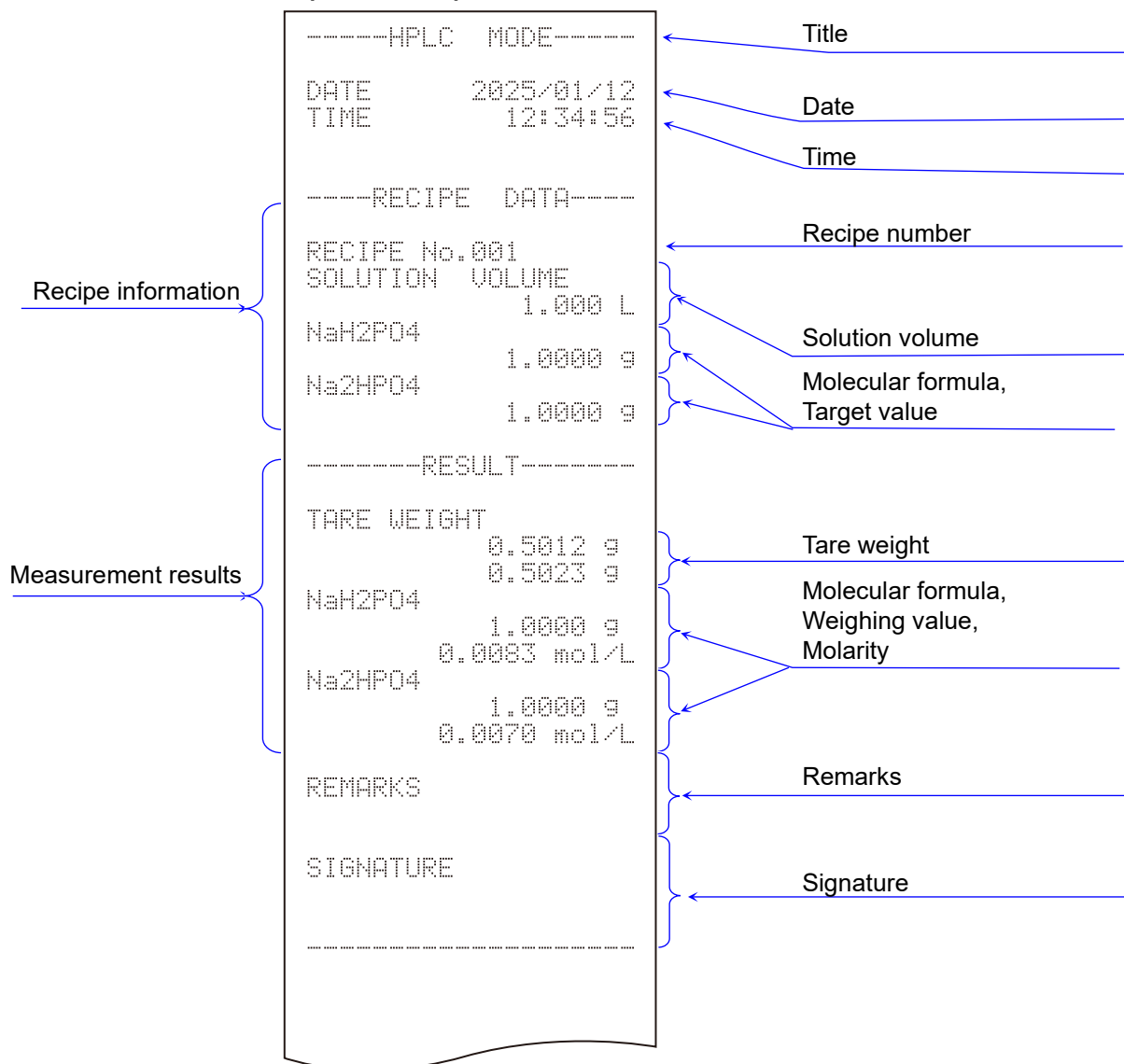

5.7.9. Recipe registration example



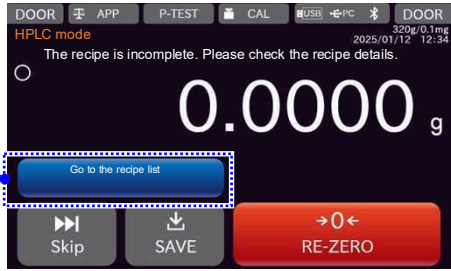
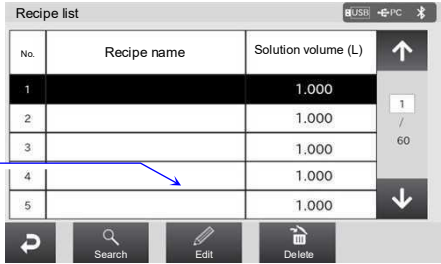
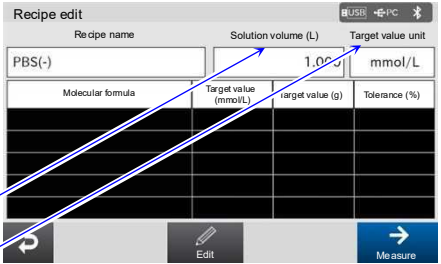

The following are used for this recipe registration example.

Recipe name	PBS(-)
Target value unit	mmol/L
Solution volume	1 L

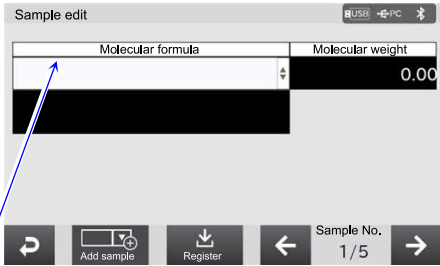
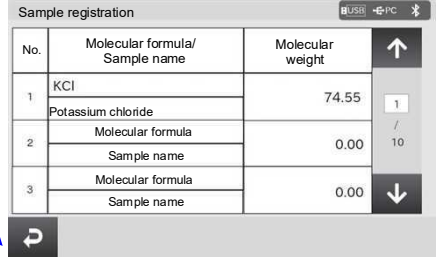
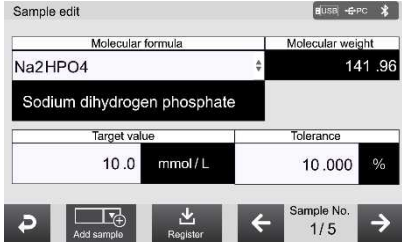
Sample name	Target value	Tolerance
Disodium hydrogen phosphate	10.0 mmol/L	10.000%
Potassium dihydrogen phosphate	2.0 mmol/L	10.000%
Sodium chloride	137.0 mmol/L	10.000%
Potassium chloride	2.7 mmol/L	10.000%

Step	Description
1	<p>On the [HPLC mode] screen, press the [Go to the recipe list] button to display the [Recipe list] screen.</p> <p>Press the [Go to the recipe list] button</p> 
2	<p>On the [Recipe list] screen, touch and select the line with the number to which the recipe will be registered. In the example, the first line is selected for registration. After selecting the recipe to be registered, press the [Edit] button to display the [Recipe edit] screen in step 3.</p> <p>Press the [Edit] button</p> 
3	<p>Enter the recipe name. In the example, the recipe name is set to "PBS (-)", the buffer volume is set to 1.000 L, and the target value unit is set to mmol/L. After setting, press the [Edit] button to display the [Sample edit] screen in step 4.</p> <p>Enter the recipe name</p> <p>Enter the solution volume</p> <p>Specify the target value unit</p> <p>Press the [Edit] button</p> 

Step	Description
4	<p>Select the sample to be registered using the [Selection] button in the [Molecular formula] field. To select a sample other than the one registered at the time of shipment from the factory, the sample needs to be added to the [Selection] button. In this case, press the [Add sample] button to go to the [Sample registration] screen in step 5. In this example, potassium chloride is newly registered. Press the [Add sample] button to go to step 5. If a sample does not need to be added, proceed to step 6.</p> <p>[Selection] button in the [Molecular formula] field</p> <p>Press the [Add sample] button</p> 
5	<p>Enter the [Molecular formula] and [Sample name] to be registered. The figure on the right shows an input example on the [Sample registration] screen. After inputting, press the [Back] button to display the [Sample edit] screen.</p> <p>Enter the fields then press the [Back] button</p> 
6	<p>Register the first sample in the recipe. Select the desired sample from the [Selection] button. After selection, enter the values for the [Target value] and [Tolerance] fields. In the example, the sample name is Na₂HPO₄, the target value is 10.0 mmol/L, and the tolerance is 10.000 %. After inputting, press the right arrow button [→] at the bottom right of the screen to display the registration screen for the second sample.</p> <p>The right arrow button [→] displays the registration screen for the next sample.</p> 

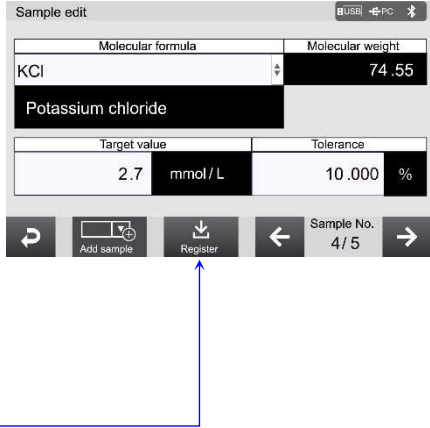
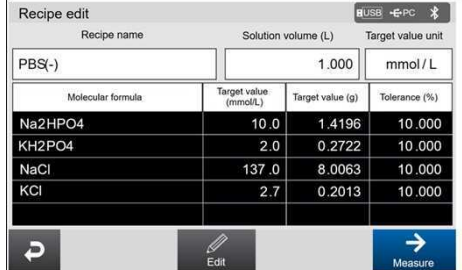





Step	Description
7	<p>Enter the contents of the remaining samples in the same way.</p> <p>Then, press the [Register] button to register the recipe and display the [Recipe edit] screen.</p> <p>CAUTION</p> <p>❑ If the [Back] button, [ON:OFF] key , [HOME] key , [LOG-IN] key , or [MENU] key  is pressed to display another screen, the sample is not registered in the recipe.</p> <p style="text-align: center;"><u>Press the [Register] button</u></p> 
8	<p>Now the recipe registration is complete.</p> <p>To start measurement with the registered recipe, press the [Measure] button on the [Recipe edit] screen.</p> <p>To register another recipe, press the [Back] button on the [Recipe edit] screen to display the [Recipe list] screen, and then register the recipe on the [Recipe list] screen shown in step 2.</p> 

5.7.10. Measurement example



Select a recipe to perform measurement according to the recipe. The registration example below is described here as an example.

Recipe name	PBS(-)
Target value unit	mmol/L
Solution volume	1 L

Sample name	Target value	Tolerance
Disodium hydrogen phosphate	10.0 mmol/L	10.000%
Potassium dihydrogen phosphate	2.0 mmol/L	10.000%
Sodium chloride	137.0 mmol/L	10.000%
Potassium chloride	2.7 mmol/L	10.000%

Step	Description
1	<p>On the [HPLC mode] screen, press the [Go to the recipe list] button to display the [Recipe list] screen.</p> <p>Select the recipe to be used for the measurement from the list and press the [Back] button to display the [HPLC mode] screen.</p> <p>Re-zero will be applied automatically when the screen changes to the [HPLC mode] screen.</p> <p>Sample 1 is selected here as an example.</p>
2	<p>To record the tare value:</p> <p>Press the [SAVE] button  when the weighing value is 0 g or greater and stable.</p> <p>Tare operation will be applied automatically when the [SAVE] button  is pressed.</p> <p>The weighing screen for the first sample is displayed.</p> <p>If the target value plus tare value of the first sample exceeds the capacity, the [SAVE] button  is disabled.</p> <p>To skip recording of the tare value:</p> <p>Press the [Skip] button .</p> <p>The weighing screen for the first sample is displayed.</p> <p>If a warning is displayed at the top of the screen:</p> <p>Check the recipe name or the target value and tolerance value of the registered sample.</p>
3	<p>Weigh the displayed sample.</p> <p>When the stability indicator lights up and the [SAVE] button  is enabled, press the button to save the weighing value.</p> <p>Allowable range: $(Weighing\ value) - (Target\ value) \leq (Tolerance)$</p> <p>If the allowable range is exceeded:</p> <p>To start over from tare weighing with the current sample, press the [Back] button.</p>
	
4	Repeat the tare weighing and sample weighing in steps 2 and 3 for every sample registered in the recipe.
5	The measurement results screen will be displayed when measurement of all samples is completed. Check and output the results. Then, press the [Back] button to display the [HPLC mode] screen.

5.7.11. Exporting/importing recipes

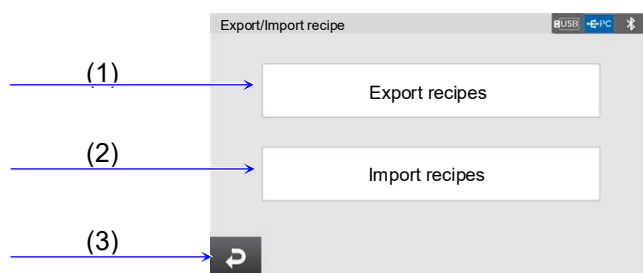

Display settings: [HOME] key  > [HPLC mode] screen > [Go to the recipe list] button > [USB flash drive] button  > [Export/import recipe] screen.



	Name	Description
(1)	[Export recipes] button	Exports recipes that are registered in the USB flash drive.
(2)	[Import recipes] button	Imports recipes from the USB flash drive.
(3)	[Back] button	Returns to the previous screen.

- The name of the exported file is 'ExportedRecipe_HPLC.'
- When recipes are imported, an error message will be displayed if there is no file mentioned above in the USB flash drive or the contents of the file is wrong.
- Recipes cannot be imported to models that have a different weighing capacity.

5.8. Density (specific gravity) measurement function

- If you configure this display, the [HOME] screen changes to the Density measurement mode.
 Display settings: [HOME] key  > [APP] button  > [Application] settings screen > [Application selection] button > Select [Density measurement mode].
 [HOME] key  > [Density measurement mode] screen.



	Name	Description
(1)	Density measurement mode	Displayed in the Density measurement mode.
(2)	[Settings] button	Displays the [Measurement conditions] screen (" 5.8.1. Measurement conditions ").
(3)	[Confirm] button	Confirms the current input setting and proceeds to the next instruction.

- This is the screen for [Density measurement mode]. This mode is only available with the unit "g" and 0.0001 g readability.

Density measurement function usage

- The density measurement function calculates the density of a solid by using its weight in air and its weight in liquid.
- We recommend using the AD-1653 Density Determination Kit (sold separately) for measurements. For assembly and installation instructions, refer to the [AD-1653 Instruction Manual](#).

Density formula

Density of a solid

The density of a solid can be determined from the weight of the sample in air, the weight of the sample in liquid, and the density of the liquid.

$$\rho = \frac{A}{A-B} \times \rho_0$$

ρ : Density of sample A : Weight of sample in air
 ρ_0 : Density of liquid B : Weight of sample in liquid



Density of a liquid

Using a sinker with a known volume, the density of a liquid can be determined from the weight of the sinker in air, the weight of the sinker in liquid, and the volume of the sinker.

$$\rho = \frac{A-B}{V}$$

ρ : Density of sample A : Weight of sinker in air
 V : Volume of sinker B : Weight of sinker in liquid

5.8.1. Measurement conditions

Display settings: [HOME] key  > [APP] button  > [Application] settings screen > [Application selection] button > Select [Density measurement mode].
 [HOME] key  > [Density measurement mode] screen > [Measurement conditions] screen.

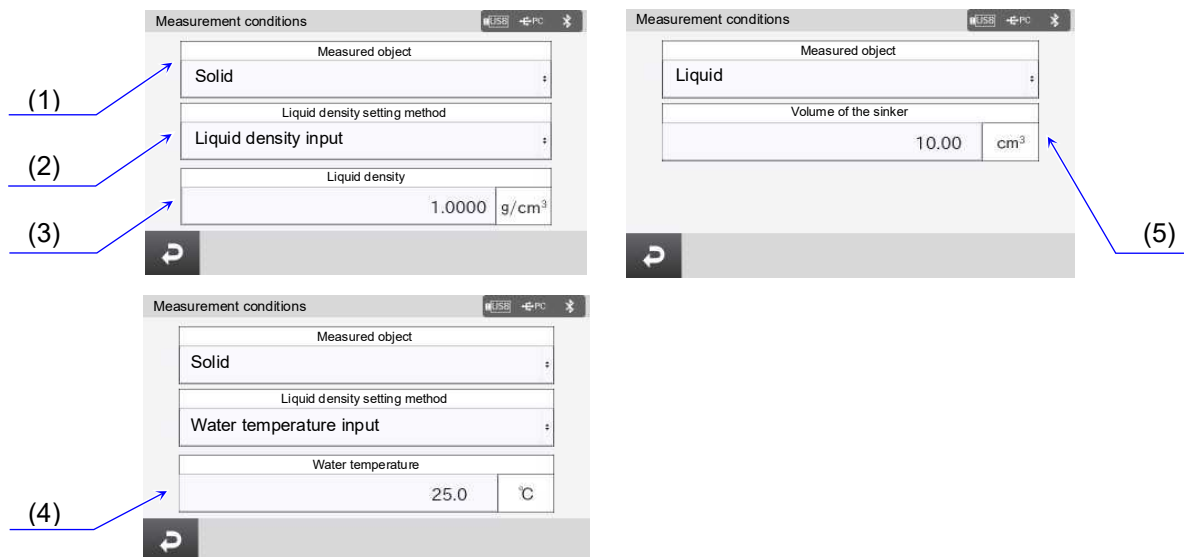



	Name	Setting value (setting range)	Description
(1)	Measured object	Solid Liquid	Selects the measured object.
(2)	Liquid density setting method	Water temperature input Liquid density input	Displayed when a solid is selected as the measured object. Select the liquid density setting method.
(3)	Liquid density	0.0000 to 1.9999	Displayed when a solid is selected as the measured object and the liquid density setting method is set to input liquid density. Enter the density of the liquid used for measurement.
(4)	Liquid temperature	0.0 to 99.9	Displayed when a solid is selected as the measured object and the liquid density setting method is set to input liquid temperature. Enter the temperature of the liquid used for measurement.
(5)	Volume of sinker	0.00 to 99.99	Displayed when a liquid is selected as the measured object. Enter the volume of the sinker used for measurement.

Water temperature and density correspondence table

°C	+0	+1	+2	+3	+4	+5	+6	+7	+8	+9
0	0.99984	0.99990	0.99994	0.99996	0.99997	0.99996	0.99994	0.99990	0.99985	0.99978
10	0.99970	0.99961	0.99949	0.99938	0.99924	0.99910	0.99894	0.99877	0.99860	0.99841
20	0.99820	0.99799	0.99777	0.99754	0.99730	0.99704	0.99678	0.99651	0.99623	0.99594
30	0.99565	0.99534	0.99503	0.99470	0.99437	0.99403	0.99368	0.99333	0.99297	0.99259
40	0.99222	0.99183	0.99144	0.99104	0.99063	0.99021	0.98979	0.98936	0.98893	0.98849

g/cm³

5.8.2. Measuring the density (specific gravity) of a solid (liquid density input)

Display settings: [HOME] key  > [APP] button  > [Application] settings screen > [Application selection] button > Select [Density measurement mode].
 [HOME] key  > [Density measurement mode] screen > [Settings] button > [Measurement conditions] screen > Select [Liquid density input].

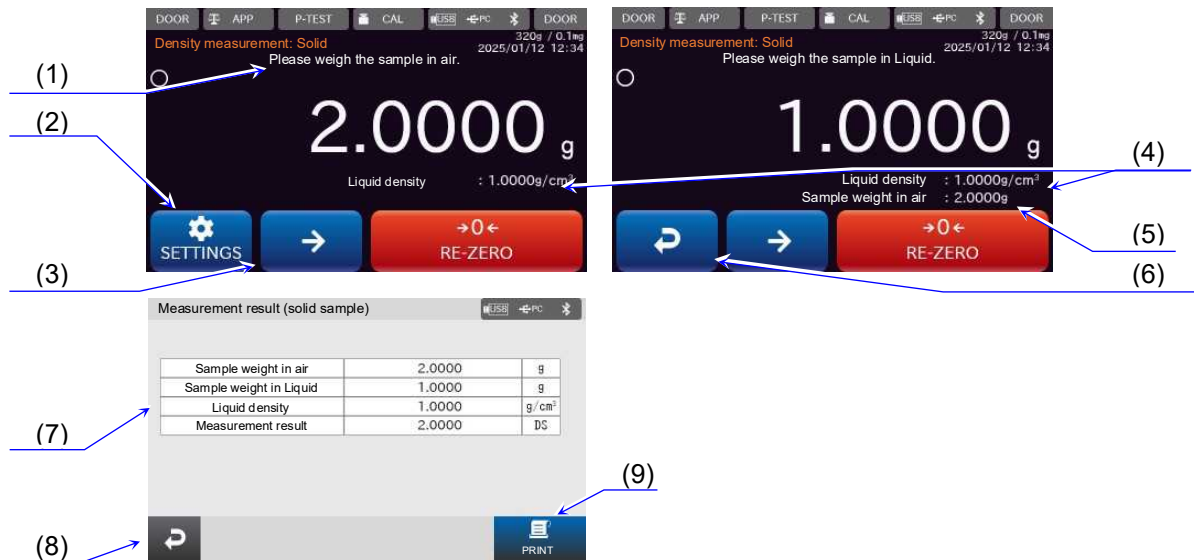



	Name	Description
(1)	Instruction display	Displays the instruction for density measurement.
(2)	[Settings] button	Displays the [Measurement conditions] screen (" 5.8.1. Measurement conditions ").
(3)	[Confirm] button	Confirms the current input setting and proceeds to the next instruction.
(4)	Liquid density display	Displays the liquid density set in the [Measurement Conditions] screen (" 5.8.1. Measurement conditions ").
(5)	Sample weight in air display	Displays the weight of the sample measured in air.
(6)	[Back] button	Returns to the sample measurement in air screen.
(7)	Measurement result display	Displays the density measurement result.
(8)	[Exit] button	Ends the density measurement and displays the [Density Measurement Mode] screen (" 5.8. Density (specific gravity) measurement function ").
(9)	[PRINT] button	Outputs the measurement results to a device connected to the balance.

Output example for solid density measurement (Liquid density input)

```
--DENSITY MODE--  
DATE 2025/01/12  
TIME 12:34:56  
-----RESULT-----  
WEIGHT IN AIR  
      2.0000 g  
WEIGHT IN LIQ  
      1.0000 g  
LIQ DENSITY  
      1.0000 g/cm3  
RESULT  
      2.0000 DS  
  
REMARKS  
  
SIGNATURE  
  
-----
```

5.8.3. Measuring the density (specific gravity) of a solid (water temperature input)

Display settings: [HOME] key  > [APP] button  > [Application] settings screen > [Application selection] button > Select [Density measurement mode].
 [HOME] key  > [Density measurement mode] screen > [Settings] button > [Measurement conditions] screen > Select [Water temperature input].

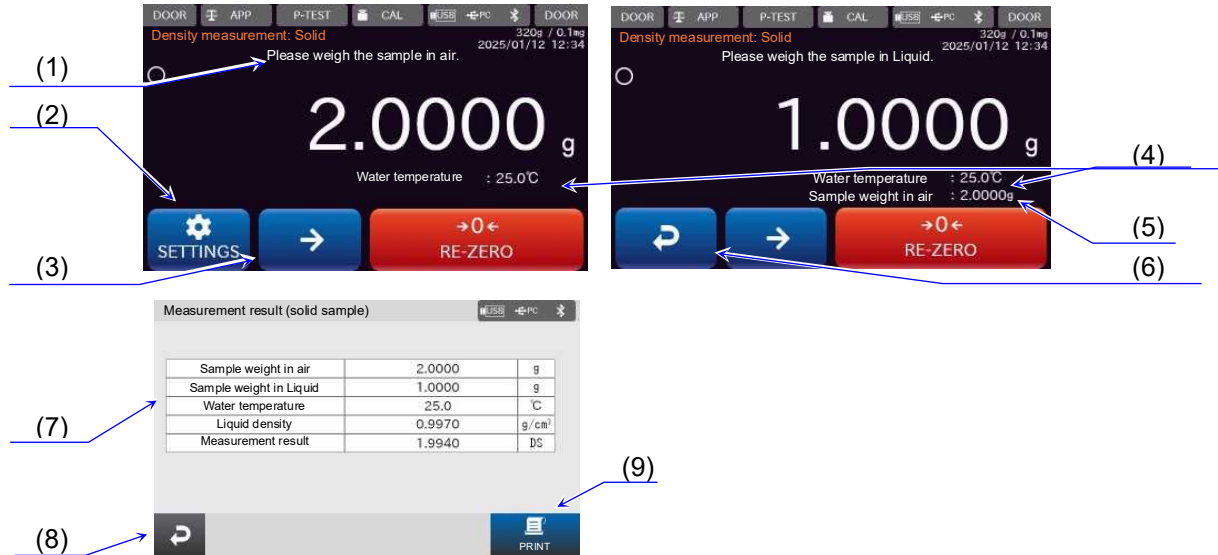



	Name	Description
(1)	Instruction display	Displays the instruction for density measurement.
(2)	[Settings] button	Displays the [Measurement conditions] screen (" 5.8.1. Measurement conditions ").
(3)	[Confirm] button	Confirms the current input setting and proceeds to the next instruction.
(4)	Liquid temperature display	Displays the liquid density set in the [Measurement Conditions] screen (" 5.8.1. Measurement conditions ").
(5)	Sample weight in air display	Displays the weight of the sample measured in air.
(6)	[Back] button	Returns to the sample measurement in air screen.
(7)	Measurement result display	Displays density measurement result.
(8)	[Exit] button	Ends the density measurement and displays the [Density Measurement Mode] screen (" 5.8. Density (specific gravity) measurement function ").
(9)	[PRINT] button	Outputs the measurement results to a device connected to the balance.

Output example for solid density measurement (Water temperature input)

```
--DENSITY MODE--  
DATE 2025/01/12  
TIME 12:34:56  
-----RESULT-----  
WEIGHT IN AIR  
      2.0000 g  
WEIGHT IN LIQ  
      1.0000 g  
WATER TEMP  
      25.0 C  
LIQ DENSITY  
      0.9970 g/cm3  
RESULT  
      1.9940 DS  
  
REMARKS  
  
SIGNATURE  
-----
```

5.8.4. Measuring the density (specific gravity) of a liquid

Display settings: [HOME] key  > [APP] button  APP > [Application] settings screen > [Application selection] button > Select [Density measurement mode].
 [HOME] key  > [Density measurement mode] screen > [Settings] button > [Measurement conditions] screen > Select [Liquid density measurement].

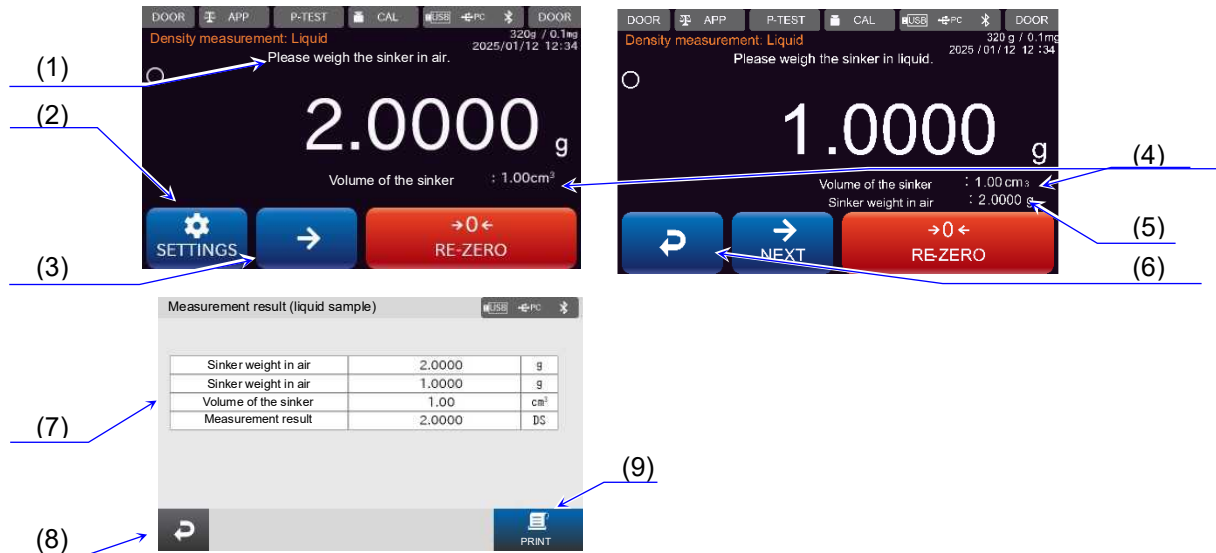

	Name	Description
(1)	Instruction display	Displays the instruction for density measurement.
(2)	[Settings] button	Displays the [Measurement conditions] screen (" 5.8.1. Measurement conditions ").
(3)	[Confirm] button	Confirms the current input setting and proceeds to the next instruction.
(4)	Volume of the sinker display	Displays the volume of the sinker set in the [Measurement Conditions] screen (" 5.8.1. Measurement conditions ").
(5)	Sinker weight in air display	Displays the weight of the sinker measured in air.
(6)	[Back] button	Returns to the sample measurement in air screen.
(7)	Measurement result display	Displays density measurement result.
(8)	[Exit] button	Ends the density measurement and displays the [Density Measurement Mode] screen (" 5.8. Density (specific gravity) measurement function ").
(9)	[PRINT] button	Outputs the measurement results to a device connected to the balance.

Output example for liquid density measurement

```
--DENSITY MODE--  
DATE 2025/01/12  
TIME 12:34:56  
-----RESULT-----  
WEIGHT IN AIR  
      2.0000 g  
WEIGHT IN LIQ  
      1.0000 g  
VOLUME  
      1.00 cm3  
RESULT  
      2.0000 DS  
  
REMARKS  
  
SIGNATURE  
  
-----
```

5.9. Statistical calculation function

Usage

This mode processes weighing values statistically and displays/outputs the result.

Calculation items available for display/output include the number of data, sum, maximum, minimum, range (Max-Min), mean, standard deviation, coefficient of variation and relative error. You can select these output data in four steps on the [Statistical calculation setting] screen ("[5.9.1. Statistical calculation results](#)").

You can delete incorrectly input data from the [Statistical calculation results] screen ("[5.9.1. Statistical calculation results](#)").

Statistical results are initialized if the statistical calculation function is disabled or the power is turned off.

The standard deviation, coefficient of variation and relative error are calculated with the following formulas.

$$\text{Standard deviation} = \sqrt{\frac{N \cdot \sum(X_i)^2 - (\sum X_i)^2}{N \cdot (N - 1)}} \quad \text{Where } X_i \text{ is the } i\text{th weighing value and } N \text{ is the number of data.}$$

$$\text{Coefficient of variation (CV)} = \frac{\text{Standard deviation}}{\text{Mean}} \cdot 100 (\%)$$

$$\text{Relative error of the maximum value (MAX\%)} = \frac{\text{Maximum} - \text{Mean}}{\text{Mean}} \cdot 100 (\%)$$



$$\text{Relative error of the minimum value (MIN\%)} = \frac{\text{Minimum} - \text{Mean}}{\text{Mean}} \cdot 100 (\%)$$

If the minimum display digit is disabled for any data, the calculation result is displayed with the minimum display digit disabled.

(The minimum display digit is rounded off)

If the statistical calculation function is enabled, you cannot change the application, unit of measure or readability.

If you configure this display, the [HOME] screen changes to the weighing screen with the statistical calculation function.

Display settings: [HOME] key  > [APP] button  > [Application] settings screen > [Statistical calculation function] button > Select [ON].

[HOME] key  > Weighing screen with the statistical calculation function.

(1)

[Statistical calculation results] button

(2) [PRINT] button





	Name	Description
(1)	[Statistical calculation results] button	Displays the [Statistical calculation results] screen (" 5.9.1. Statistical calculation results "). Also displays the number of input data. The number of data is displayed within the range from 000 to 999.
(2)	[PRINT] button	Adds data to be used for statistical calculation. Also outputs data to the device connected to the balance.

This is the screen for the statistical calculation function.

5.9.1. Statistical calculation results

Display settings for statistical calculation results

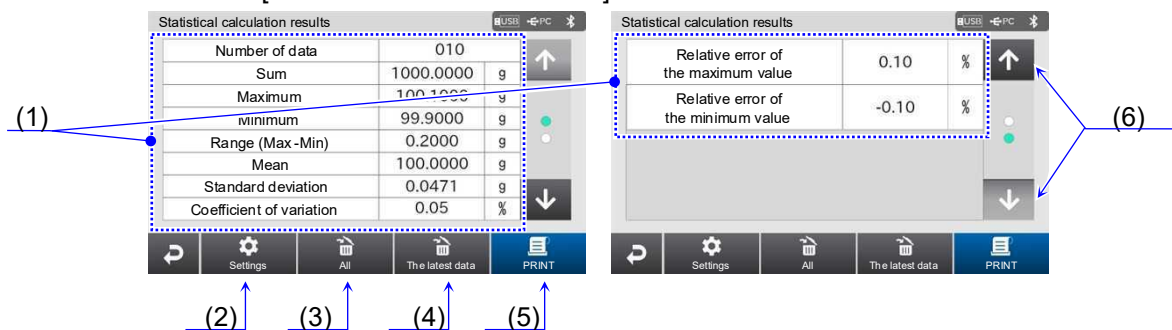

Display settings: [HOME] key  > [APP] button  > [Application] settings screen > [Statistical calculation function] button > Select [ON].
 [HOME] key  > Weighing screen with the statistical calculation function > [Statistical calculation results] button.



	Name	Description
(1)	Statistical calculation results area	Displays the statistical calculation results.
(2)	[Statistical calculation setting] button	Displays the [Statistical calculation setting] screen.
(3)	[Delete all] button	Deletes all statistical calculation data.
(4)	[Delete latest data] button	Deletes the latest statistical calculation data.
(5)	[PRINT] button	Outputs the statistical calculation results to the device connected to the balance.
(6)	[Page navigation] buttons	Navigates to the previous/next statistical calculation results page.

This is the screen for the statistical calculation results.

Display settings for the statistical calculation setting

Display settings: [HOME] key  > [APP] button  > [Application] settings screen > [Statistical calculation function] button > Select [ON].
 [HOME] key  > Weighing screen with the statistical calculation function > [Statistical calculation results] button > [Statistical calculation setting] button.

(1) Statistical display output

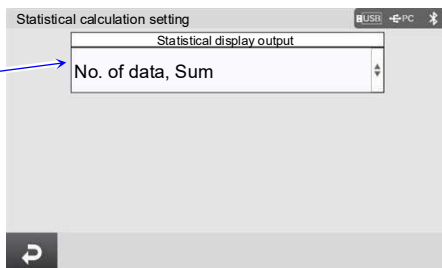

	Name	Setting value	Description
(1)	Statistical display output	<ul style="list-style-type: none"> • No. of data, Sum. • No. of data, Sum, Max, Min, Range, Mean • No. of data, Sum, Max, Min, Range, Mean, SD, CV • No. of data, Sum, Max, Min, Range, Mean, SD, CV, Relative error 	Selects the display/output for statistical calculation results.

Settings in the red box are default values (factory settings).

❑ This is the screen for selecting the statistical calculation display.

5.9.2. Statistical calculation output example

Registering data

Press the [PRINT] button  in the weighing screen.

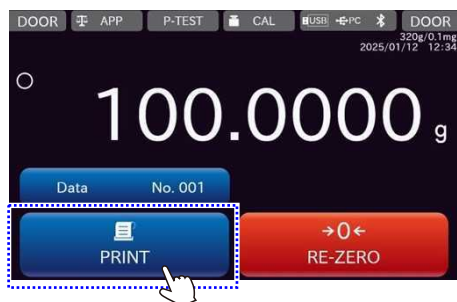

```
No. 1
ST, +0100.0000 g
```

Outputting results

Press the [PRINT] button  in the [Statistical calculation results] screen.

Statistical display output: Number of data, Sum, Maximum, Minimum, Range, Mean, Standard deviation, Coefficient of variation, Relative error.

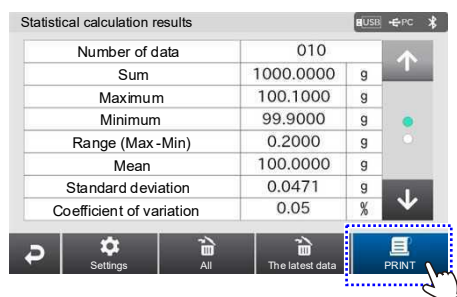

The image shows the 'Statistical calculation results' screen. It features a table with the following data:



Statistical calculation results		
Number of data	010	
Sum	1000.0000	g
Maximum	100.1000	g
Minimum	99.9000	g
Range (Max-Min)	0.2000	g
Mean	100.0000	g
Standard deviation	0.0471	g
Coefficient of variation	0.05	%

At the bottom, there are buttons for 'Settings', 'All', 'The latest data', and a 'PRINT' button (highlighted with a red dashed box and a mouse cursor).

```
N          10
SUM
+1000.0000 g
MAX +100.1000 g
MIN +99.90000 g
R      +0.2000 g
AVE +100.0000 g
SD      +0.0471 g
CV       +0.05 %
MAX%    +0.10 %
MIN%    -0.10 %
```

5.10. Capacity indicator

- If you configure this display, the [HOME] screen changes to the weighing screen with the capacity indicator.

Display settings: [HOME] key  > [APP] button  > [Application] settings screen > [Capacity indicator] button > Select [ON].
 [HOME] key  > Weighing screen with the capacity indicator.



(1) Capacity indicator

	Name	Description
(1)	Capacity indicator	Displays the capacity indicator. Displays the current weight as a blue bar with the capacity as 100 %.

5.11. Net/gross/tare function

Net/gross/tare function usage

- ❑ The net/gross/tare functions allow you to output data for the gross weight, net weight and tare weight by optionally subtracting the tare.
- ❑ Change to the Gross weight/Tare weight display as follows:
 - Display settings: [HOME] key > [APP] button > [Application] settings screen > Gross weight/Tare weight display button > Select [ON].
 - [HOME] key > Weighing screen with the Gross weight/Tare weight display function.
- ❑ When this function is enabled, the [TARE] button for subtracting the tare is added.

CAUTION

- ❑ To output all of the net weight, gross weight and tare weight, configure the following data output settings.
 - Display settings: [MENU] key > [System Settings] button > [Communication] button > [Data output] button.
 - [Data to be added] button > Gross weight/Tare weight display button > Select [Gross weight + Tare weight].





	Name	Description	
(1)	G/NET display	Displays the gross or net indicator. G (gross): Displayed when the tare weight is zero. NET (net): Displayed when the tare weight is non-zero.	
(2)	Gross weight/Tare weight display	Displays the current gross weight and tare weight.	
(3)	[RE-ZERO] button*1	Gross value: Within the zero range*2	Updates the zero point and clears the tare weight.
		Gross value: Exceeding the zero range*2	Performs the same operation as with the [TARE] button.
(4)	[TARE] button	Gross value: Positive value	Performs tare operation and updates the tare weight.
		Gross value: Gross zero*3	Clears the tare weight.
		Gross value: Negative value	Does not subtract the tare.

*1 Regardless of the weighing value, zero is displayed.

*2 For details about the zero range, refer to "5.2.2. Zero-point, tare, and weighing range".

*3 "Gross zero" means that the gross weight minimum division is in the range of zero when the unit is "g".



5.12. Warning display

- ❑ Two types of warnings can be displayed according to the situation.
- ❑ Enable the warning display as follows:
 - Display settings: [HOME] key  > [APP] button  > [Application] settings screen > [Warning display] button > Select [ON]. (Factory setting).
 - [HOME] key  > Weighing screen with the warning display function.



(1) Warning display

	Name	Description
(1)	Warning display	Displays two types of warnings according to the situation of the balance.

Warning display	Name	Description	Display priority
	Shock indicator	Displayed by the shock detection function.	High
	Static elimination recommended	Displayed when the relative humidity inside the balance is 45% or less. (Lights up for about 30 seconds after the start of weighing)	Low





5.12.1. Impact shock detection (ISD) function

- ❑ Impact shock detection (ISD) function is a feature installed in the BH-T series that detects impact shocks to the mass sensor section, displays the impact level, and records it.
- ❑ By lowering the impact level at the time of loading, it is possible not only to alleviate variation in the weighing value but also to reduce the risk of failure of the mass sensor section. Especially when incorporating the balance in a production line, etc., and weighing by means such as an automated system, impact greater than expected may be applied to the sensor. When designing automatic systems and the like, it is recommended that you minimize the impact level as much as possible while checking the shock indicator.
- ❑ Impacts of impact level 3 or higher are stored on the balance with date and time.
For details, refer to "[13.32. Impact shock detection history](#)".
- ❑ You can hide the impact level by turning off the [Warning display] button.
If the impact level is level 3 or higher, the record will be kept automatically even if the impact level is hidden.



CAUTION

- ❑ Impact on the weighing sensor is not only that applied to the weighing pan when loaded, but also may be impact applied from the table on which the balance is installed. The impact detection function also works for impact coming from the table.

The shock indicator has 5 levels from level 0 to level 4.

Impact level	Shock indicator	Buzzer	Contents and measures
Level 0	No indicator	No indicator	Safe
Level 1			CAUTION
Level 2			Caution: Alleviate impact shocks
Level 3		One beep	Warning: Do not apply any more impact shocks
Level 4		Two beeps	Danger: Sensor may be damaged

6. Quick Performance Check: [Repeatability Measurement] Screen



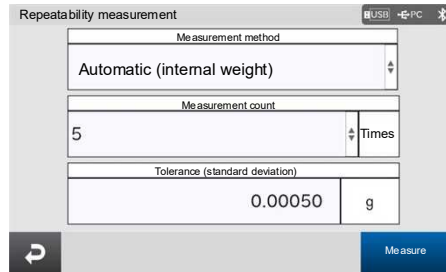

- ❑ You can access the quick performance check from the weighing screen with a single touch.
- ❑ Display the quick performance check as follows:
Display settings: [HOME] key  > [P-TEST] button  > [Repeatability measurement] screen.





Quick performance check usage

- ❑ The quick performance check screen is common to the repeatability check screen described in "[11.3. Repeatability check](#)".
For details about setting each item, refer to "[11.3. Repeatability check](#)".

7. Communication Device

- ❑ Configure the simplified settings for the communication device connected to the balance.
The location of the [Communication device] button corresponding to the connected device is lit in blue.
- 
- ❑ You can configure settings such as the data format as follows:
Display settings: [MENU] key  > [System Settings] button  > [Communication] button  > [Communication] screen.

7.1. [Communication device] – [USB flash drive] settings

- ❑ Display the [USB flash drive] tab in the [Communication device] screen as follows:
Display settings: Weighing screen > [Communication device] button  > [USB flash drive] button .

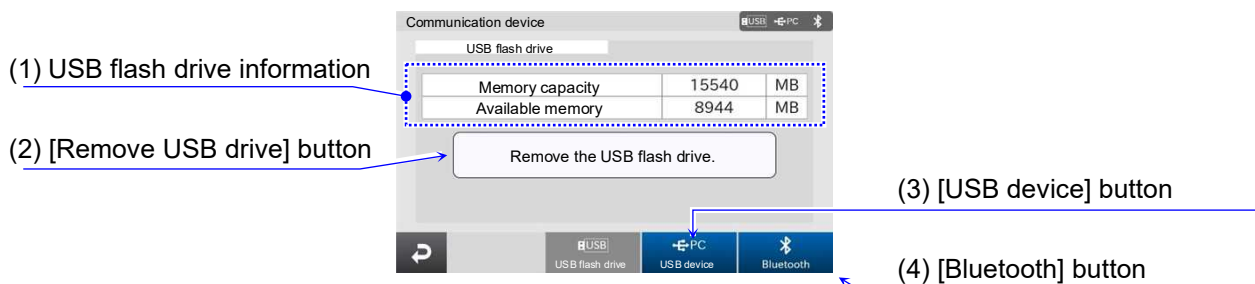

	Name	Description
(1)	USB flash drive information	Displays the information about the connected USB flash drive.
(2)	[Remove USB drive] button	Removes the USB flash drive.
(3)	[USB device] button	Displays the [Communication device] - [USB device] settings screen (" 7.2. [Communication device] - [USB device] settings ").
(4)	[Bluetooth] button	Displays the [Communication device] - [Bluetooth] settings screen (" 7.3. [Communication device] - [Bluetooth] settings ").

CAUTION





- ❑ For details about handling the USB flash drive, refer to "[15.3. USB flash drive \(USB host\)](#)".

USB flash drive usage

- ❑ For the BH-T series, you can connect the USB flash drive through the USB host interface.
You can save weighing data, etc. in the USB flash drive and import the data into Windows or macOS computers easily (no driver is required).

7.2. [Communication device] - [USB device] settings

- Display the [USB device] tab in the [Communication device] screen as follows:

Display settings: Weighing screen > [Communication device] button    > [USB device] button .

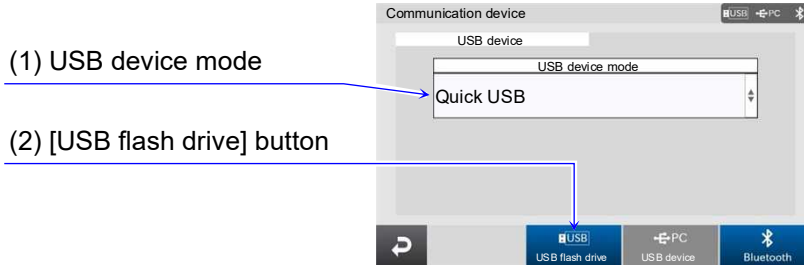

	Name	Setting value (setting range)	Description
(1)	USB device mode	Quick USB , Virtual COM	Selects the communication method between the balance and computer.
(2)	[USB flash drive] button	-	Displays the [USB flash drive] settings screen ("7.1. [Communication device] – [USB flash drive] settings").





Settings in the red box are default values (factory settings).

Note

- You can use the USB-C connector equipped as standard to connect the balance to PC. For details about the communication method, refer to "13.17. USB interface".

7.3. [Communication device] - [Bluetooth] settings

- Display the [Bluetooth] tab in the [Communication device] screen as follows:

Display settings: Weighing screen > [Communication device] button    > [Bluetooth] button .

(1) Bluetooth mode

(2) Connection status

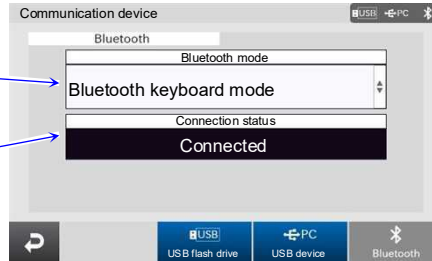

	Name	Setting value (setting range)	Description
(1)	Bluetooth mode	Bluetooth keyboard mode, Bluetooth serial mode	Switches the Bluetooth mode.
(2)	Connection status	-	Displays the Bluetooth connection status.

 Settings in the red box are default values (factory settings).

Note





- Bluetooth allows the balance to be connected to computers and other devices.
For details about the communication method, refer to "13.19. Bluetooth".

8. Password Function

Intended use

- ❑ The password function allows you to restrict the use and functions of the balance.
It is effective in preventing falsification of date and time settings or preventing changes in the function table by the user.

Operation

- ❑ To log in, press the [LOG-IN] key  when the display is on, input the user name and password in the [Log-in] screen, and press the [Log-in] button .
- ❑ To log out, press the [Log-out] button  or [ON:OFF] key  to turn the display off.

How to manage balance functions/usage and factory settings

- ❑ User level
You can restrict functions at each user level.
At the factory setting, all functions are allowed at each user level.
There are four user levels: Administrator, Lab manager, Supervisor and Operator.
Users can select the Lab manager and Supervisor user levels.
Users who are not logged in are an Operator. (Users who do not use the password function)
- ❑ Admin (Administrator)
Only the Administrator can restrict functions. Refer to "[8.2. User authorization](#)".
The Administrator is registered before shipment and you cannot delete this user or change the user level of this user.
The password of the Administrator is "0000" at the factory setting. Be sure to change the password of the Administrator if you want to use the password function. If the password of the Administrator is lost or forgotten, you cannot manage users or change user authorization.
Password reset requires repair at the manufacturer. Contact your local A&D dealer for repairs.

8.1. [Log-in] screen

- Display the [Log-in] screen as follows:

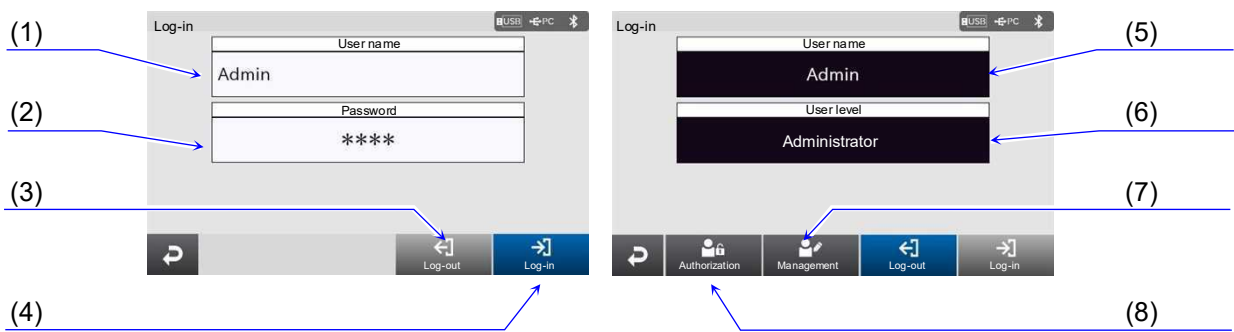

Display settings: Weighing screen > [LOG-IN] key  > [Log-in] screen.



	Name	Description
(1)	User name input field	Input the user name for login. The length of user names is up to 20 characters.
(2)	Password input field	Input the set password. The password consists of alphanumerics with a length of 4 characters.
(3)	[Log-out] button	Logs out. Note: You can also press the [ON:OFF] key  to turn the display off and log out.
(4)	[Log-in] button	Logs in.
(5)	Log-in user name	Displays the logged in user name.
(6)	Log-in user level	Displays the user level of the logged in user.
(7)	[User management] button	Displays the [User management] screen (" 8.3. User management "). Note: Displayed only when the user is logged in as the Administrator.
(8)	[User authorization] button	Displays the [User authorization] settings screen (" 8.3. User management "). Note: Displayed only when the user is logged in as the Administrator.

8.2. User authorization

- Display the [Log-in] screen as follows:

Display settings: Weighing screen > [LOG-IN] key  > [User authorization] button  > [User authorization] settings screen.

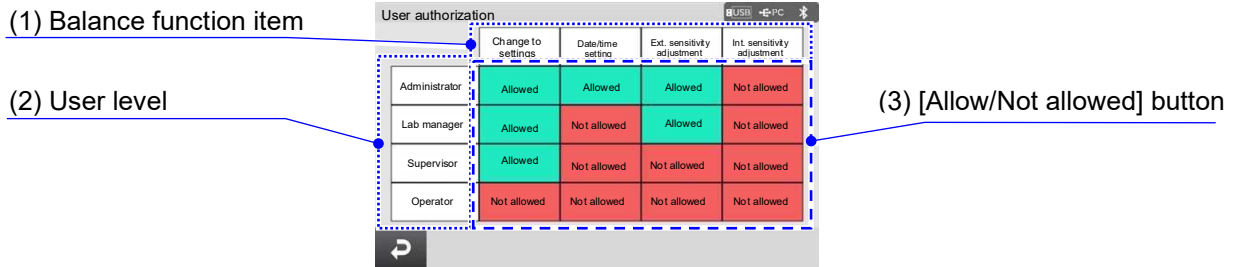

	Name	Description
(1)	Balance function item	Balance functions to restrict.
(2)	User level	User levels at which functions are restricted.
(3)	[Allow/Not allowed] button	These buttons switch between [Allowed] and [Not allowed] for the corresponding function at the restricted user level. At the factory setting, all functions are allowed at each user level.

8.2.1. User authorization - Change to settings not allowed

If changes to settings are not allowed in user authorization, the following buttons are disabled.



[MENU] screen - System settings

Display settings: [MENU] key  > [Menu] screen.

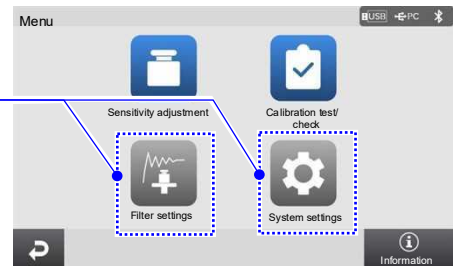
Disabled button





Sensitivity adjustment - Settings

Display settings: [MENU] key  > [Sensitivity adjustment] button  > [Sensitivity adjustment] screen.

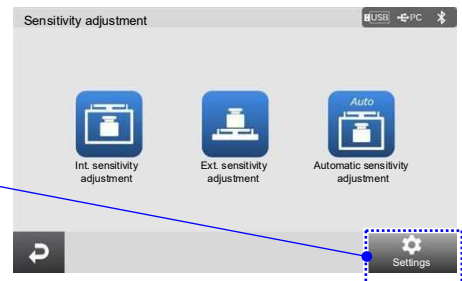
Disabled button



Calibration test/check screen - Settings



Display settings: [MENU] key  > [Calibration test/check] button  > [Calibration test/check] screen.

Note: There is a button for navigating to the same settings screen during a periodic check. This button is also disabled.

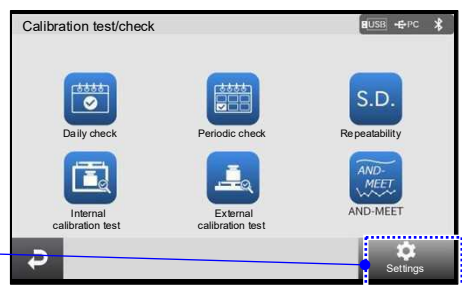
Disabled button



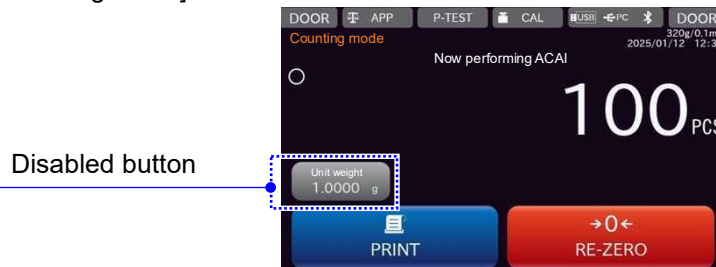

Counting mode screen - Counting mode setting

Display settings: [HOME] key  > [APP] button  > [Application] settings screen > [Application selection] button > Select [Counting mode].
[HOME] key  > [Counting mode] screen.



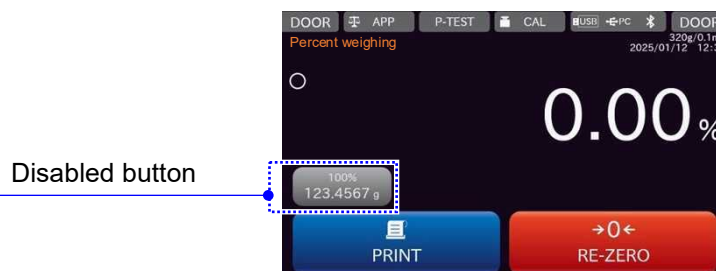

Percent weighing screen - Percent mode setting

Display settings: [HOME] key  > [APP] button  > [Application] settings screen > [Application selection] button > Select [Percent mode].
[HOME] key  > [Percent weighing] screen.



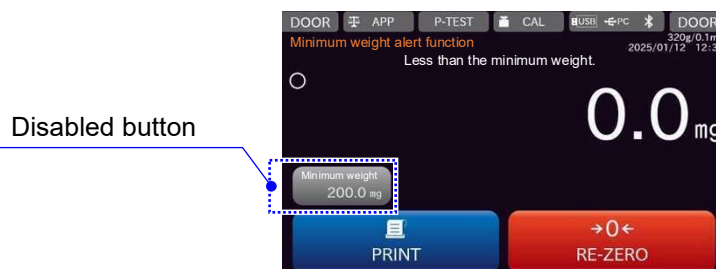

Weighing screen with the minimum weight alert function - Minimum weight setting

Display settings: [HOME] key  > [APP] button  > [Application] settings screen > [Application selection] button > Select [Minimum weight alert function].
[HOME] key  > Weighing screen with the minimum weight alert function.



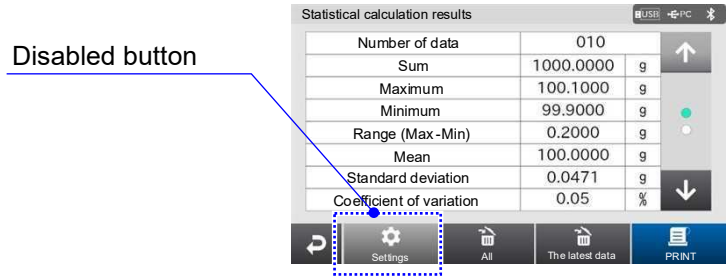

Statistical calculation results screen - Setting

Display settings: [HOME] key  > [APP] button  > [Application] settings screen > [Statistical calculation function] button > Select [ON].
 [HOME] key  > Weighing screen with the statistical calculation function > [Statistical calculation results] button.



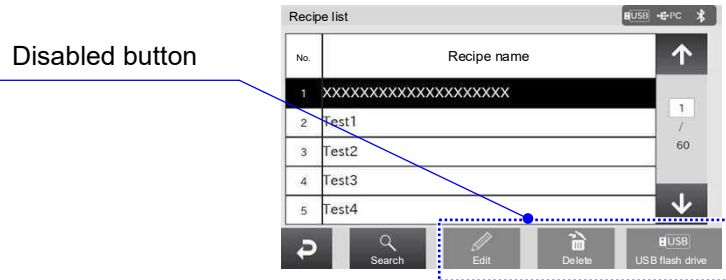

Formulation mode - Recipe list

Display settings: [HOME] key  > [APP] button  > [Application] settings screen > [Application selection] button > Select [Formulation mode].
 [HOME] key  > [Formulation mode] screen > [Go to the recipe list] button > [Recipe list] screen.



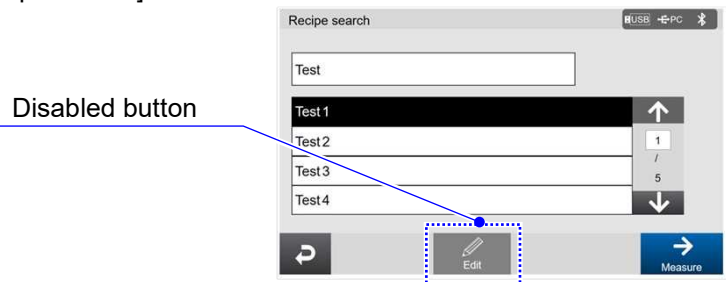

Formulation mode - Recipe search

Display settings: [HOME] key  > [APP] button  > [Application] settings screen > [Application selection] button > Select [Formulation mode].
 [HOME] key  > [Formulation mode] screen > [Go to the recipe list] button > [Search] button > [Recipe search] screen.





HPLC mode - Recipe list

Display settings: [HOME] key  > [APP] button  > [Application] settings screen > [Application selection] button > Select [HPLC mode].
[HOME] key  > [HPLC mode] screen > [Go to the recipe list] button > [Recipe list] screen.

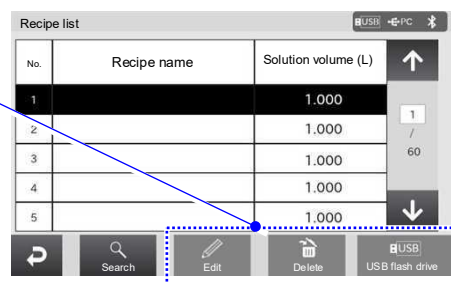
Disabled button



HPLC mode - Recipe search

Display settings: [HOME] key  > [APP] button  > [Application] settings screen > [Application selection] button > Select [HPLC mode].
[HOME] key  > [HPLC mode] screen > [Go to the recipe list] button > [Search] button > [Recipe search] screen.

Disabled button

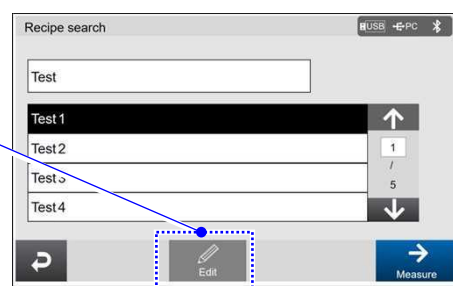

8.2.2. User authorization - Date/time setting not allowed

If the date/time setting is not allowed in user authorization, the following button is disabled.

System settings - Date/time setting

Display settings: [MENU] key  > [System Settings] button  > [System settings] screen.

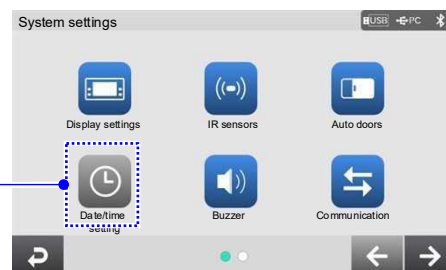

Disabled button



8.2.3. User authorization - Ext. sensitivity adjustment not allowed

If external calibration adjustment is not allowed in user authorization, the following buttons are disabled.

Sensitivity adjustment - Ext. sensitivity adjustment

Display settings: [MENU] key  > [Sensitivity adjustment] button  > [Sensitivity adjustment] screen.

Disabled button

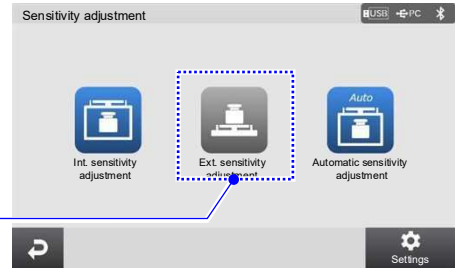



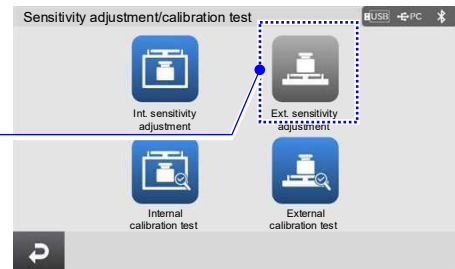

Sensitivity adjustment/calibration test - Ext. sensitivity adjustment

Display settings: [HOME] key  > [CAL] button  > [Sensitivity adjustment/calibration test] screen.

Disabled button



Periodic check - Sensitivity adjustment, Daily check - Sensitivity adjustment

Display settings: [MENU] key  > [Calibration test/check] button  > [Daily check] button  > [Sensitivity adjustment] screen, or [Periodic check] button  > [Sensitivity adjustment] screen.

Note: If an external weight is used, the [Execute] button is disabled.

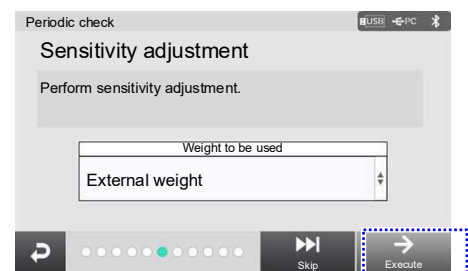

Disabled button



8.2.4. User authorization - Int. sensitivity adjustment not allowed

If internal sensitivity adjustment is not allowed in user authorization, the following buttons are disabled. In addition, when a user at a user level where the internal sensitivity adjustment is not allowed is logged in, the [Automatic sensitivity adjustment] button is also not allowed and no automatic sensitivity adjustment is performed.

Sensitivity adjustment - Int. sensitivity adjustment

Display settings: [MENU] key  > [Sensitivity adjustment] button  > [Sensitivity adjustment] screen.

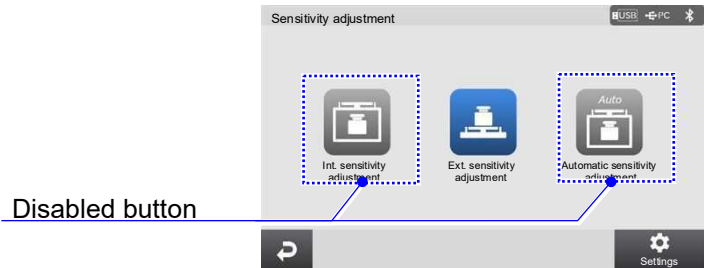



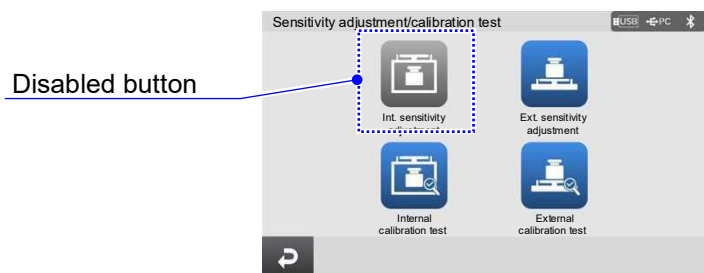

Sensitivity adjustment/calibration Test - Int. sensitivity adjustment

Display settings: [HOME] key  > [CAL] button  CAL > [Sensitivity adjustment/calibration test] screen.



Periodic check - Sensitivity adjustment, Daily check - Sensitivity adjustment

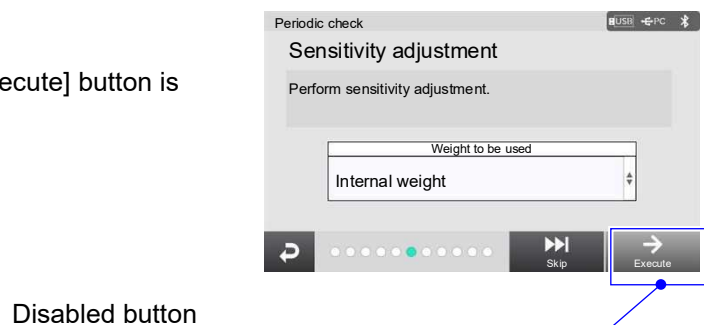

Display settings: [MENU] key  > [Calibration test/check] button  > [Daily check] button , or [Periodic check] button  > [Sensitivity adjustment] screen.

Note: If an external weight is used, the [Execute] button is disabled.



8.3. User management

- Display the [User management] screen as follows:

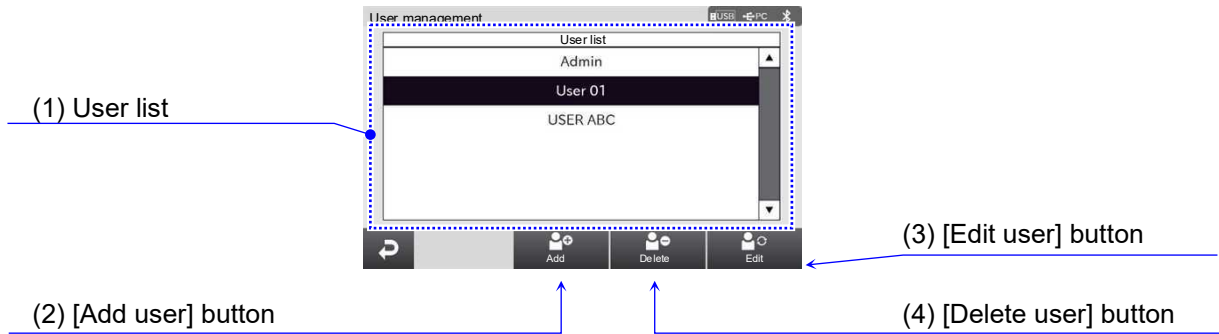

Display settings: Weighing screen > [LOG-IN] key  > [User management] button  > [User management] screen.



	Name	Description
(1)	User list	Displays the registered users. Only Admin is registered at the factory setting. Up to 100 users can be registered. When you want to register or delete a user, select the target user.
(2)	[Add user] button	Displays the [User management] (Register) screen for registration described in "8.3.1. User management for registration".
(3)	[Edit user] button	Displays the [User management] (Edit) screen for edit described in "8.3.2. User management for edit".
(4)	[Delete user] button	Delete the selected user. A confirmation dialog is displayed before deletion. You cannot delete Admin.

8.3.1. User management for registration

- Display the [User management] screen for registration as follows:

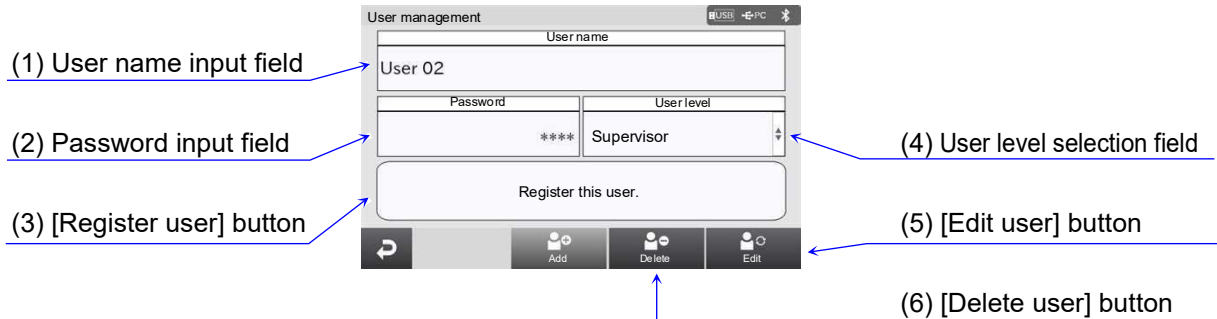

Display settings: Weighing screen > [LOG-IN] key  > [User management] button  > [Add user] button > [User management] screen for registration.



	Name	Description
(1)	User name input field	Set the user to register. The length of user names is up to 20 characters.
(2)	Password input field	Set the password to register. The password consists of alphanumeric characters with a length of 4 characters.
(3)	[Register user] button	Registers the set user.
(4)	User level selection field	Set the user level to register. Select either [Supervisor] or [Lab manager].
(5)	[Edit user] button	Displays the [User management] (Edit) screen for edit described in " 8.3.2. User management for edit ".
(6)	[Delete user] button	Displays the [User management] screen described in " 8.3. User management ". Displays the user list.

8.3.2. User management for edit

- Display the [User management] screen for edit as follows:

Display settings: Weighing screen > [LOG-IN] key  > [User management] button  > [Edit user] button > [User management] screen for edit.

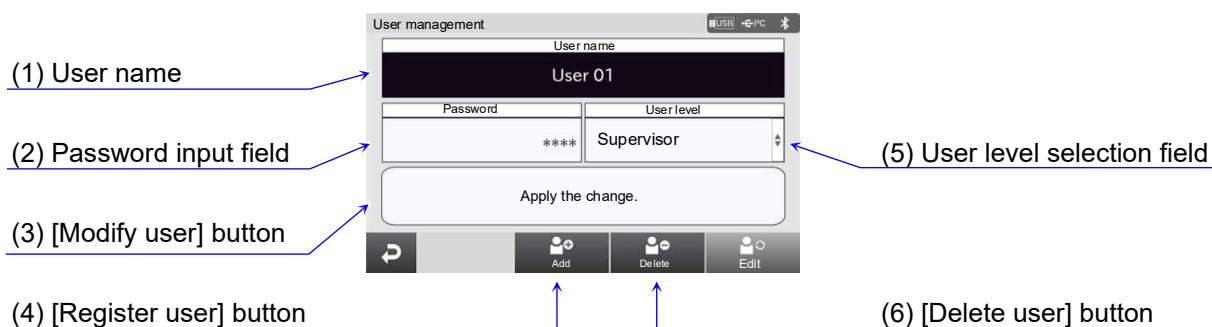

	Name	Description
(1)	User name	Displays the user to be modified.
(2)	Password input field	Set the password to register. The password consists of alphanumerics with a length of 4 characters.
(3)	[Modify user] button	Applies the set password and user level.
(4)	[Register user] button	Displays the [User management] screen for registration described in " 8.3.1. User management for registration ".
(5)	User level selection field	Set the user level to register. Select either [Supervisor] or [Lab manager].
(6)	[Delete user] button	Displays the [User management] screen described in " 8.3. User management ". Displays the user list.

9. [MENU] Screen

□ Display the [Menu] screen as follows:



Display settings: [MENU] key  > [Menu] screen.



	Name	Description
(1)	[Sensitivity adjustment] button	Displays the [Sensitivity adjustment] screen ("10. [Sensitivity Adjustment] Screen"). You can configure the operation and settings for the internal sensitivity adjustment and external sensitivity adjustment.
(2)	[Filter Settings] button	Displays the [Filter settings] screen ("12. Filter Settings"). You can configure the response characteristics, stability bandwidth and zero tracking settings.
(3)	[Back] button	Displays the weighing screen.
(4)	[Calibration test/check] buttons	Displays the [Calibration test/check] screen ("11. Calibration Test/Check"). You can configure the operation and settings for the daily check, periodic check, repeatability check, etc.
(5)	[System Settings] button	Displays the [System settings] screen ("13. System Settings"). You can configure settings for the display, buttons, IR sensors, communication language, clock, etc.
(6)	[Information] button	Displays the [Information] screen ("13.25. Balance status"). You can check the balance information, software version and history.

10. [Sensitivity Adjustment] Screen

- Display the [Sensitivity adjustment] screen as follows:

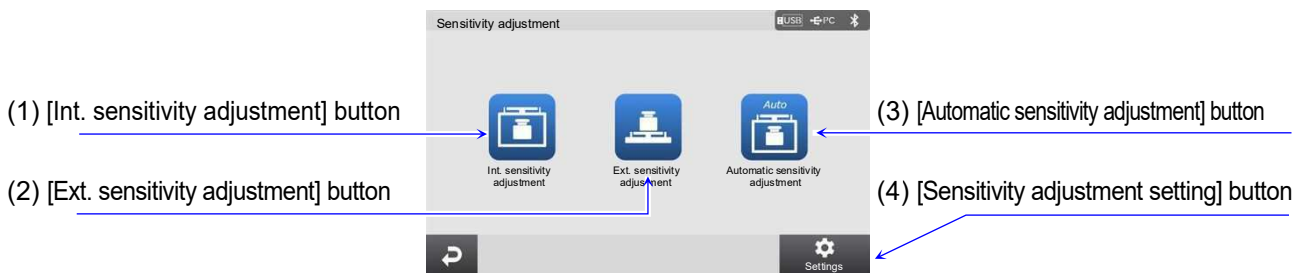

Display settings: [MENU] key  > [Sensitivity adjustment] button  > [Sensitivity adjustment] screen.





	Name	Description
(1)	[Int. sensitivity adjustment] button	Displays the [Internal sensitivity adjustment] screen to execute the internal sensitivity adjustment ("10.1. Internal sensitivity adjustment"). After adjustment, the [Sensitivity adjustment result] screen for the internal sensitivity adjustment is displayed.
(2)	[Ext. sensitivity adjustment] button	Displays the [External sensitivity adjustment] screen to start the external sensitivity adjustment ("10.2. External sensitivity adjustment"). After adjustment, the [Sensitivity adjustment result] screen for the external sensitivity adjustment is displayed.
(3)	[Automatic sensitivity adjustment] button	Displays the [Automatic sensitivity adjustment] settings screen ("10.3. Automatic sensitivity adjustment"). The automatic sensitivity adjustment is executed.
(4)	[Sensitivity adjustment setting] button	Displays the [Sensitivity adjustment setting] screen ("10.4. Sensitivity adjustment setting"). You can configure the settings for the [CAL] button, standard value for external weight values and internal weight value correction for the weighing screen.



- Since the balance's resolution is high, weighing values may change due to gravity and daily environmental changes. It is necessary to perform sensitivity adjustment with the weight in order to keep the weighing values from changing even if gravity or the environment changes.
It is advisable to perform sensitivity adjustment when the balance is newly installed or relocated, or if significant deviations in weighing values are observed during daily checks.
- Sensitivity adjustment involves calibrating the balance's weighing values using a reference weight or the internal weight.

Caution on sensitivity adjustment

- **Do not allow vibration, drafts or temperature changes to affect the balance especially during sensitivity adjustment.**
- The GLP/GMP (etc.) compliant report can be output in sensitivity adjustment. A computer or optional printer is required for GLP output. A timestamp (clock and calendar) is available for the GLP output using the clock function of the balance.
- You can set the clock function from the [Date/time setting] screen.
Display settings: [MENU] key  > [System Settings] button  > [Date/time] button  > [Date/time setting] screen.

10.1. Internal sensitivity adjustment

Display settings 1: [MENU] key  > [Sensitivity adjustment] button  > [Int. sensitivity adjustment] button  > [Internal sensitivity adjustment] screen.

Display settings 2: [HOME] key  > [CAL] button  CAL > [Int. sensitivity adjustment] button  > [Internal sensitivity adjustment] screen.



	Name	Description
(1)	[Back] button	Returns to the previous screen.
(2)	Date	Displays the date when the internal sensitivity adjustment was complete.
(3)	Time	Displays the time when the internal sensitivity adjustment was complete.
(4)	Weight used	Displays the weight used.
(5)	[PRINT] button	Outputs the sensitivity adjustment result.*

* It is automatically output if either [GLP output] or [GLP custom output] is set for [GLP output/Label output].



The balance performs sensitivity adjustment using the internal weight.



- Be sure to warm up the balance with nothing on the weighing pan for at least an hour.
- Do not apply vibration and the like to the balance during sensitivity adjustment.
- When the adjustment is complete, the [Sensitivity adjustment result] screen for the internal sensitivity adjustment is automatically displayed.

About the internal weight

- The value of the internal weight may change due to factors such as the operating environment and aging.
- Correct the internal weight value as necessary by referring to "10.5. Correcting the internal weight value".
- In order to maintain the weighing accuracy, it is advisable to perform the external sensitivity adjustment regularly ("10.2. External sensitivity adjustment").

10.2. External sensitivity adjustment

Display settings 1: [MENU] key  > [Sensitivity adjustment] button  > [Ext. sensitivity adjustment] button  → [External sensitivity adjustment] screen.

Display settings 2: [HOME] key  > [CAL] button  CAL > [Ext. sensitivity adjustment] button  > [External sensitivity adjustment] screen.

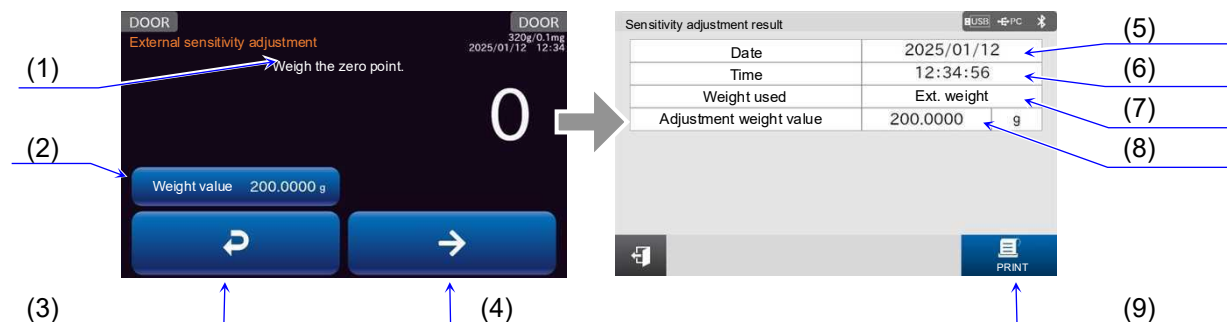

	Name	Description
(1)	Instruction display	Displays the instruction for external sensitivity adjustment.
(2)	External weight value input field	Input the external weight value. This is common to the external weight value input field in the [Sensitivity adjustment result] screen for external sensitivity adjustment. Input range BH-225TE / BH-225DTE: 9.9 g to 200 g to 200.1 g BH-324TE: 9.9 g to 200 g to 300.1 g BH-224TE: 9.9 g to 200 g to 200.1 g
(3)	[Back] button	Returns to the previous screen.
(4)	[Confirm] button	Confirms the current input setting and proceeds to the next instruction.
(5)	Date	Displays the date when the external sensitivity adjustment was complete.
(6)	Time	Displays the time when the external sensitivity adjustment was complete.
(7)	Weight used	Displays the type of the weight used.
(8)	Adjustment weight value	Displays the weight value used.
(9)	[PRINT] button	Outputs the sensitivity adjustment result.*

Settings in the red box are default values (factory settings).

* It is automatically output if either [GLP output] or [GLP custom output] is set for [GLP output/Label output].

This function performs sensitivity adjustment of the balance using an external weight.











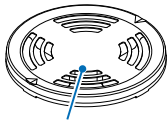

- Be sure to warm up the balance with nothing on the weighing pan for at least an hour.
- Do not apply vibration and the like to the balance during sensitivity adjustment.
- When the adjustment is complete, the [Sensitivity adjustment result] screen for the external sensitivity adjustment is automatically displayed.

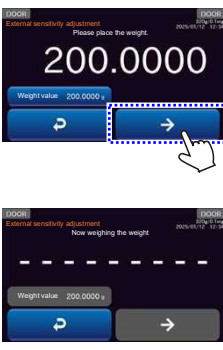
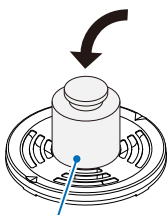
CAUTION

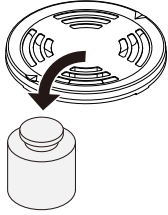

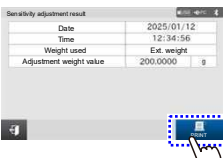
- The accuracy of the weight used in sensitivity adjustment affects the accuracy of the balance after sensitivity adjustment.

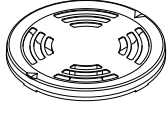
10.2.1. Procedure for external sensitivity adjustment

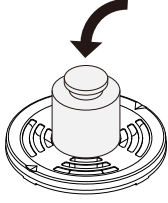
Example: Weighing with BH-324TE

Step	Description	Display and key operations	Weighing operation
1	<p>Make sure that nothing is on the weighing pan and press the [Confirm] button .</p> <p>The balance measures the zero point.</p> <p>Do not apply vibration and the like to the balance.</p> <p>Note: You can input the external weight value before input.</p>		 <p>Weighing pan</p>
2	<p>Place the weight on the weighing pan and press the [Confirm] button .</p> <p>Measure the weight.</p> <p>Do not apply vibration and the like to the balance.</p> <p>Note: You can input the external weight value before input.</p>		 <p>Weight</p>
3	<p>The [Sensitivity adjustment result] screen for the external sensitivity adjustment is automatically displayed. Please remove the weight.</p>		
4	<p>You can output the result by pressing the [PRINT] button .</p> <p>Note: The result is automatically output if either [GLP output] or [GLP custom output] is set for [GLP output/Label output].</p>	<p>Result display</p>  <p>GLP output </p>	
5	<p>Press the [HOME] key  to return to the weighing screen.</p> <p>Place the weight again to confirm that the sensitivity of the balance is adjusted properly.</p> <p>If it is not within the range, start over from the first step of this procedure in the appropriate ambient conditions.</p>		

10.3. Automatic sensitivity adjustment

Display settings: [MENU] key  > [Sensitivity adjustment] button  > [Automatic sensitivity adjustment] button  > [Automatic sensitivity adjustment] settings screen.

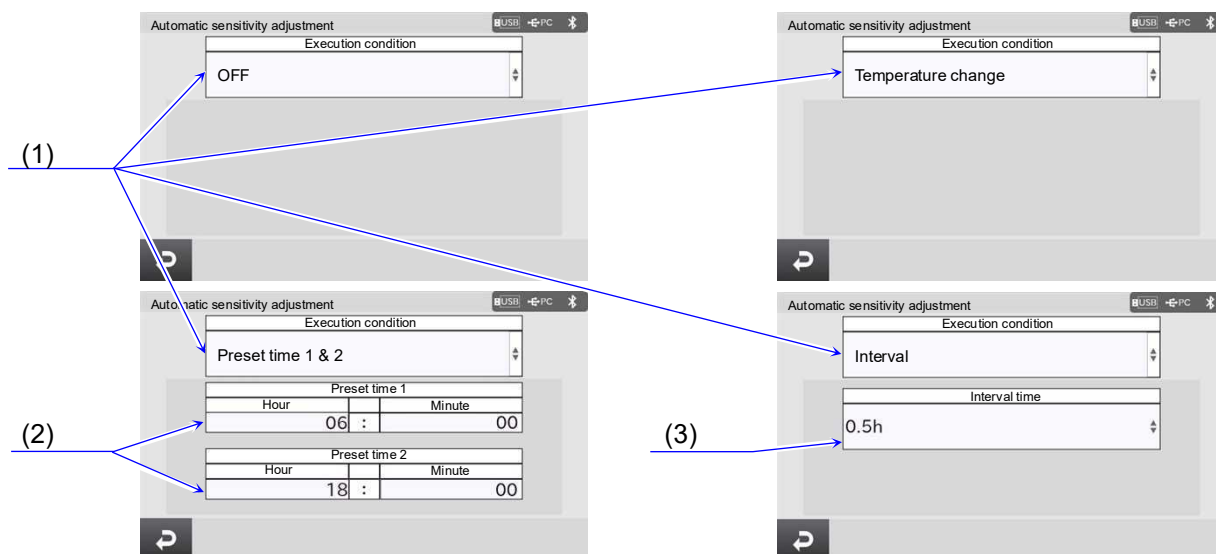

	Name	Setting value (setting range)	Description
(1)	Automatic sensitivity adjustment execution condition setting field	OFF, Temperature change , Preset time 1, Preset time 1&2, Interval	Set the automatic sensitivity adjustment execution condition. If you select the preset time or interval, the relevant time setting is displayed below the setting field.
(2)	Automatic sensitivity adjustment time setting	0:00 to 24:00	Set the automatic sensitivity adjustment start time.
(3)	Automatic sensitivity adjustment interval setting	0.5 , 1.0, 1.5, 2.0, 2.5, 3.0, 3.5, 4.0, 4.5, 5.0, 5.5, 6.0, 7.0, 8.0, 9.0, 10.0, 11.0, 12.0, 14.0, 16.0, 18.0, 20.0, 22.0, 24.0	Set the automatic sensitivity adjustment interval.

Settings in the red box are default values (factory settings).

This function automatically adjusts the sensitivity of the balance according to ambient temperature change, set time or interval time using the internal weight. It works even when the display is off. The sensitivity adjustment report is output after the sensitivity adjustment if either [GLP output] or [GLP custom output] is set for [GLP output/Label output] ("[13.13. GLP output](#)").

- The execution condition for the automatic sensitivity adjustment can be based on the temperature change, preset time or interval.
- For preset time, you can configure two settings: "Preset time 1" and "Preset time 2".
- For the interval, you can set a value between 0.5 h and 24.0 h.

CAUTION



- ❑ If something is on the weighing pan, the balance itself will judge that it is in use and will not perform automatic sensitivity adjustment.

The criteria for performing automatic sensitivity adjustment are as follows.

BH-225TE / BH-225DTE BH-324TE / BH-224TE	Less than 0.5 g
---	-----------------

- ❑ To maintain the correct sensitivity adjustment of the balance, do not place anything on the weighing pan while not in use.

10.4. Sensitivity adjustment setting

Display settings: [MENU] key  > [Sensitivity adjustment] button  > [Settings] button  > [Sensitivity adjustment setting] screen.

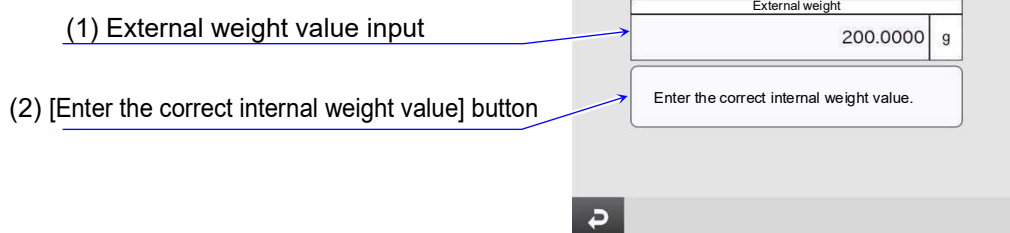



	Name	Setting value (setting range)	Description
(1)	External weight value input	Input range*1	Input the external weight value. This is common to the "Adjustment weight value" input item in the [External sensitivity adjustment] screen (" 10.2. External sensitivity adjustment ").
(2)	[Enter the correct internal weight value] button	-	Displays the [Internal sensitivity adjustment] screen (" 10.1. Internal sensitivity adjustment ").

 Settings in the red box are default values (factory settings).

*1 Input range

BH-225TE / BH-225DTE: 9.9 g to 200 g to 200.1 g
 BH-324TE: 9.9 g to 200 g to 300.1 g
 BH-224TE: 9.9 g to 200 g to 200.1 g

10.5. Correcting the internal weight value

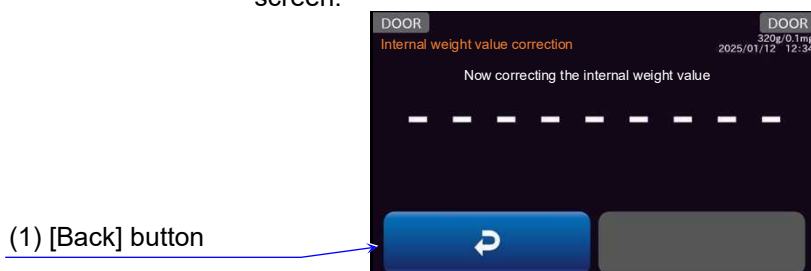

Display settings: [MENU] key  > [Sensitivity adjustment] button  > [Settings] button  > [Enter the correct internal weight value] button > [Internal sensitivity adjustment] screen.



	Name	Description
(1)	[Back] button	Returns to the previous screen.

- This function corrects the internal weight value based on an external weight. Execute the external sensitivity adjustment in advance ("[10.2. External sensitivity adjustment](#)"). The balance automatically loads and unloads the internal weight and corrects the internal weight value. Then the balance automatically executes the internal sensitivity adjustment. When the adjustment is complete, the [Sensitivity adjustment setting] screen is displayed ("[10.4. Sensitivity adjustment setting](#)"). The corrected value is stored in nonvolatile memory even if the AC adapter is removed.

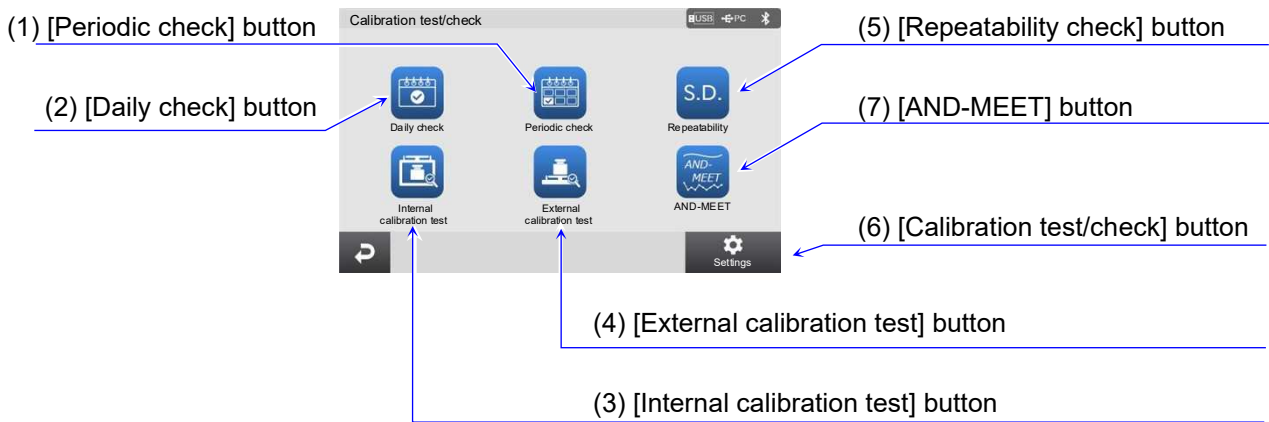

11. Calibration Test/Check

Display settings: [MENU] key  > [Calibration test/check] button  > [Calibration test/check] screen.



	Name	Description
(1)	[Periodic check] button	Executes the periodic check ("11.2. Periodic check").
(2)	[Daily check] button	Executes the daily check ("11.1. Daily check").
(3)	[Internal calibration test] button	Executes the internal calibration test ("11.4. Internal calibration test").
(4)	[External calibration test] button	Executes the external calibration test ("11.5. External calibration test").
(5)	[Repeatability check] button	Displays the [Repeatability measurement] screen for check ("11.3. Repeatability check").
(6)	[Calibration test/check] button	Displays the [Calibration test/check] settings screen.
(7)	[AND-MEET] button	Displays the [AND-MEET] screen ("11.6. AND-MEET").

11.1. Daily check

Display settings: [MENU] key  > [Calibration test/check] button  > [Daily check] button  > [Daily check] screen, [Environmental conditions] screen (From this screen, display check items in sequence).

Daily check details

During daily check, you check the minimum required items for using the balance to make sure that there is no serious error with the balance. It is advisable to perform this check every day before work, though this may depend on the maintenance level of the balance.

1. Environmental conditions

- ❑ Make sure that the operating temperature and humidity of the balance fall within the "26.1. Common specifications".

If the humidity is 45 %RH or less, it is recommended that static elimination be performed before weighing.

- ❑ Be sure to warm up the balance for at least an hour before use.

The warm-up time is the period of time when the power to the balance is on before use.

Note: You can measure up to 9999 hours for the warm-up time.

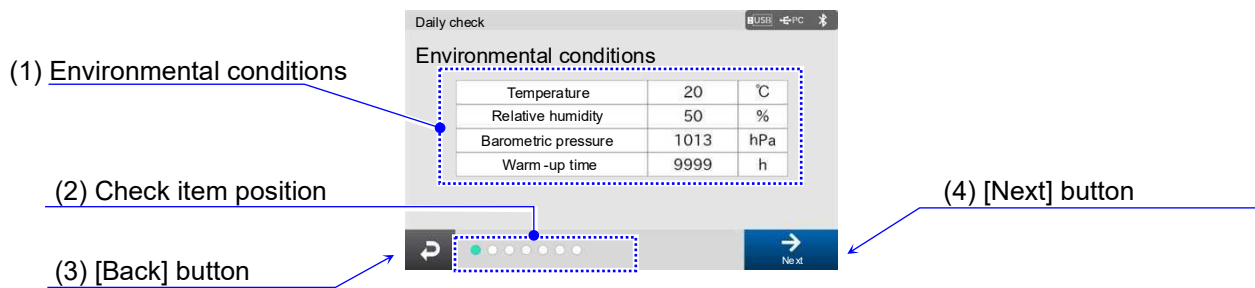

	Name	Description
(1)	Environmental conditions	Displays the environmental conditions.
(2)	Check item position	Displays the position of the current check item.
(3)	[Back] button	Returns to the [Calibration test/check] screen ("11. Calibration Test/Check").
(4)	[Next] button	Considers this check item as OK and proceeds to the next item.

2. Balance handling level

□ Check the balance handling level.

The balance handling level is calculated based on the following data.

- The number of times the balance has detected an impact since the last periodic check
- Impact level detected by the balance

	Balance handling level	Description
Good ↕	A	No potentially damaging impact on the balance has been detected. The balance has been used without any problems.
	B	Several potentially damaging impacts on the balance have been detected. Please take care when placing an object on the balance.
Bad	C	Many potentially damaging impacts on the balance have been detected. It is advised to carry out periodic check of the balance.

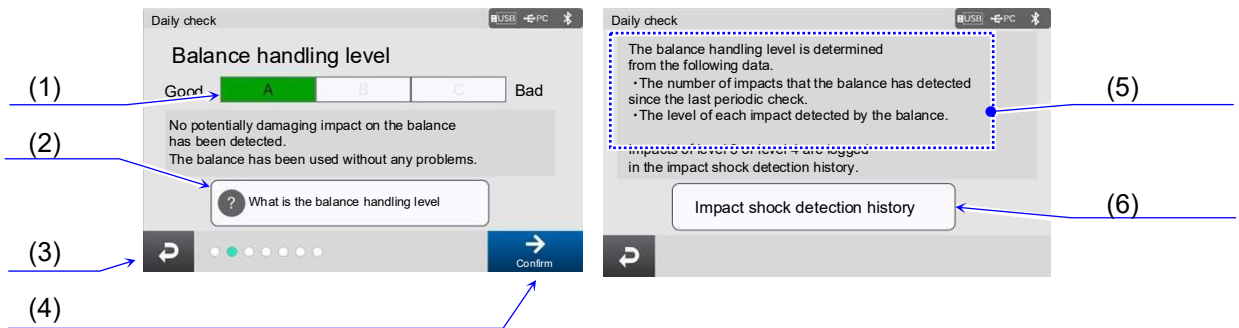

	Name	Description
(1)	Balance handling level	Displays the level of balance handling.
(2)	[Explanation of Balance handling level] button	Displays the screen for explaining balance handling level.
(3)	[Back] button	Returns to the previous screen.
(4)	[Confirm] button	Considers this check item as OK and proceeds to the next item.
(5)	Explanation of balance handling level	Balance handling level is explained.
(6)	[Impact shock detection history] button	Displays the [Impact shock detection history] screen (" 13.32. Impact shock detection history ").

3. External condition check

- ❑ Make sure that the area around the weighing pan in the breeze break is clean.
If it is dirty, clean it. Contamination may result.
- ❑ Make sure that the balance body is not damaged or deformed.
Damage or deformation may result in malfunction of the balance or injury to users.

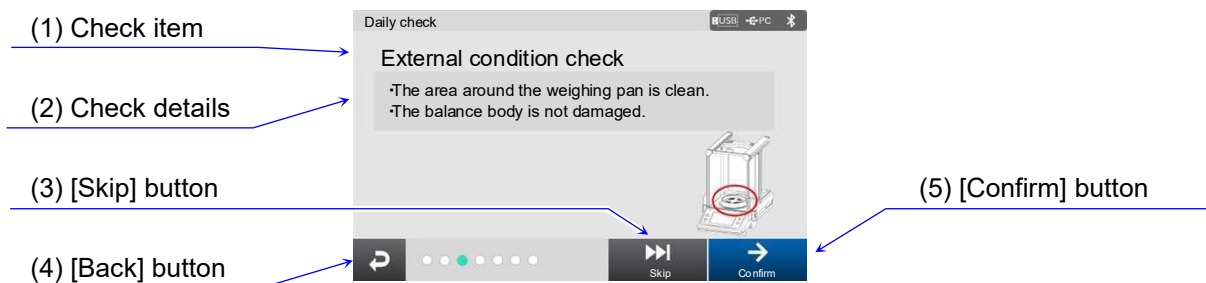

	Name	Description
(1)	Check item	Displays check items.
(2)	Check details	Displays check details.
(3)	[Skip] button	Skips this check item and proceeds to the next item.
(4)	[Back] button	Returns to the previous screen.
(5)	[Confirm] button	Considers this check item as OK and proceeds to the next item.

4. Level check

- ❑ Make sure that the air bubble on the spirit level is in the center of the circle. If it is not in the center, accurate weighing is not possible.
- ❑ Refer to the leveling method and rotate the leveling feet to adjust the level of the balance. The leveling method is the same as with the periodic check.

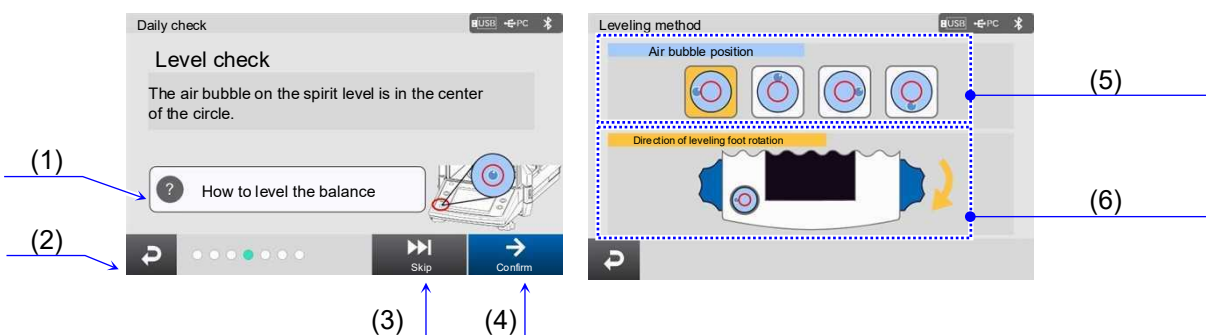

	Name	Description
(1)	[Leveling method] button	Displays the [Leveling method] screen.
(2)	[Back] button	Returns to the previous screen.
(3)	[Skip] button	Skips this check item and proceeds to the next item.
(4)	[Confirm] button	Considers this check item as OK and proceeds to the next item.
(5)	[Air bubble position] button	Touch the current air bubble position.
(6)	Direction of leveling foot rotation	Displays the direction of rotating the leveling foot in order to adjust the level of the balance. Images depend on the air bubble position.

5. Weighing pan check

- Make sure that there is nothing on the weighing pan.

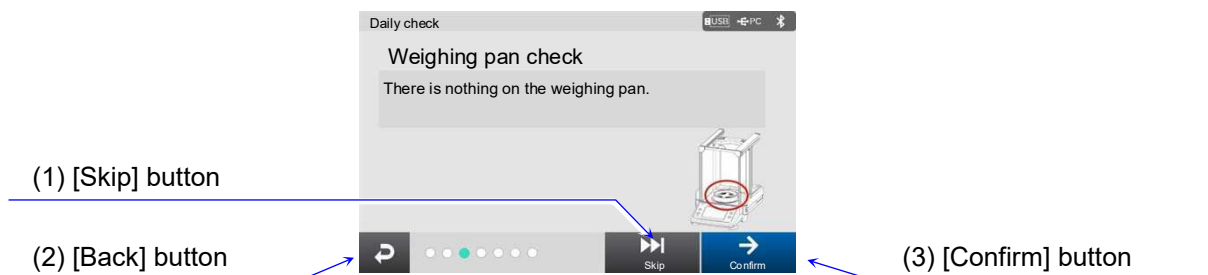

	Name	Description
(1)	[Skip] button	Skips this check item and proceeds to the next item.
(2)	[Back] button	Returns to the previous screen.
(3)	[Confirm] button	Considers this check item as OK and proceeds to the next item.

6. Accuracy check

- Use your test weight to make sure that the deviation falls within the tolerance.

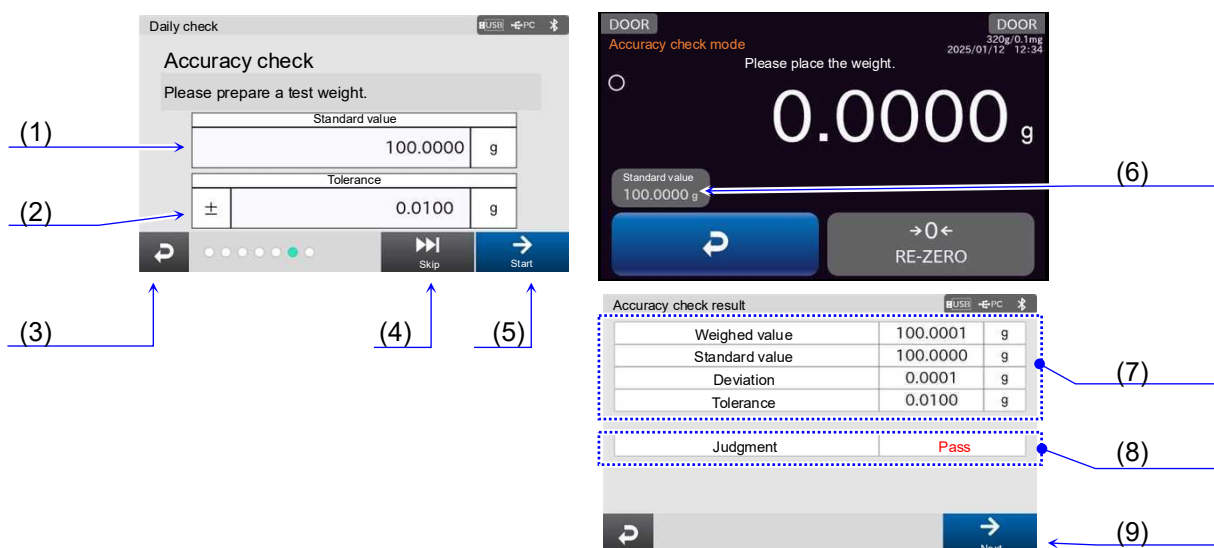

	Name	Description
(1)	Test weight value input field	Input the value for your test weight.
(2)	Tolerance input field	Input the tolerance.
(3)	[Back] button	Returns to the previous screen.
(4)	[Skip] button	Skips this check item and proceeds to the next item.
(5)	Accuracy check [Start] button	Displays the [Accuracy check mode] screen.
(6)	Test weight value input field	Input the value for your test weight. This is common to the one in the [Accuracy check] screen.
(7)	Accuracy check result display	Displays the accuracy check result.
(8)	Judgment	Displays the judgment.
(9)	[Next] button	Proceeds to the next check item.

7. Daily check results

- The results of all daily check items are displayed.

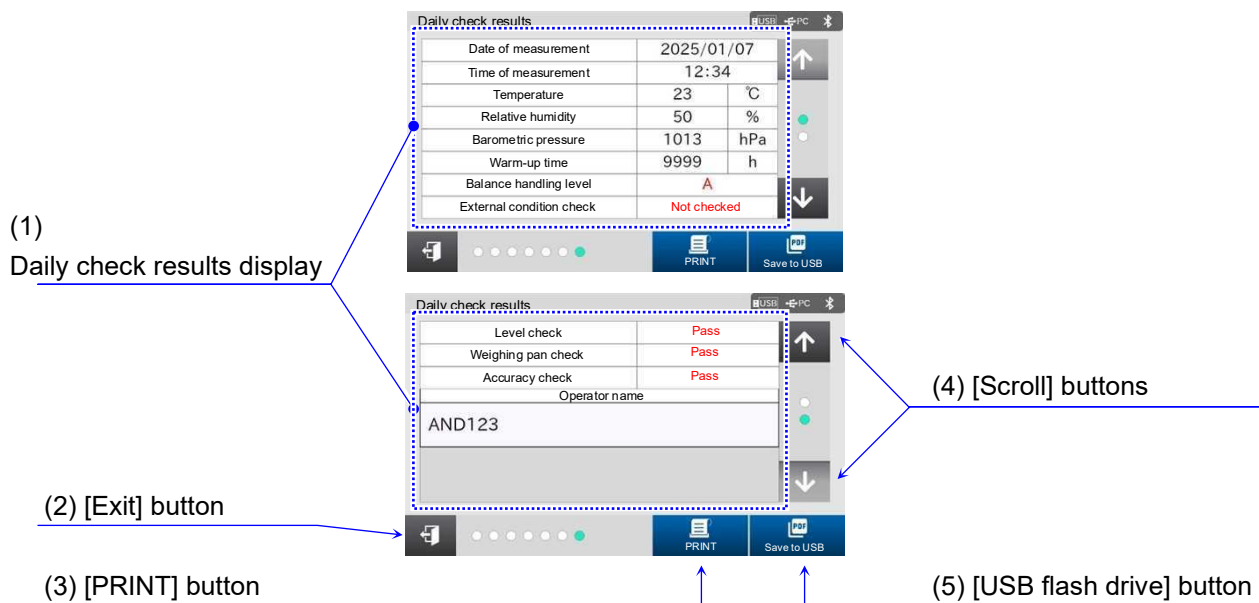

	Name	Description
(1)	Daily check results display	Shows the results of the daily check.
(2)	[Exit] button	Exits the daily check and displays the [Calibration test/check] screen ("11. Calibration Test/Check").
(3)	[PRINT] button	Outputs the daily check results to the device connected to the balance.
(4)	[Scroll] buttons	Select the page.
(5)	[USB flash drive] button	Outputs PDF data containing the daily check results to the USB flash drive connected to the balance.

11.1.1. Output example for daily check output results

Daily check output results

```
---DAILY CHECK---  
  
          A & D  
MODEL    BH-324TE  
S/N      T2400000  
ID LAB-012345678  
DATE     2025/04/03  
TIME     12:16:08  
  
TEMP     26 C  
RH       40 %  
BAR      1014hPa  
WARM UP  1 h  
  
HANDLING LEVEL  
          A  
EXT. CONDITION  
          MET  
LEVEL CHECK  
          MET  
WEIGHING PAN  
          MET  
  
WEIGHT CHECK  
SETTING  
  100.0000 g  
MEASURED  
  100.0000 g  
SPEC.    0.0005 g  
JUDGEMENT MET  
  
REMARKS  
  
SIGNATURE  
  
-----
```

Daily check PDF results

Daily Balance Check Report



Date : 2025/04/03 12:16:08

Location : a&d

Weight used :

1. Balance

Model : BH-324TE Capacity : 320g Readability : 0.1mg

Serial No. : T2400000 ID No. : LAB-012345678

2. Environmental conditions

Temperature : 26 C Relative humidity : 40 %

Barometric Pressure : 1014 hPa Warm-up time : 1 h

3. Check items

3-1. Balance handling level

Good

A		
---	--	--

 Bad

3-2. External condition check

The area around the weighing pan is clean : Pass

The balance body is not damaged : Pass

3-3. Level check

The air bubble on the spirit level is
in the center of the circle : Pass

3-4. Weighing pan check

There is nothing on the weighing pan : Pass

3-5. Accuracy check : Pass



Std value	100.0000 g	Weighed value	100.0000 g
Deviation	0.0000 g	Judgment	0.0005 g

4. Remarks

Signature (Operator) _____

Signature (Manager) _____

11.2. Periodic check

Display settings: [MENU] key  > [Calibration test/check] button  > [Periodic check] button  > [Periodic check] screen, [Environmental conditions] screen (From this screen, display check items in sequence).

Periodic check details

During the periodic check, a weight is used to check basic properties of the balance including the repeatability, linearity and eccentricity and manage how weighing values perform against the specifications. It is advisable to perform this check once per week or month, though this may depend on the maintenance level of the balance.

1. Environmental conditions

- ❑ Make sure that the operating temperature and humidity of the balance fall within the specifications. If the humidity is 45 %RH or less, it is recommended that static elimination be performed before weighing.
- ❑ Be sure to warm up the balance for at least an hour before use. The warm-up time is the period of time when the power to the balance is on before use.
Note: You can measure up to 9999 hours for the warm-up time.

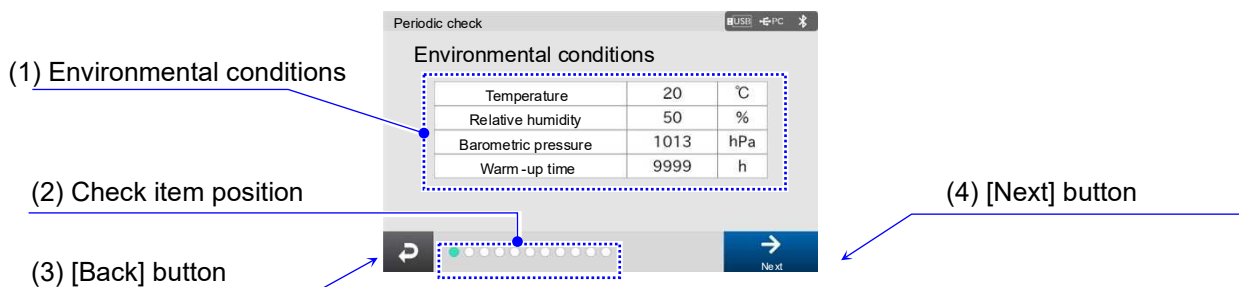

	Name	Description
(1)	Environmental conditions	Displays the environmental conditions.
(2)	Check item position	Displays the position of the current check item.
(3)	[Back] button	Returns to the [Calibration test/check] screen ("11. Calibration Test/Check").
(4)	[Next] button	Considers this check item as OK and proceeds to the next item.

2. External condition check

- ❑ Make sure that the area around the weighing pan in the breeze break is clean.
If it is dirty, clean it. Contamination may result.
- ❑ Make sure that the balance body is not damaged or deformed.
Damage or deformation may result in malfunction of the balance or injury to users.

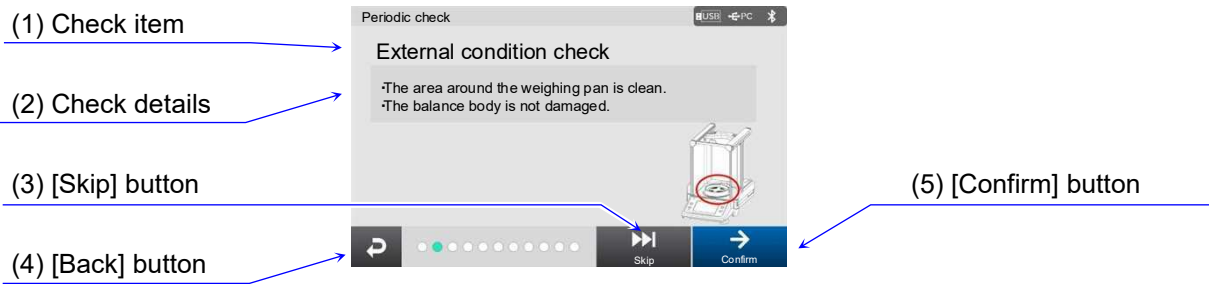

	Name	Description
(1)	Check item	Displays check items.
(2)	Check details	Displays check details.
(3)	[Skip] button	Skips this check item and proceeds to the next item.
(4)	[Back] button	Returns to the previous screen.
(5)	[Confirm] button	Considers this check item as OK and proceeds to the next item.

3. Level check

- ❑ Make sure that the air bubble on the spirit level is in the center of the circle. If it is not in the center, accurate weighing is not possible.
- ❑ Refer to the leveling method and rotate the leveling feet to adjust the level of the balance. The leveling method is the same as with the daily check.

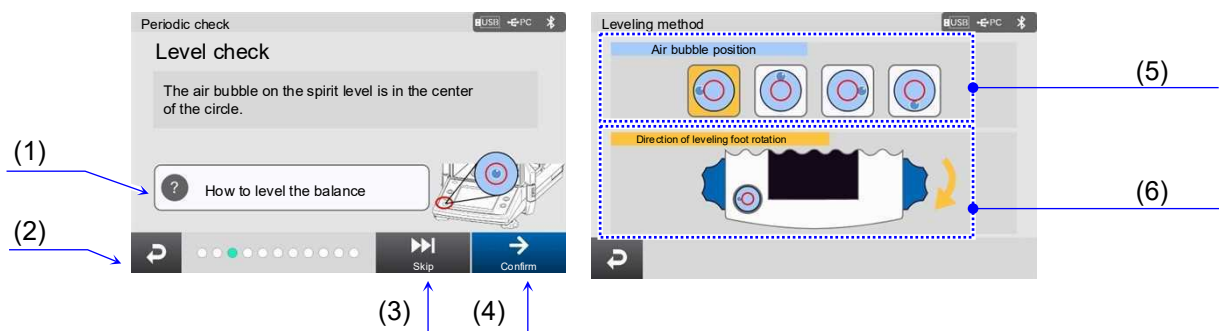

	Name	Description
(1)	[Leveling method] button	Displays the [Leveling method] screen.
(2)	[Back] button	Returns to the previous screen.
(3)	[Skip] button	Skips this check item and proceeds to the next item.
(4)	[Confirm] button	Considers this check item as OK and proceeds to the next item.
(5)	[Air bubble position] button	Touch the current air bubble position.
(6)	Direction of leveling foot rotation	Displays the direction of rotating the leveling foot in order to adjust the level of the balance. Images depend on the air bubble position.

4. Weighing pan check

- ❑ Make sure that there is nothing on the weighing pan.

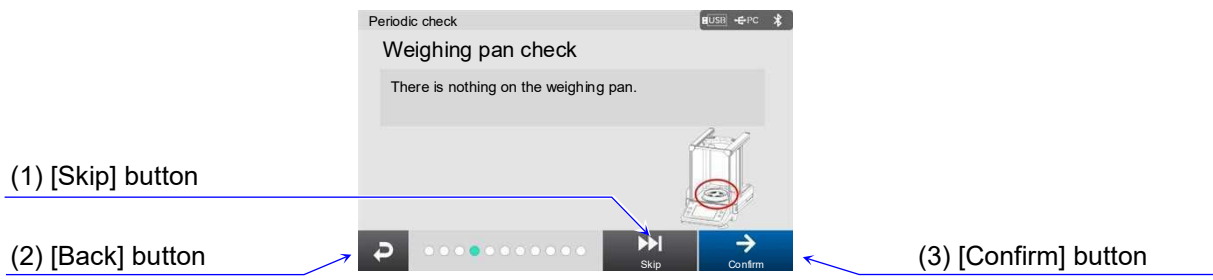

	Name	Description
(1)	[Skip] button	Skips this check item and proceeds to the next item.
(2)	[Back] button	Returns to the previous screen.
(3)	[Confirm] button	Considers this check item as OK and proceeds to the next item.

5. Calibration test (before sensitivity adjustment)

- The calibration test is performed before sensitivity adjustment.

When the test is completed, the [Calibration test result] screen is displayed.

- When the internal weight is used, this is automatically performed. When an external weight is used, follow the instruction.

Do not apply vibration and the like to the balance during the calibration test.

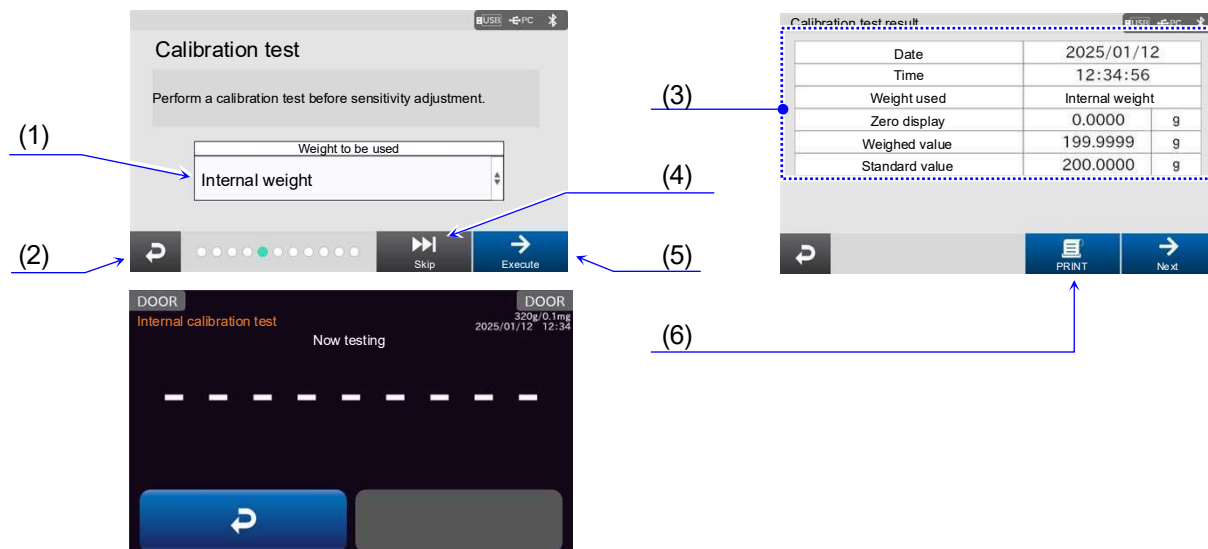

	Name	Setting value (setting range)	Description
(1)	Weight to be used	Internal weight, External weight	Select the weight to be used.
(2)	[Back] button	-	Cancels and returns to the previous screen.
(3)	Result display	-	Displays the calibration test result.
(4)	[Skip] button	-	Skips this check item and proceeds to the next item.
(5)	[Execute] button	-	Executes the calibration test.
(6)	[PRINT] button		Outputs the results to the device connected to the balance. The results are automatically output if [GLP output] in [Data output] is set to ON.*

Internal weight Settings in the red box are default values (factory settings).

- * It is automatically output if either [GLP output] or [GLP custom output] is set for [GLP output/Label output].

6. Sensitivity adjustment

The sensitivity adjustment is performed. When the adjustment is complete, the [Sensitivity adjustment result] screen is automatically displayed.

Be sure to warm up the balance with nothing on the weighing pan for at least an hour.

When the internal weight is used, this is automatically performed. When an external weight is used, follow the instruction.

Do not apply vibration and the like to the balance during sensitivity adjustment.

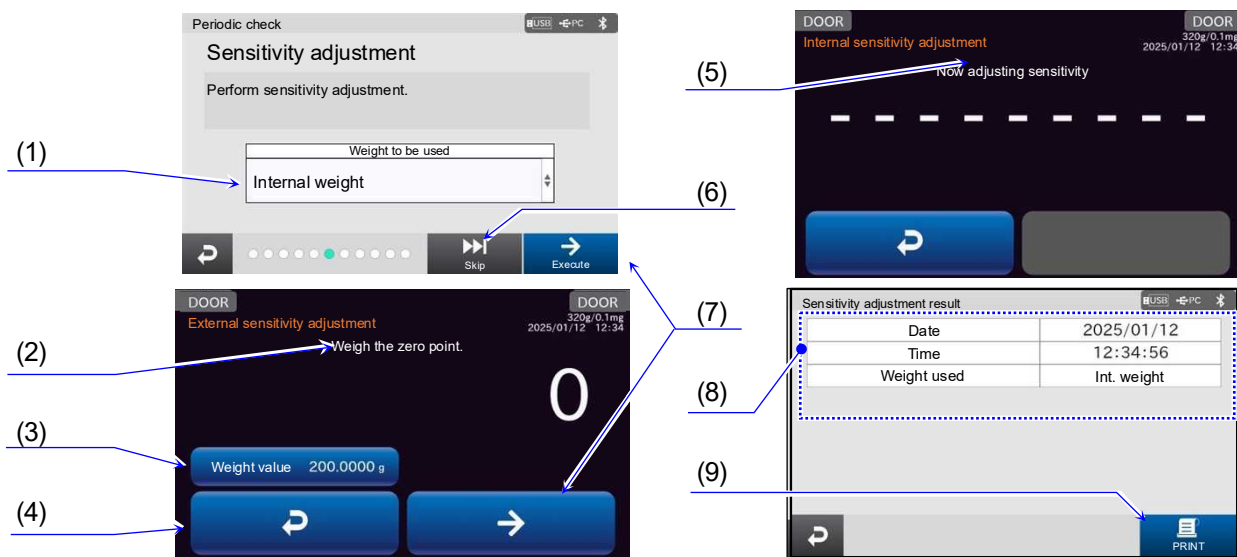

	Name	Setting value (setting range)	Description
(1)	Weight to be used	Internal weight External weight	Select the weight to be used.
(2)	Instruction display	-	Displays the instruction for external sensitivity adjustment.
(3)	External weight value input	Input range*1	Input the external weight value. This is common to the external weight value input field in the [Sensitivity adjustment setting] screen ("10. [Sensitivity Adjustment] Screen").
(4)	[Back] button	-	Cancels and returns to the previous screen.
(5)	Instruction display	-	Displays the progress of the internal sensitivity adjustment.
(6)	[Skip] button	-	Skips this check item and proceeds to the next item.
(7)	[Execute] button	-	Executes the sensitivity adjustment.
(8)	Result display	-	Displays the sensitivity adjustment result.
(9)	[PRINT] button		Outputs the results to the device connected to the balance.*2

Internal weight Settings in the red box are default values (factory settings).

***1** Input range

BH-225TE / BH-225DTE: 9.9 g to 200 g to 200.1 g

BH-324TE: 9.9 g to 200 g to 300.1 g

BH-224TE: 9.9 g to 200 g to 200.1 g

***2** It is automatically output if either [GLP output] or [GLP custom output] is set for [GLP output/Label output].

7. Pre-loading

Select the weight to be used for execution.

For the internal weight, the pre-loading is automatically performed.

For an external weight, the instruction is displayed on the screen.

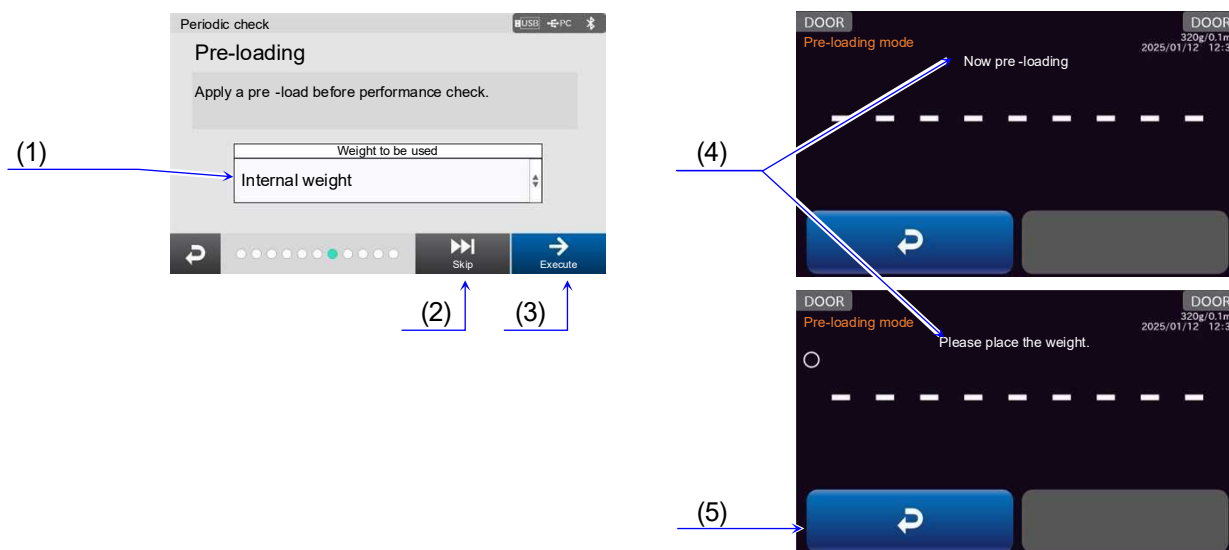

	Name	Setting value (setting range)	Description
(1)	Weight to be used	Internal weight, External weight	Select the weight to be used.
(2)	[Skip] button	-	Skips this check item and proceeds to the next item.
(3)	[Execute] button	-	Executes the pre-loading.
(4)	Instruction display	-	Displays the progress and instruction.
(5)	[Back] button	-	Returns to the previous screen.

Internal weight Settings in the red box are default values (factory settings).

8. Repeatability

Load and unload the weight multiple times to obtain the standard deviation.

Follow the instruction to load and unload the weight as many times as the specified measurement count.

The setting in the [Repeatability] screen is common to the standard value setting for the daily/periodic check settings.

When the measurement is complete, the [Repeatability measurement result] screen is automatically displayed.

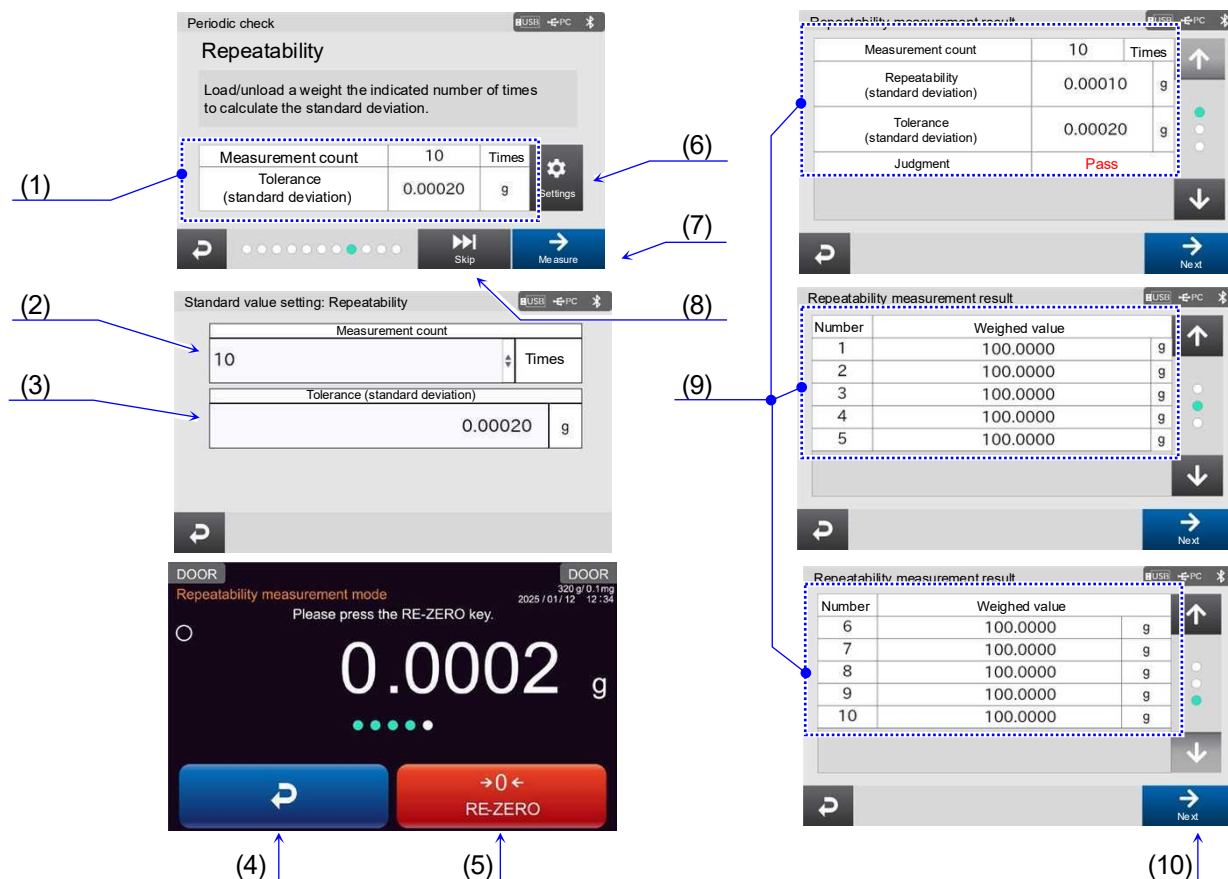

	Name	Description
(1)	Settings display screen	Displays the set measurement count and tolerance (standard deviation).
(2)	Measurement count	Set the measurement count. This is common to " 11.9.1. Standard value setting: Repeatability ".
(3)	Tolerance (standard deviation)	Set the tolerance (standard deviation). This is common to " 11.9.1. Standard value setting: Repeatability ".
(4)	[Back] button	Cancels and returns to the previous screen.
(5)	[RE-ZERO] button	Sets the displayed value to zero.
(6)	[Settings] button	Displays the [Standard value setting] screen. Refer to " 11.9. Standard value setting ". Set the measurement count and tolerance (standard deviation).
(7)	[Measure] button	Executes the measurement.
(8)	[Skip] button	Skips this check item and proceeds to the next item.
(9)	Repeatability measurement result display	Repeatability measurement result display
(10)	[Next] button	Proceeds to the next item.

9. Sensitivity test

The sensitivity test is performed with the selected loading points.

Follow the instruction for measurement operations.

The setting in the [Sensitivity test] screen is common to the standard value setting for the daily/periodic check settings.

When the test is complete, the [Sensitivity test result] screen is automatically displayed.

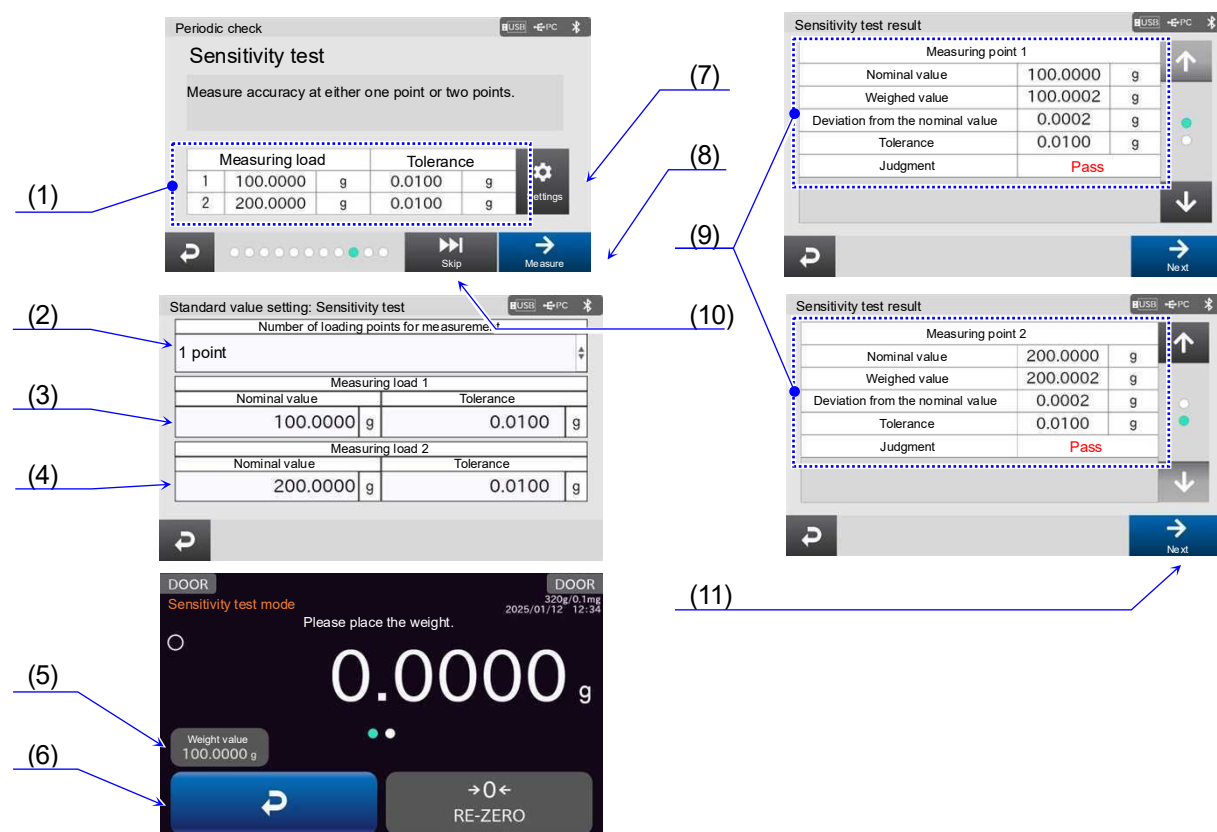

	Name	Setting value (setting range)	Description
(1)	Settings display screen	-	Displays the set tolerance.
(2)	Number of loading points for measurement	1 point, 2 points	You can select the number of loading points for measurement.
(3)	Measuring load 1	-	Displays the nominal value and tolerance.
(4)	Measuring load 2	-	Displays the nominal value and tolerance.
(5)	Measuring load display	-	Displays the measuring load.
(6)	[Back] button	-	Cancels and returns to the previous screen.
(7)	[Settings] button	-	Displays the [Standard value setting] screen. Set the measurement count and tolerance (standard deviation).
(8)	[Measure] button	-	Executes the measurement.
(9)	Sensitivity test result display	-	Displays the sensitivity test result.
(10)	[Skip] button	-	Skips this check item and proceeds to the next item.
(11)	[Next] button	-	Proceeds to the next item.

1 point Settings in the red box are default values (factory settings).

10. Eccentricity

The eccentricity is measured.

Follow the instruction for measurement.

The setting in the [Sensitivity test] screen is common to the standard value setting for the daily/periodic check settings.

When the measurement is complete, the [Eccentricity measurement result] screen is automatically displayed.

The accurate positions for measurement positions 2, 3, 4 and 5 are at the 1/4 position of the diagonal line or diameter of the weighing pan.

It is advisable to use a weight approx. 1/3 as heavy as the capacity of the balance.

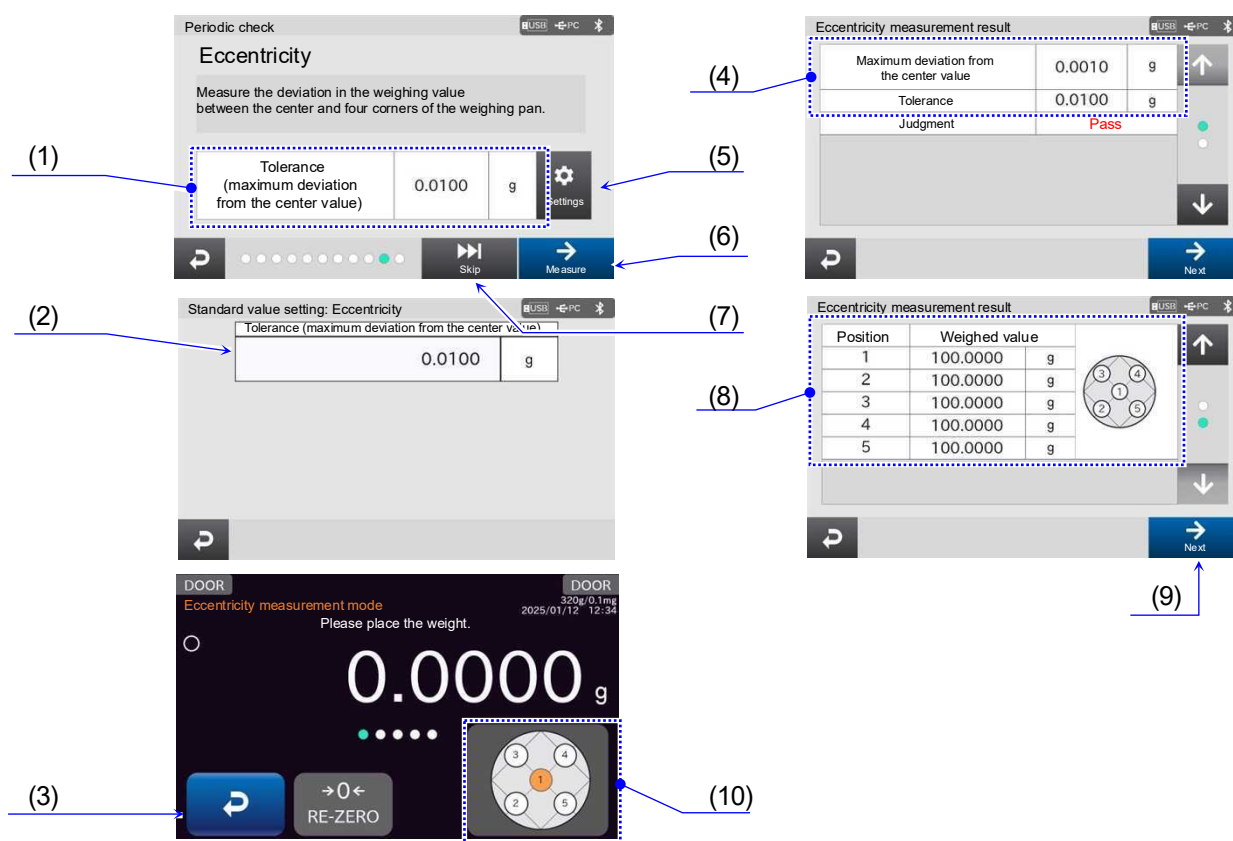

	Name	Description
(1)	Settings display screen	Displays the set tolerance (maximum deviation from the center value).
(2)	Tolerance (maximum deviation from the center value)	Set the tolerance for eccentricity.
(3)	[Back] button	Cancels and returns to the previous screen.
(4)	Eccentricity measurement result display	Cancels the eccentricity measurement and returns to the previous screen.
(5)	[Settings] button	Displays the [Standard value setting] screen. Configure the set tolerance (maximum deviation from the center value).
(6)	[Measure] button	Executes the measurement.
(7)	[Skip] button	Skips this check item and proceeds to the next item.
(8)	Weighing value	Displays the measurement positions and weighing values.
(9)	[Next] button	Proceeds to the next item.
(10)	Weight position image	Displays the positions where the weight is placed during measurement.

11. Periodic check results

The results of all periodic check items are displayed.

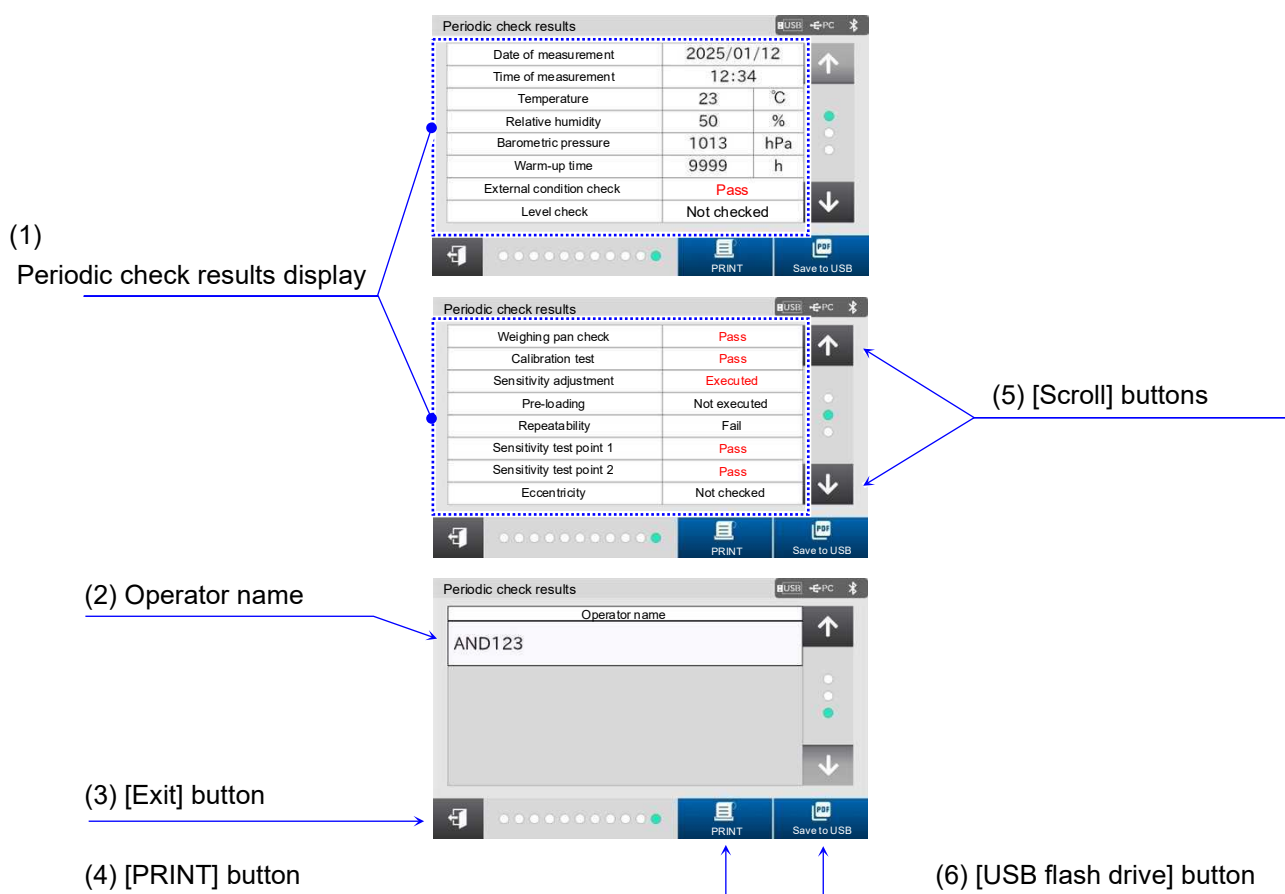

	Name	Description
(1)	Periodic check results display	Shows the results of the periodic check.
(2)	Operator name	Input the name of user who operates the periodic check.
(3)	[Exit] button	Exits the screen that shows the periodic check results.
(4)	[PRINT] button	Outputs the periodic check results to the device connected to the balance.
(5)	[Scroll] buttons	Select the page.
(6)	[USB flash drive] button	Outputs PDF data containing the periodic check results to the USB flash drive connected to the balance.

11.2.1. Output example for periodic check output results

Periodic check output results

```
-PERIODIC CHECK-

      A & D
MODEL   BH-324TE
S/N     T24000000
ID LAB-012345678
DATE    2025/04/03
TIME    12:27:11

TEMP     26 C
RH       40 %
BAR      1013hPa
WARM UP  1 h

EXT. CONDITION
      MET
LEVEL CHECK
      MET
WEIGHING PAN
      MET

CAL.TEST(INT.)
ACTUAL   0.0000 g
        +199.9999 g
TARGET  +200.0000 g

ADJUSTED(INT.)

PRELOAD  MET

REPEATABILITY
 1  100.0002 g
 2  100.0002 g
 3  100.0001 g
 4  100.0001 g
 5  100.0001 g
 6  100.0001 g
 7  100.0001 g
 8  100.0001 g
 9  100.0002 g
10  100.0001 g

SD      0.00005 g
SPEC.   0.00010 g
JUDGEMENT MET

SENSITIVITY TEST

      SENSITIVITY TEST
SETTING  100.0000 g
MEASURED 100.0002 g
SPEC.    0.0010 g
JUDGEMENT MET

SETTING  - - - - - g
MEASURED - - - - - g
SPEC.    - - - - - g
JUDGEMENT **

ECCENTRICITY ERR
 1  100.0001 g
 2  100.0002 g
 3  100.0001 g
 4  100.0002 g
 5  100.0003 g

MAX. DIFFERENCE
      0.0002 g
SPEC.    0.0010 g
JUDGEMENT MET

REMARKS

SIGNATURE
-----
```

Periodic check results (PDF)

Periodic Balance Check Report



Date : 2025/04/03 12:27:11 Last check date: - - - - -
 Location : a&d
 Weight used :

1. Balance

Model : BH-324TE Capacity : 320g Readability : 0.1mg
 Serial No. : T2400000 ID No. : LAB-012345678

2. Environmental conditions

Temperature : 26 C Relative humidity : 40 %
 Barometric Pressure : 1013 hPa Warm-up time : 1 h

3. Check items

3-1. Ext. condition check : Pass 3-2. Level check : Pass
 3-3. Weighing pan check : Pass

4. Performance check

4-1. Calibration test : Pass

Weight used	Int. weight	Std value	+200.0000 g	Weighed value	+199.9999 g
-------------	-------------	-----------	-------------	---------------	-------------

4-2. Sensitivity adjustment : Pass

Weight used	Int. weight	Std value	- - - - - g
-------------	-------------	-----------	-------------

4-3. Pre-loading : Executed

4-4. Repeatability : Pass

No.	1	2	3	4	5
Weighed value	100.0002 g	100.0002 g	100.0001 g	100.0001 g	100.0001 g
No.	6	7	8	9	10
Weighed value	100.0001 g	100.0001 g	100.0001 g	100.0002 g	100.0001 g
Std deviation	0.00005 g	Judgment	0.00010 g		

4-5. Sensitivity test Point 1 : Pass Point 2 : Not checked

Point	Nominal value	Weighed value	Deviation	Judgment
1	100.0000 g	100.0002 g	0.0002 g	0.0010 g
2	- - - - - g	- - - - - g	- - - - - g	- - - - - g

4-6. Eccentricity : Pass

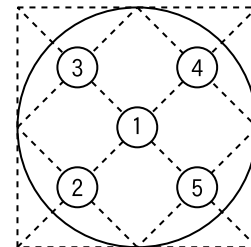

Position	1	2	3
Weighed value	100.0001 g	100.0002 g	100.0001 g
Position	4	5	
Weighed value	100.0002 g	100.0003 g	
Max deviation from center	0.0002 g	Judgment	0.0010 g



5. Remarks

Signature (Operator) _____
 Signature (Manager) _____

11.3. Repeatability check

Display settings: [MENU] key  > [Calibration test/check] button > [Repeatability check] button  > [Repeatability measurement] screen.

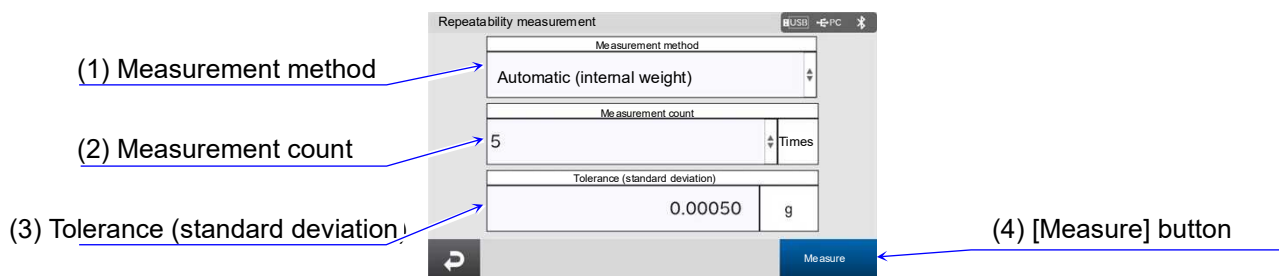





	Name	Setting value (setting range)	Description
(1)	Measurement method	Automatic (internal weight), Manual (external weight)	Select the measurement method.
(2)	Measurement count	-	Displays the measurement count.
(3)	Tolerance (standard deviation)	-	Displays the tolerance (standard deviation).
(4)	[Measure] button	-	Executes the measurement.
(5)	[Back] button	-	Returns to the previous screen.

 Settings in the red box are default values (factory settings).

- ❑ For the internal weight, the repeatability check is automatically performed.
For an external weight, follow the instruction.
When the measurement is complete, the [Repeatability measurement result] screen is automatically displayed.
- ❑ This is common to the [Quick performance check: Repeatability measurement] screen described in "6. Quick Performance Check: [Repeatability Measurement] Screen".



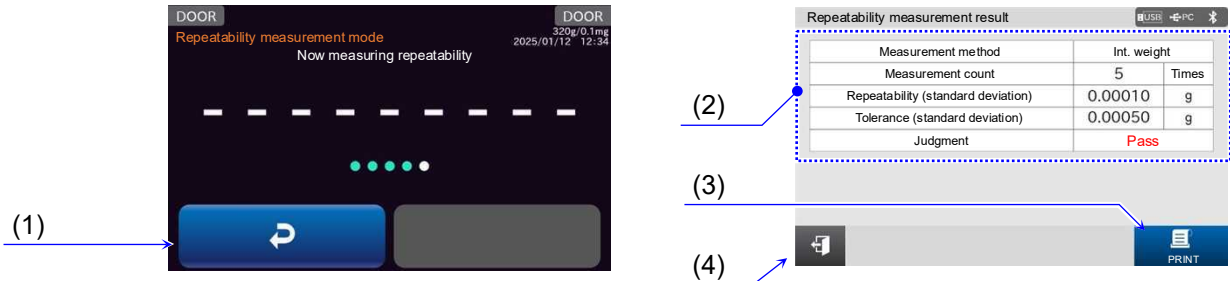

11.3.1. Repeatability measurement with the internal weight

Display settings: [MENU] key  > [Calibration test/check] button  > [Repeatability check] button  > [Repeatability measurement] screen. In this screen, with [Automatic (internal weight)] selected for the measurement method, select [Measure] button  > [Repeatability measurement] screen with the internal weight.



	Name	Description
(1)	[Back] button	Returns to the previous screen.
(2)	Repeatability measurement result display	Repeatability measurement result display
(3)	[PRINT] button	Outputs the result to the device connected to the balance.
(4)	[Exit] button	Exits the screen that shows the repeatability measurement result.

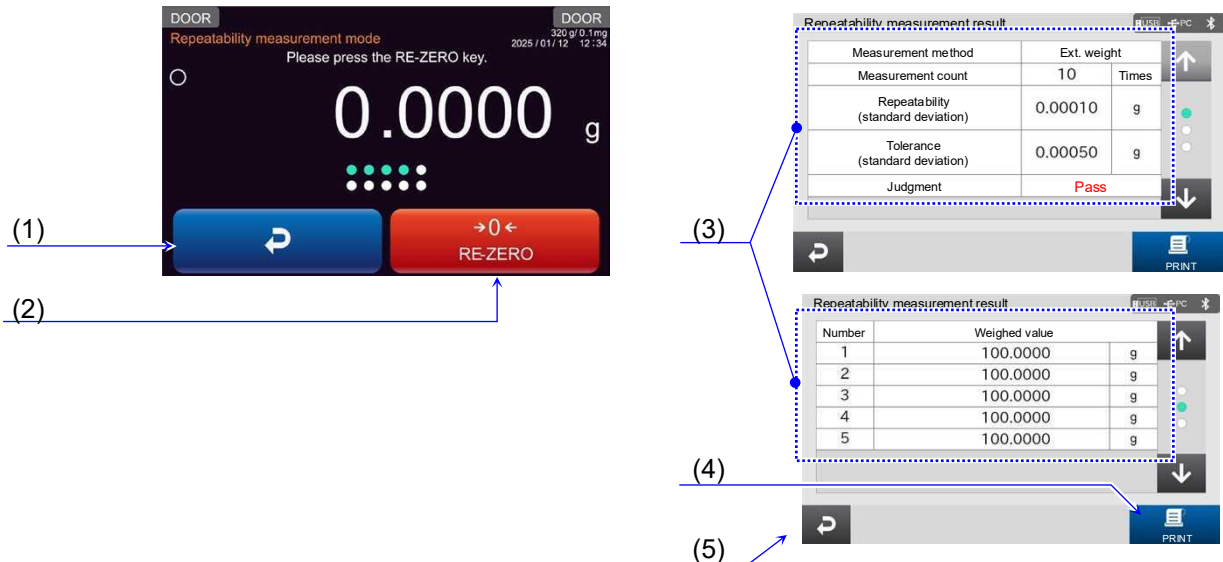

11.3.2. Repeatability measurement with the internal weight

Display settings: [MENU] key  > [Calibration test/check] button  > [Repeatability check] button  > [Repeatability measurement] screen. In this screen, with [Manual (external weight)] selected for the measurement method, select [Measure] button  > [Repeatability measurement] screen with an external weight.



	Name	Description
(1)	[Back] button	Returns to the previous screen.
(2)	[RE-ZERO] button	Sets the displayed value to zero.
(3)	Repeatability measurement result display	Repeatability measurement result display
(4)	[PRINT] button	Outputs the result to the device connected to the balance.
(5)	[Exit] button	Exits the screen that shows the repeatability measurement result.

11.4. Internal calibration test

Display settings: [MENU] key  > [Calibration test/check] button  > [Internal calibration test] button  > [Calibration test] screen.

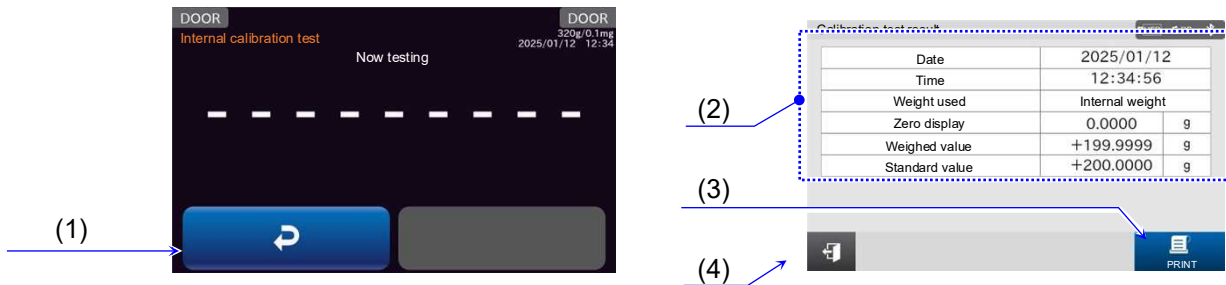

	Name	Description
(1)	[Back] button	Returns to the previous screen.
(2)	Calibration test result display	Displays the measurement result.
(3)	[PRINT] button	Outputs the measurement results to a device connected to the balance.*
(4)	[Exit] button	Exits the screen that shows the measurement result.



* It is automatically output if either [GLP output] or [GLP custom output] is set for [GLP output/Label output].

- ❑ The internal weight is used to perform the calibration test.
 - Be sure to warm up the balance with nothing on the weighing pan for at least an hour.
 - Do not apply vibration and the like to the balance during the calibration test.
 - When the test is completed, the [Calibration test result] screen is displayed.

CAUTION

- ❑ No sensitivity adjustment is performed.

11.5. External calibration test

Display settings: [MENU] key  > [Calibration test/check] button  > [External calibration test] button  > [External calibration test] screen.

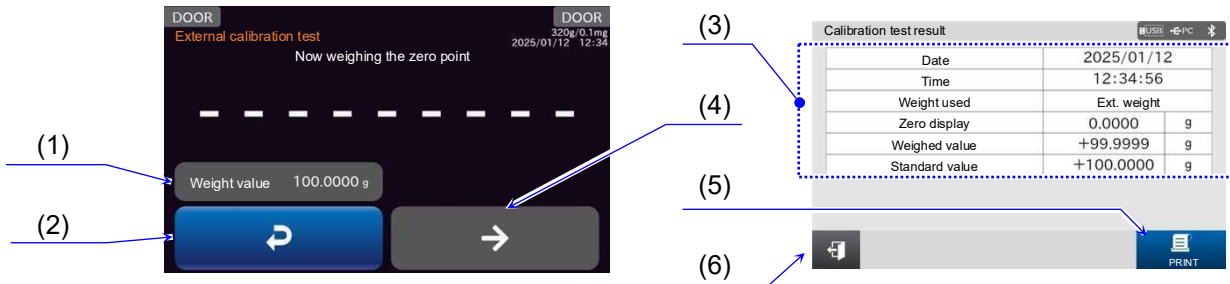

	Name	Description
(1)	External weight value input	Input the external weight value. Input range* ¹ This is common to the external weight value input field in the [Sensitivity adjustment setting] screen ("10.2. External sensitivity adjustment").
(2)	[Back] button	Returns to the previous screen.
(3)	Calibration test result display	Displays the measurement result.
(4)	[Confirm] button	Confirms the current input setting and proceeds to the next instruction.
(5)	[PRINT] button	Outputs the measurement results to a device connected to the balance.* ²
(6)	[Exit] button	Exits the screen that shows the measurement result.

***1** Input range

BH-225TE/BH-225DTE: 9.9 g to 200 g to 200.1 g
 BH-324TE: 9.9 g to 200 g to 300.1 g
 BH-224TE: 9.9 g to 200 g to 200.1 g



***2** It is automatically output if either [GLP output] or [GLP custom output] is set for [GLP output/Label output].

- An external weight is used to perform the calibration test.
 - Be sure to warm up the balance with nothing on the weighing pan for at least an hour.
 - Do not apply vibration and the like to the balance during the calibration test.
 - When the test is completed, the [Calibration test result] screen is displayed.

CAUTION

- No sensitivity adjustment is performed.

11.6. AND-MEET

Display settings: [MENU] key  > [Calibration test/check] button  > [AND-MEET] button 
> [AND-MEET] screen.

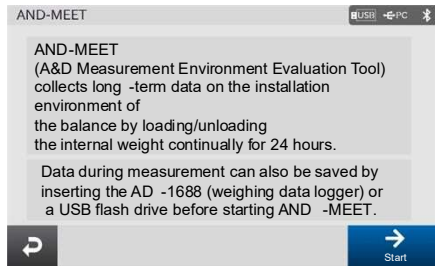

(2) [Back] button

(1) [Start] button

	Name	Description
(1)	[Start] button	Starts AND-MEET and displays [AND-MEET] screen (" 11.6.1. [AND-MEET weighing] screen ").
(2)	[Back] button	Returns to the [Calibration test/check] screen (" 11. Calibration Test/Check ").

AND-MEET measurement environment evaluation tool

- ❑ High-sensitivity analytical balances detect minute environmental changes that users cannot detect. This causes the measurement value to be unstable. This is especially so with a 0.01 mg model semi-microbalance. Using such a balance, the specified repeatability may not be obtained in many cases, depending on the environment where the balance is installed. Users may feel uneasy when it happens. However, it is not necessarily resolved even if they ask the balance manufacturers for help.
- ❑ AND-MEET constantly monitors the installation environment of the balance while simultaneously loading and unloading the internal weight of the balance automatically over 24 hours. AND-MEET evaluates temperature changes and the corresponding repeatability of measurement data over time. The span value is calculated by subtracting the zero point value from the value obtained when the internal weight is loaded on the balance. Then, the standard deviation of the ten consecutive span values is calculated to obtain the repeatability. The result is presented as a graph for visualization.
- ❑ Time is plotted on the X-axis of the graph. Changes in the zero point, span value, repeatability and temperature are plotted on the Y-axis. Through the graph, interaction between each item (changes in the zero point, span value or repeatability) and environmental changes (time and temperature) can be evaluated.

AND-MEET graph: points to check and measures to take





- ❑ A zero point drift occurs due to changes in the balance internal temperature caused by turning the power on. Warm up the balance until the balance reaches equilibrium with room temperature.
- ❑ Changes in temperature in a day are great:
Use an air conditioner to avoid changes in temperature.
- ❑ Sudden temperature changes occur:
If the causes of the temperature change such as a heat generating device are known, eliminate the causes.
- ❑ The temperature fine fluctuation occurs:
The air from the air conditioner may be blown directly to the balance. Use a breeze break or change the balance installation site to avoid the direct airflow to the balance from the air conditioner.
- ❑ The repeatability is bad even if changes in temperature are small:
The air from the air conditioner may be strong. Use a breeze break to avoid the direct airflow to the balance from the air conditioner. Sources of vibration may exist near the balance.

- ❑ The repeatability during the day is bad while the repeatability at midnight is good:
Human activities such as opening or closing the door, passing near the balance may influence the balance. Take appropriate measures to avoid passing near the balance while the balance is in use.
- ❑ Temporal poor repeatability:
Impact may have been applied to the balance or table on which the balance is installed. Or an earthquake may have occurred.
- ❑ Others:
Sudden changes in barometric pressure due to typhoon or building vibrations due to strong winds will influence the balance.

Environment to install a microbalance

- ❑ Location
The best location is the first floor of the rigid building built on solid ground. Locations along the coast or main roads may be influenced by winds and vibrations.
- ❑ Room
Corners of the rooms or areas near a pillar, far from the passage, door or air conditioner outlet and where there is no direct sunlight. A weighing table should be solid and made of stone or wood having low heat conductivity.
- ❑ Temperature / barometric pressure / static electricity
Changes in temperature in a day: within 4 °C
Changes in temperature in a short time: within 0.2 °C/30 minutes
Changes in barometric pressure in a day: within 10 hPa
Static electricity: Active elimination is required especially for the balance with a minimum display of 1 mg or less which is more prone to static electricity.



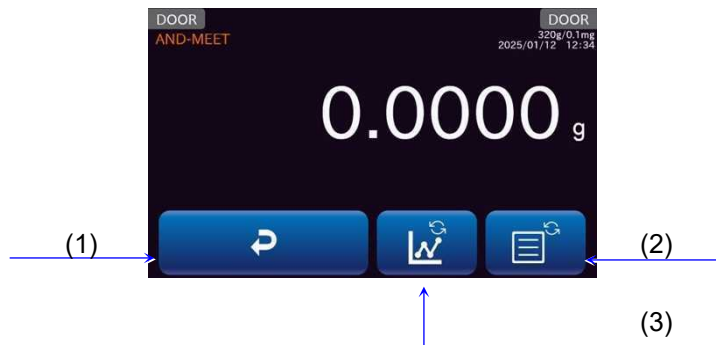

11.6.1. [AND-MEET weighing] screen

Display settings: [MENU] key  > [Calibration test/check] button  > [AND-MEET] button 
 > [Start] button  > [AND-MEET] screen.



	Name	Description
(1)	[Cancel] button	Cancels AND-MEET and displays the [AND-MEET result] screen ("11.6.5. [AND-MEET result list] screen ").
(2)	[List] button	Displays the [AND-MEET result list] screen ("11.6.5. [AND-MEET result list] screen ").
(3)	[Graph] button	Displays the [AND-MEET graph] screen ("11.6.2. [AND-MEET graph] screen ").

11.6.2. [AND-MEET graph] screen

Display settings: [MENU] key  > [Calibration test/check] button  > [AND-MEET] button 
 > [Start] button  > [Graph] button > [AND-MEET graph] screen.

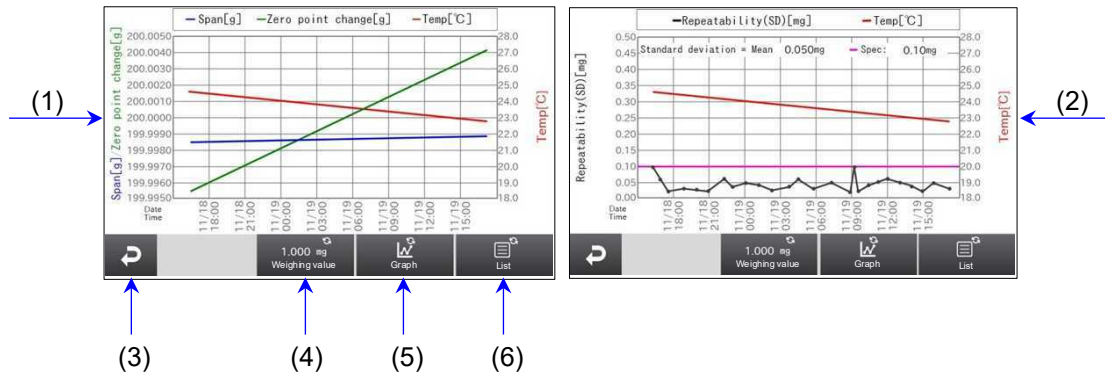

	Name	Description
(1)	Span/zero point change graph	Displays a span/zero point change graph. Time is plotted on the X-axis. Span/zero point change is plotted on the Y-axis 1. Temperature is plotted on the Y-axis 2.
(2)	Repeatability graph	Displays a repeatability graph. Time is plotted on the X-axis. Repeatability (standard deviation) is plotted on the Y-axis 1. Temperature is plotted on the Y-axis 2.
(3)	[Cancel] button	Cancels AND-MEET and displays the [AND-MEET result] screen ("11.6.5. [AND-MEET result list] screen").
(4)	[Weighing value] button	Displays the [AND-MEET] screen ("11.6.1. [AND-MEET weighing] screen").
(5)	[Graph] button	Switches the zero point/span/temperature graph and the repeatability/temperature graph.
(6)	[List] button	Displays the [AND-MEET result list] screen ("11.6.5. [AND-MEET result list] screen").

11.6.3. Description of a graph: temperature/zero point change/span

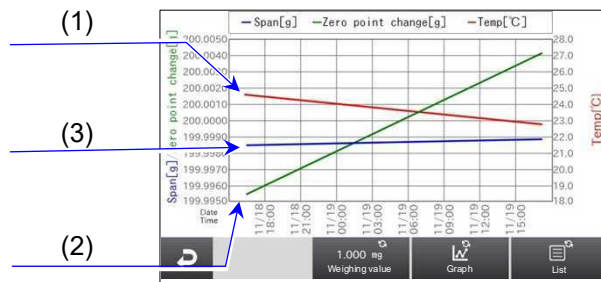



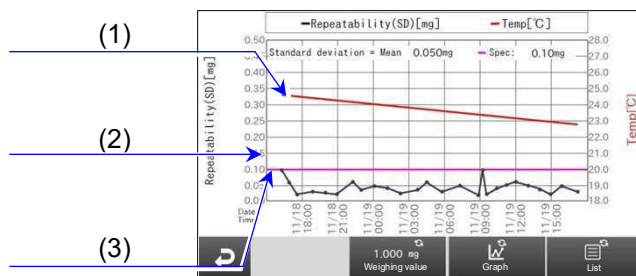

	Name	Description
(1)	Temperature (red)	Indicates the temperature. The scale is on the right side of the Y-axis.
(2)	Zero point change (green)	Indicates the changes in zero point. Although the actual value is near zero, the value in the graph has the offset value as large as the span value added to plot on the same graph with the span value. The scale is on the left side of the Y-axis.
(3)	Span (blue)	Indicates the span value, the value obtained by subtracting the zero value from the value displayed when the internal weight is loaded. The scale is on the left side of the Y-axis.

11.6.4. Description of a graph: temperature/repeatability



	Name	Description
(1)	Temperature (red)	Indicates the temperature. The scale is on the right side of the Y-axis.
(2)	Spec. (pink)	Reference line (standard deviation) for repeatability specified in the brochure. The scale is on the left side of the Y-axis.
(3)	Repeatability (black)	Indicates the standard deviation of ten span values. The scale is on the left side of the Y-axis.

11.6.5. [AND-MEET result list] screen

Display settings: [MENU] key  > [Calibration test/check] button  > [AND-MEET] button 
 > [Start] button  > [List] button > [AND-MEET list] screen.

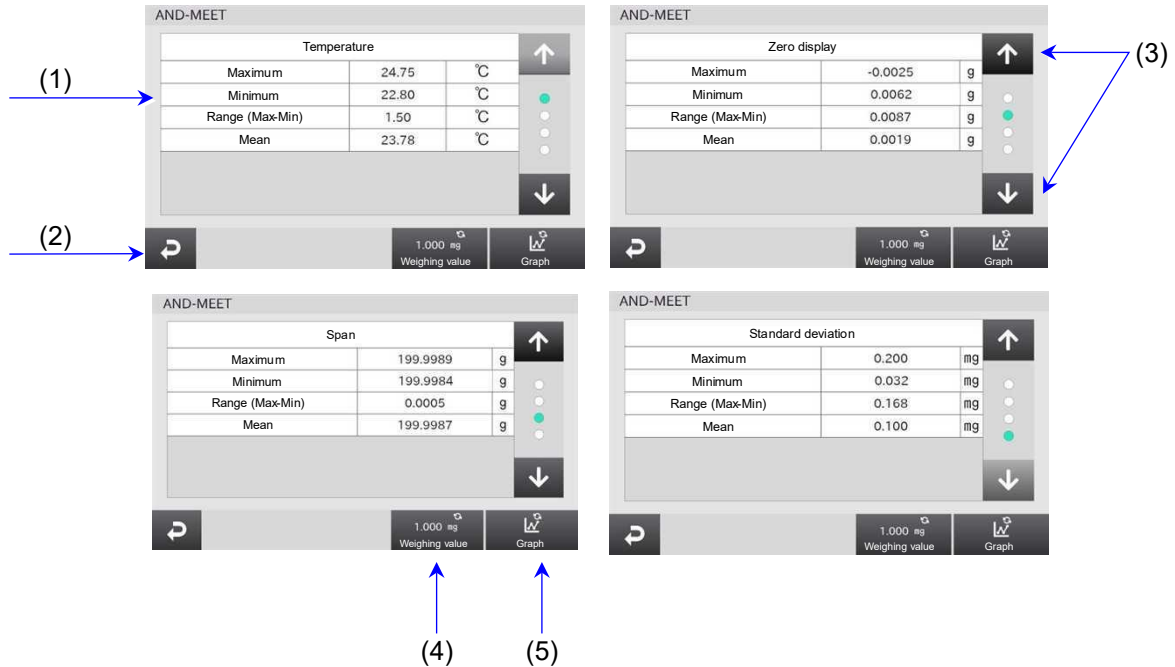

	Name	Description
(1)	AND-MEET result table	Displays the temperature, zero point, span, the standard deviation's maximum value, minimum value, range, and average value.
(2)	[Cancel] button	Cancels AND-MEET and displays the [AND-MEET result] screen.
(3)	[Scroll] buttons	Select the page.
(4)	[Weighing value] button	Displays the [AND-MEET] screen ("11.6.1. [AND-MEET weighing] screen").
(5)	[Graph] button	Displays the [AND-MEET graph] screen ("11.6.2. [AND-MEET graph] screen").

11.6.6. [AND-MEET result] screen

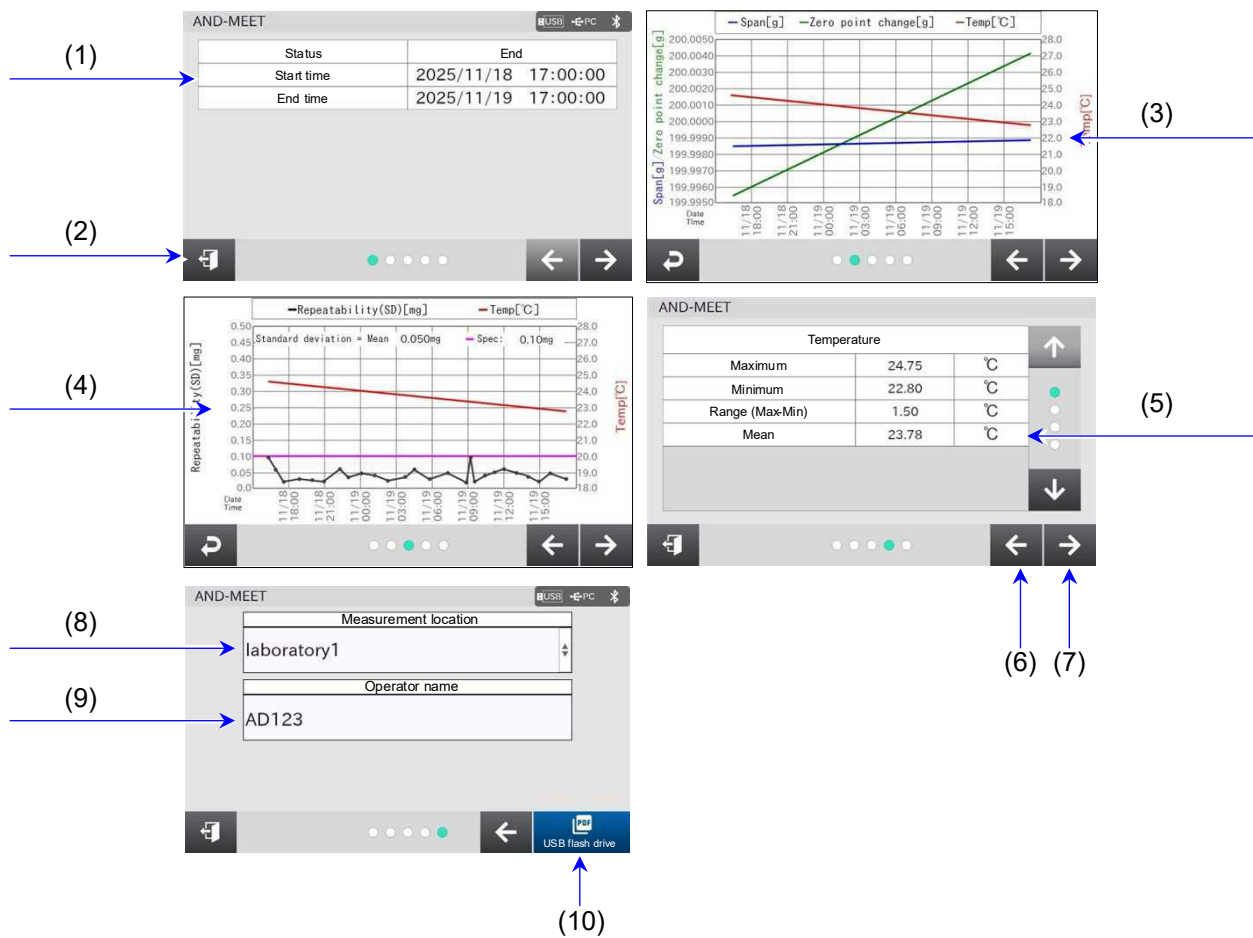

	Name	Description
(1)	AND-MEET status	Displays either 'Exit' or 'Cancel'. Also displays the time to start and exit the AND-MEET.
(2)	[Exit] button	Exits the AND-MEET.
(3)	Span/zero point change graph	Refer to "11.6.3. Description of a graph: temperature/zero point change/span".
(4)	Repeatability graph	Refer to "11.6.4. Description of a graph: temperature/repeatability".
(5)	AND-MEET result table	Displays the temperature, zero point, span, the standard deviation's maximum value, minimum value, range, and average value.
(6)	[Back] button	Returns to the previous screen.
(7)	[Next] button	Transitions to the next page.
(8)	Location input	Input the measurement location.
(9)	Operator name	Input the name of user who operates the AND-MEET.
(10)	[USB flash drive] button	Outputs the PDF data of the AND-MEET result to the USB flash drive.

11.6.7. AND-MEET analysis graph example

AND-MEET Analysis Graph



Start time : 2025/04/01 18:14 End time : 2025/04/02 18:14
 Location : a&d

Balance

Model : BH-324TE Capacity : 320g Readability : 0.1mg
 Serial No. : T2400000 ID No. : LAB-012345678

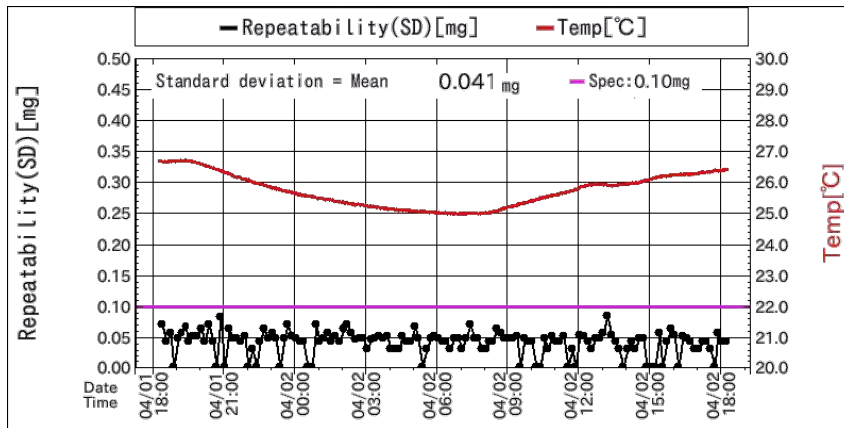
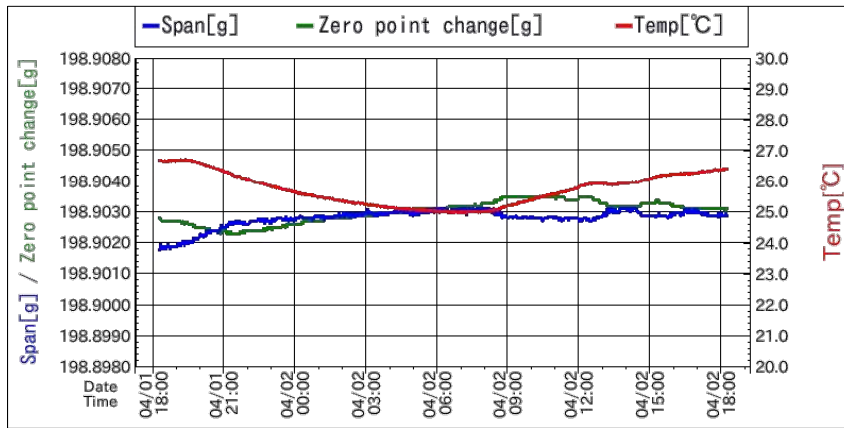



	Maximum	Minimum	Range(Max-Min)	Mean
Temp[°C]	26.75	24.98	1.77	25.74
Zero[g]	0.0007	-0.0005	0.0012	0.0002
Span[g]	198.9031	198.9018	0.0013	198.9028
Std deviation[mg]	0.084	0.000	0.084	0.041

Remarks

Signature (Operator) A&D

Signature (Manager)

11.7. Daily/periodic check settings

Display settings: [MENU] key  > [Calibration test/check] button  > [Settings] button  > [Daily/periodic check settings] screen.

(1) [Standard value setting] button

(2) [Daily/periodic check reminder] button



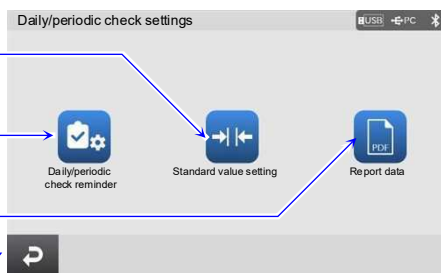

(3) [Report data] button

(4) [Back] button



	Name	Description
(1)	[Standard value setting] button	Displays the [Standard value setting] screen (" 11.9. Standard value setting ").
(2)	[Daily/periodic check reminder] button	Displays the [Daily/periodic check reminder] screen (" 11.8. Daily/periodic check reminder ").
(3)	[Report data] button	Displays the [Report data] screen (" 11.10. Report data ").
(4)	[Back] button	Returns to the previous screen.

11.8. Daily/periodic check reminder

Display settings: [MENU] key  > [Calibration test/check] button  > [Settings] button  > [Daily/periodic check reminder] button  > [Daily/periodic check reminder] screen.

(1) Daily check reminder before the start of weighing

(2) Periodic check cycle

(3) Last periodic check date

(4) [Back] button

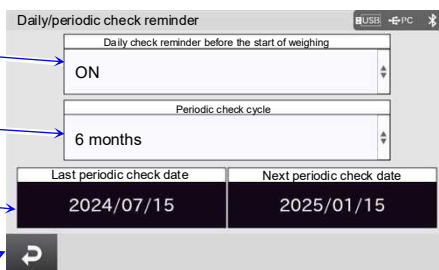





(5) Next periodic check date

	Name	Setting value (setting range)	Description
(1)	Daily check reminder before the start of weighing	OFF, ON	Sets the daily check reminder before the start of weighing.
(2)	Periodic check cycle	OFF , 1 month, 6 months, 1 year, 2 years	Select the periodic check cycle.
(3)	Last periodic check date	-	Displays the last periodic check date.
(4)	[Back] button	-	Returns to the previous screen.
(5)	Next periodic check date	-	Displays the next periodic check date.

Settings in the red box are default values (factory settings).



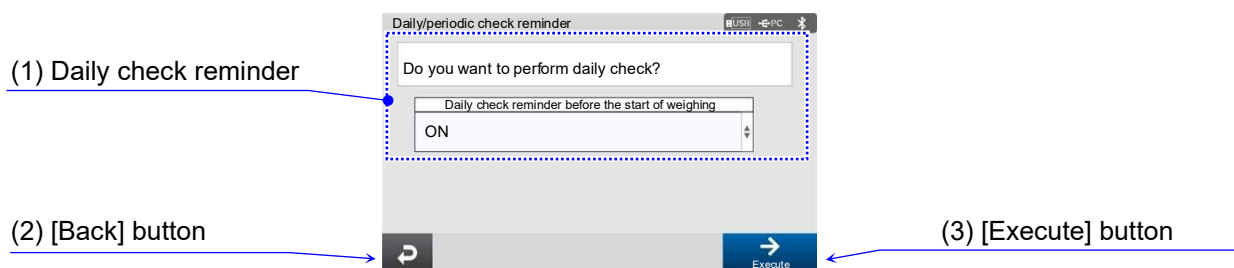

11.8.1. Startup screen when the daily check reminder is set to ON

Display settings: [MENU] key  > [Calibration test/check] button  > [Settings] button  > [Daily/periodic check reminder] button  > Daily check reminder before the start of weighing button > Select [ON].
Use the [ON:OFF] key  to turn on the display > [Daily/periodic check reminder] screen for daily check.



	Name	Description
(1)	Daily check reminder	Displayed at startup if [Daily check reminder before the start of weighing] is set to ON.
(2)	[Back] button	Cancels the check and returns to the [HOME] screen.
(3)	[Execute] button	Executes the check.



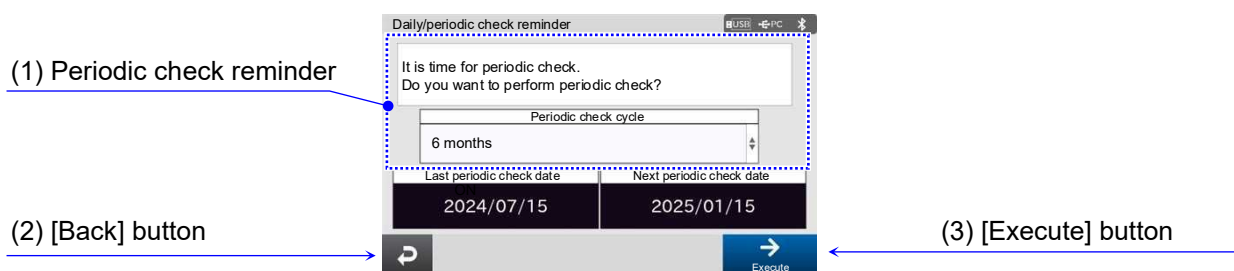

11.8.2. Startup screen of the periodic check reminder

Display settings: [MENU] key  > [Calibration test/check] button  > [Settings] button  > [Daily/periodic check reminder] button  > Periodic check reminder button > Select [except OFF].
Use the [ON:OFF] key  to turn on the display > [Daily/periodic check reminder] screen for periodic check.



	Name	Description
(1)	Periodic check reminder	Displayed at startup if the periodic check reminder is set to ON.
(2)	[Back] button	Cancels the check and returns to the [HOME] screen.
(3)	[Execute] button	Executes the check.



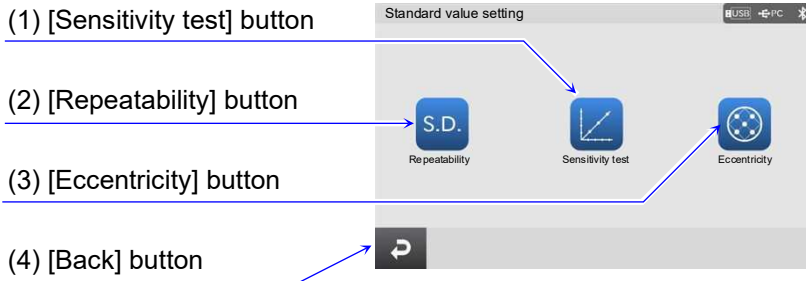

11.9. Standard value setting

Display settings: [MENU] key  > [Calibration test/check] button  > [Settings] button  > [Standard value setting] button  > [Standard value setting] screen.



	Name	Description
(1)	[Sensitivity test] button	Displays the [Standard value setting: Sensitivity test] screen (" 11.9.2. Standard value setting: Sensitivity test ").
(2)	[Repeatability] button	Displays the [Standard value setting: Repeatability] screen (" 11.9.1. Standard value setting: Repeatability ").
(3)	[Eccentricity] button	Displays the [Standard value setting: Eccentricity] screen (" 11.9.3. Standard value setting: Eccentricity ").
(4)	[Back] button	Returns to the previous screen.

11.9.1. Standard value setting: Repeatability



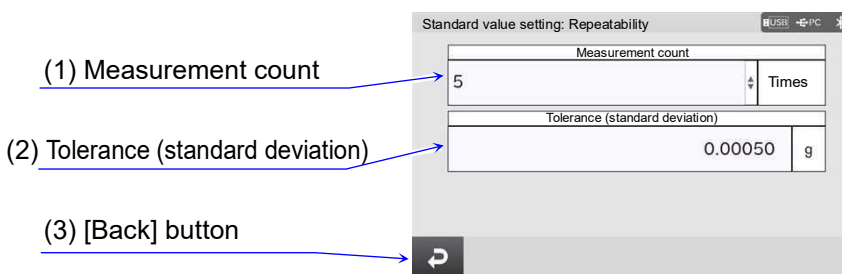

Display settings: [MENU] key  > [Calibration test/check] button  > [Settings] button  > [Standard value setting] button  > [Repeatability] button  > [Standard value setting: Repeatability] screen.



	Name	Description
(1)	Measurement count	Set the measurement count.
(2)	Tolerance (standard deviation)	Set the tolerance (standard deviation).
(3)	[Back] button	Returns to the previous screen.

- ❑ You can change the repeatability settings.
The settings in this screen are common to the repeatability settings screen for the periodic check.

11.9.2. Standard value setting: Sensitivity test

Display settings: [MENU] key  > [Calibration test/check] button  > [Settings] button 
 > [Standard value setting] button  > [Sensitivity test] button  > [Standard value setting: Sensitivity test] screen.

(1) Number of loading points for measurement

(2) Measuring load 1

(3) Measuring load 2

(4) [Back] button

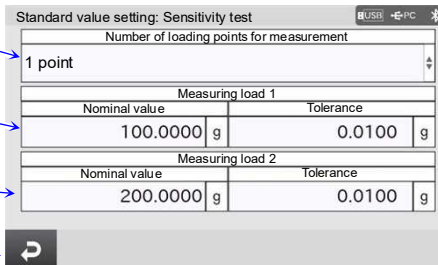





	Name	Setting value (setting range)	Description
(1)	Number of loading points for measurement	2 points, 1 point	Set the number of loading points for measurement.
(2)	Measuring load 1	-	Set the nominal value and tolerance.
(3)	Measuring load 2	-	Set the nominal value and tolerance.
(4)	[Back] button	-	Returns to the previous screen.

Settings in the red box are default values (factory settings).

You can change the sensitivity test settings.

The settings in this screen are common to the sensitivity test settings screen for the periodic check.

11.9.3. Standard value setting: Eccentricity

Display settings: [MENU] key  > [Calibration test/check] button  > [Settings] button  > [Standard value setting] button  > [Eccentricity] button  > [Standard value setting: Eccentricity] screen.

(1) Tolerance

(maximum deviation from the center value)

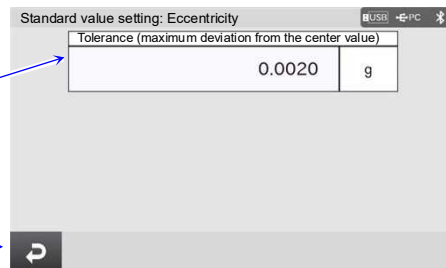





(2) [Back] button

	Name	Description
(1)	Tolerance (maximum deviation from the center value)	Set the tolerance (maximum deviation from the center value).
(2)	[Back] button	Returns to the previous screen.

You can change the eccentricity settings.

The settings in this screen are common to the eccentricity settings screen for the periodic check.

11.10. Report data

Display settings: [MENU] key  > [Calibration test/check] button  > [Settings] button 
> [Report data] button  > [Report data] screen.

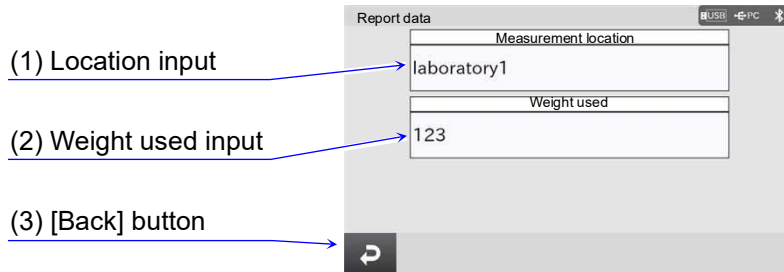

	Name	Description
(1)	Location input	Input the measurement location.
(2)	Weight used input	Input the weight used.
(3)	[Back] button	Returns to the previous screen.

□ The [Report data] screen displays the measurement location and weight used.

12. Filter Settings

Display settings: [MENU] key  > [Filter Settings] button  > [Filter settings] screen.

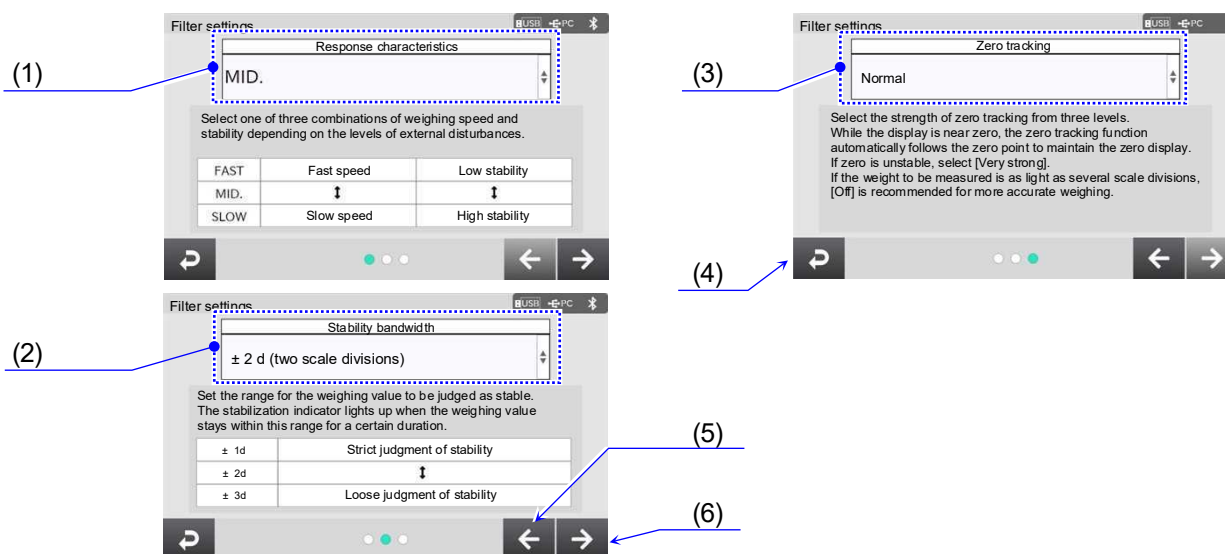

	Name	Setting value (setting range)	Description
(1)	Response characteristics	FAST, MID. , SLOW	You can set the level of the response to external disturbances that affect the balance.
(2)	Stability bandwidth	±1 d, ±2 d , ±3 d	Sets the fluctuation range where the stabilization indicator of the weighing value is displayed.
(3)	Zero tracking	OFF, Normal , Strong, Very strong	Changes the setting of the zero tracking.
(4)	[Back] button	-	Returns to the previous screen.
(5)	[Previous] button	-	Returns to the previous screen.
(6)	[Next] button	-	Transitions to the next screen.

Settings in the red box are default values (factory settings).

"d" represents scale division.

12.1. Commentary on filter settings

Response characteristics

FAST



SLOW

The display shows an acute response to weight variation. Reduce the setting value when weighing powder or liquid, weighing extremely lightweight samples, or prioritizing the operating efficiency over the stability of the weighing value.

The display shows a gradual response to weight variation. Increase the setting value when the weighing value does not get stabilized depending on the usage environment.

Stability bandwidth

The setting to determine that the weighing value is stable. It shows the stabilization indicator when the fluctuation range in a certain time of period gets lower than the setting value, and outputs the weighing value based on the internal settings. This setting affects the automatic printing.

The readability being displayed is 1 d.

(Example) If "No blank" is selected with BH-324TE and 0.0001-g display is chosen, 0.0001 g is shown as 1 d.

±1 d



±3 d

The stabilization indicator will not display if the value is not stable enough, and it will disappear if there are even slight fluctuations in the weighing value. Reduce the setting value for precise weighing.



The display does not easily respond to a slight weight variation. To prevent the weighing value from drifting due to vibration or drafts, set the parameter to be a high value.

Zero tracking

The function to automatically track the zero point and keep the zero display when the display shows zero and the zero point slightly fluctuates depending on usage environment. A tracking level can be selected from 3 levels. Increase the setting value if zero is not stabilized. Do not perform zero tracking when the weighing value is slightly over d. "d" represents scale division.

Setting value	Description	
OFF	The zero point is not tracked with zero tracking.	
Normal	±1 d/1 second	The zero point is normally tracked with zero tracking.
Strong	±1.5 d/0.5 seconds	The zero point is strongly tracked with zero tracking.
Very strong	±1.5 d/0.2 seconds	The zero point is very strongly tracked with zero tracking.

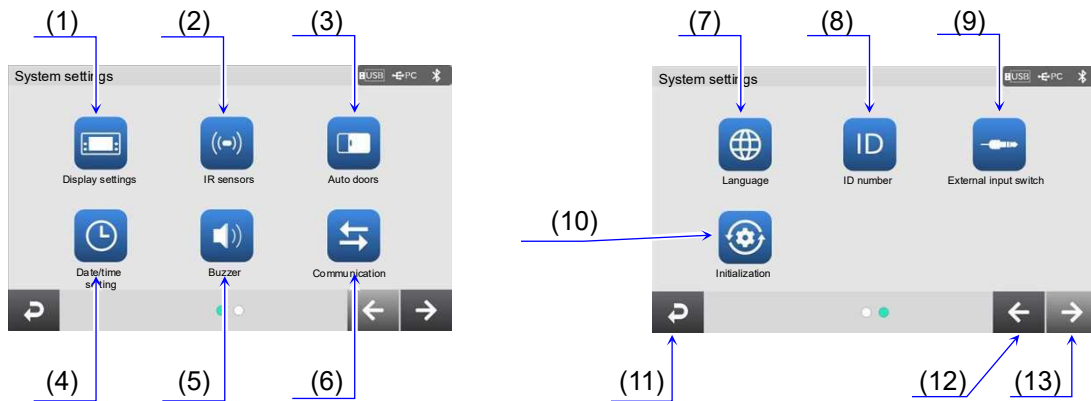

13. System Settings

Display settings: [MENU] key  > [System Settings] button  > [System settings] screen.



	Name	Description
(1)	[Display settings] button	Displays the [Display settings] screen.
(2)	[IR sensors] button	Displays the [IR sensor] settings screen (" 13.2. IR sensors "). You can configure the settings regarding the sensitivity and opening/closing of the breeze break doors for the left and right IR sensors.
(3)	[Auto doors] button	Displays the [Auto doors] settings screen (" 13.3. Breeze break auto doors "). You can configure the settings for the open position of the breeze break doors for the left and right IR sensors.
(4)	[Date/time] button	Displays the [Date/time setting] screen (" 13.4. Date/time setting ").
(5)	[Buzzer] button	Displays the [Buzzer] settings screen (" 13.5. Buzzer ").
(6)	[Communication] button	Displays the [Communication] screen (" 13.6. Communication "). You can configure settings for the output data, connections and communication method.
(7)	[Language] button	Displays the [Language] screen (" 13.21. Language ").
(8)	[ID number] button	Displays the [ID number] settings screen (" 13.22. ID number settings ").
(9)	[External input switch] button	Displays the [External input switch settings] screen (" 13.23. External input switch ").
(10)	[Initialization] button	Resets the various settings for the balance to the factory settings.
(11)	[Back] button	Returns to the previous screen.
(12)	[Previous] button	Returns to the previous screen.
(13)	[Next] button	Transitions to the next screen.

13.1. Display settings

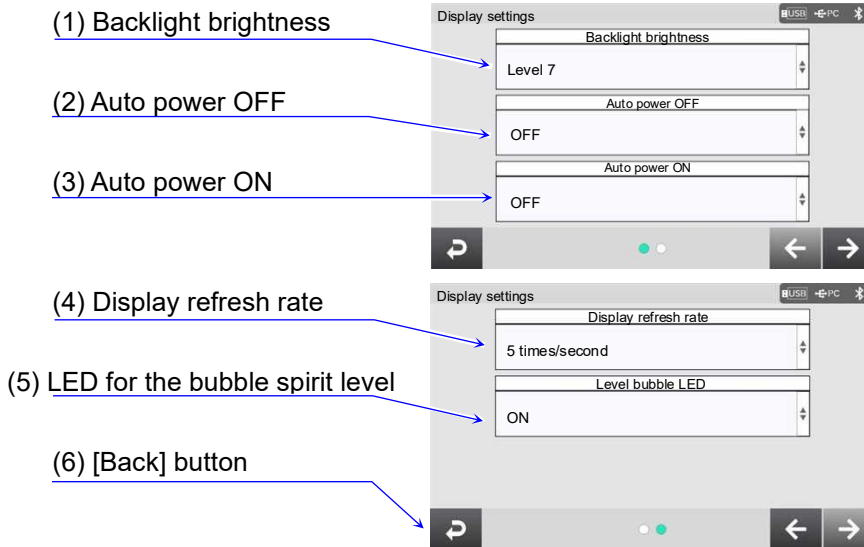

Display settings: [MENU] key  > [System Settings] button  > [Display settings] button  > [Display settings] screen.



	Name	Setting value (setting range)	Description
(1)	Backlight brightness	Level 1, Level 2, Level 3, Level 4, Level 5, Level 6, Level 7	Selects the brightness of the backlight of the display.
(2)	Auto power OFF	OFF , ON (10 minutes)	Turns off the display after 10 minutes has elapsed without any operations.
(3)	Auto power ON	OFF , ON	This setting turns on the weighing mode display when the AC adapter is connected.
(4)	Display refresh rate	5 times/second , 10 times/second	Selects the display and output rate. This is common to the setting described in "13.8. Data output mode".
(5)	LED for the bubble spirit level	OFF, ON	Select the on/off setting for the LED for the bubble spirit level.
(6)	[Back] button	-	Returns to the previous screen.

Settings in the red box are default values (factory settings).

13.2. IR sensors

Display settings: [MENU] key  > [System Settings] button  > [IR sensors] button  > [IR sensor] settings screen.

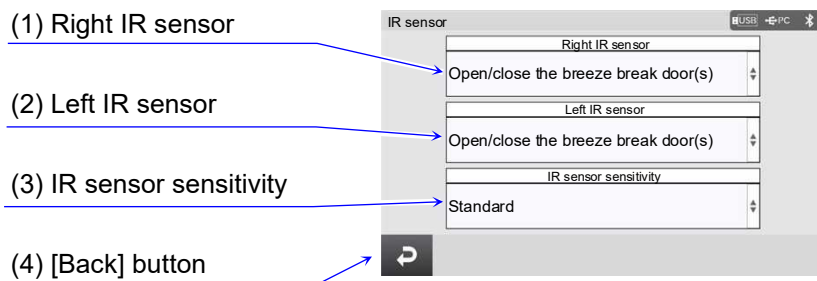



	Name	Setting value (setting range)	Description
(1)	Right IR sensor	OFF, Breeze break doors , RE-ZERO, PRINT	Configures the function of the left and right IR sensors.
(2)	Left IR sensor	OFF, Breeze break doors , RE-ZERO, PRINT	
(3)	IR sensor sensitivity	Least sensitive, Standard , Most sensitive	You can select the IR sensor sensitivity.
(4)	[Back] button	-	Returns to the previous screen.

Settings in the red box are default values (factory settings).

- ❑ BH-T series analytical balances are equipped with IR sensors that allow operation without directly touching the balance display.
At factory settings, the IR sensors on the left and right of the display are assigned to open and close the breeze break doors.
You can change the settings for the IR sensors in this device settings screen.

13.3. Breeze break auto doors

Display settings: [MENU] key  > [System Settings] button  > [Auto doors] button  > [Auto doors] settings screen.

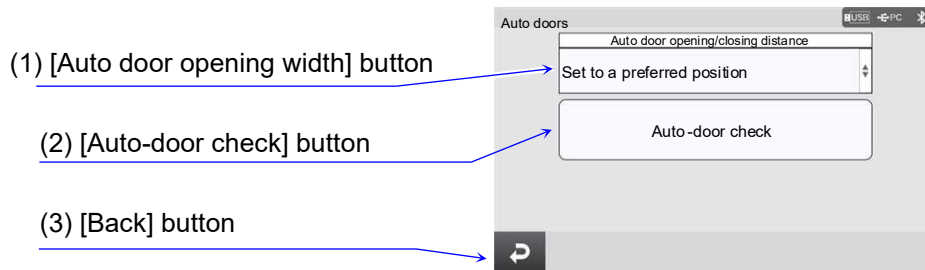

	Name	Setting value (setting range)	Description
(1)	[Auto door opening width] button	Full, Half, Set the distance	Changes the open position of the breeze break doors.
(2)	[Auto-door check] button	-	Initiates the check of the breeze break doors. Execute this when changing the connection of the joint(s).
(3)	[Back] button	-	Returns to the previous screen.



Settings in the red box are default values (factory settings).

- ❑ The BH-T series balances feature a breeze break with auto doors that can be opened and closed without touching them.

The position of the breeze break auto doors is automatically detected by the IR sensors mounted on the sides of the breeze break. At factory settings, the IR sensors on the left and right sides of the display are assigned to open and close the breeze break door(s). By default, the open position of the breeze break is automatically detected at the last opened position.

By changing the function table of the balance, it is also possible to fix the doors to fully open or half open.

13.4. Date/time setting

Display settings: [MENU] key  > [System Settings] button  > [Date/time] button  > [Date/time setting] screen.

(1) Current date and time

(2) Date and time setting

(3) [Set] button

(4) [Back] button

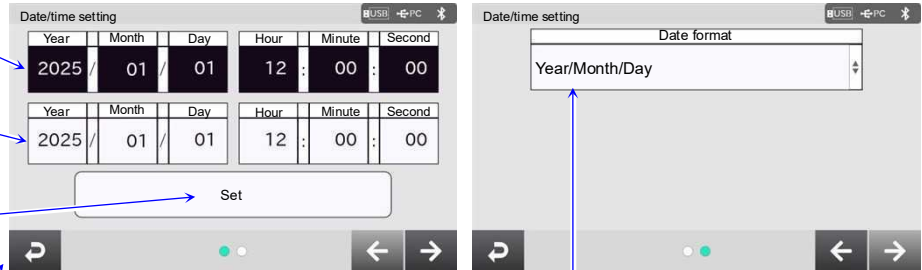

(5) Date format



	Name	Setting value (setting range)	Description
(1)	Current date and time	-	Displays the currently set date and time.
(2)	Date and time setting	-	Input the date and time that you want to set.
(3)	[Set] button	-	Changes the settings for the date/time.
(4)	[Back] button	-	Returns to the previous screen.
(5)	Date format	Year/Month/Day, Month/Day/Year, Day/Month/Year	Sets the order of the year, month and day.

- ❑ The balance is equipped with a clock and calendar function. When the settings described in "[13.9. Data to be added](#)" are set, the time/date can be added to the weighing value output.
- ❑ Do not enter invalid values such as a non-existing date when setting the time and date.

13.5. Buzzer

Display settings: [MENU] key  > [System Settings] button  > [Buzzer] button  > [Buzzer] settings screen.

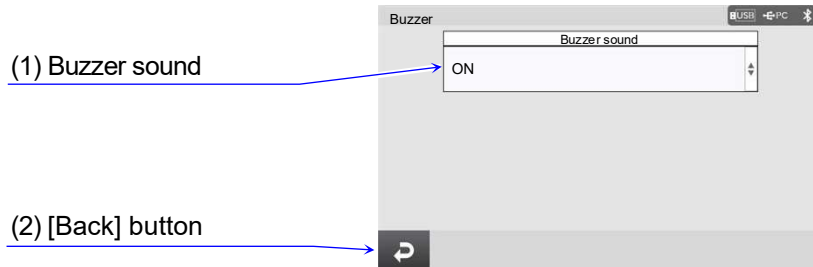



	Name	Setting value (setting range)	Description
(1)	Buzzer sound	OFF, ON	Selects ON/OFF for the built-in buzzer that sounds when a key is operated or the state changes.
(2)	[Back] button	-	Returns to the previous screen.

Settings in the red box are default values (factory settings).

- You can change the setting of the built-in buzzer that sounds when a key is operated or the state changes.



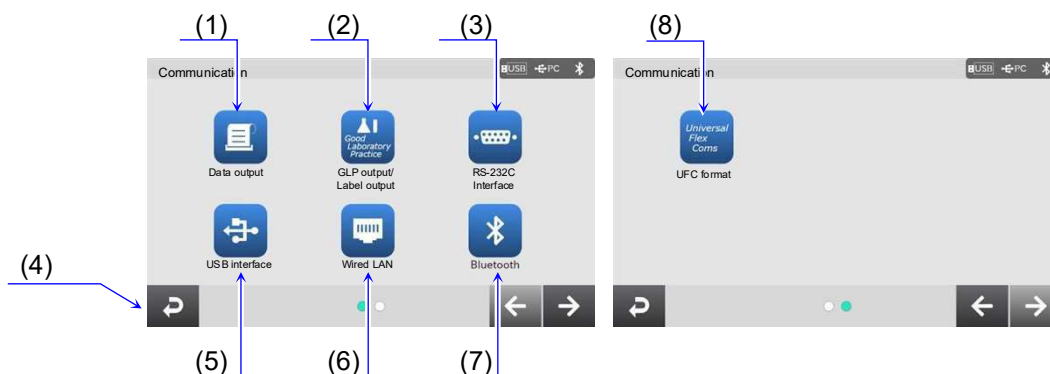

13.6. Communication

Display settings: [MENU] key  > [System Settings] button  > [Communication] button  > [Communication] screen.



	Name	Description
(1)	[Data output] button	Displays the [Data output] screen (" 13.7. Data output "). You can select the output mode and configure the data to be added, output settings, and command settings.
(2)	[GLP output / Label output] button	Displays the [GLP output / Label output] screen. (" 13.12. GLP output / Label output ")
(3)	[RS-232C interface] button	Displays the [RS-232C interface] screen (" 13.16. RS-232C interface ").
(4)	[Back] button	Returns to the previous screen.
(5)	[USB interface] button	Displays the [USB interface] settings screen (" 13.17. USB interface ").
(6)	[Wired LAN] button	Displays the [Wired LAN] screen (" 13.18. Wired LAN port ").
(7)	[Bluetooth] button	Displays the [Bluetooth] screen (" 13.19. Bluetooth ").
(8)	[UFC format] button	Displays the [UFC format] screen (" 13.20. UFC format ").



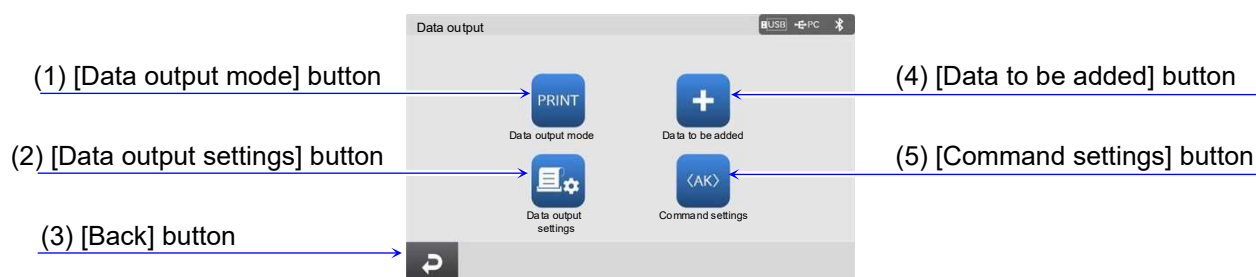

13.7. Data output

Display settings: [MENU] key  > [System Settings] button  > [Communication] button  > [Data output] button  > [Data output] screen.



	Name	Description
(1)	[Data output mode] button	Displays the [Data output mode] screen.
(2)	[Data output settings] button	Displays the [Data output settings] screen (" 13.10. Data output settings ").
(3)	[Back] button	Returns to the previous screen.
(4)	[Data to be added] button	Displays the [Data to be added] screen (" 13.9. Data to be added ").
(5)	[Command settings] button	Displays the [Command settings] settings screen (" 13.11. Command settings ").

13.8. Data output mode

Display settings: [MENU] key  > [System Settings] button  > [Communication] button  > [Data output] button  > [Data output mode] button  > [Data output mode] screen.

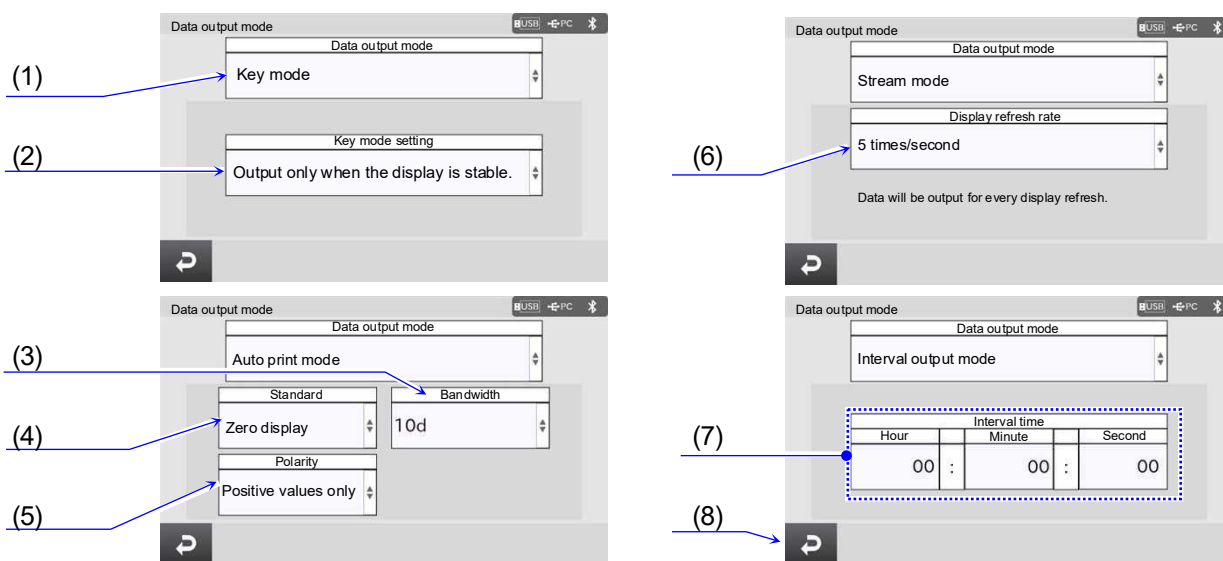





	Name	Setting value (setting range)	Description
(1)	Data output mode	Key mode , Auto print mode, Stream mode, Interval output mode	Selects the output timing for the selected data.
(2)	Key mode setting	Output only when the display is stable , Output regardless of whether the display is stable or unstable, Output after the display becomes stable	Selects the output condition for the weighing value.
(3)	Bandwidth	10 d , 100 d, 1000 d	Selects the auto print bandwidth.
(4)	Standard	Zero display , Last stable value	Selects the standard for the weighing value.
(5)	Polarity	Positive values only , Negative values only, Both positive and negative values	Selects the auto print polarity.
(6)	Display refresh rate	5 times/second , 10 times/second	Selects the display and output rate. This is common to the setting described in "13.1. Display settings".
(7)	Interval time*	-	Sets the interval time for outputting the weighing value.
(8)	[Back] button	-	Returns to the previous screen.

Settings in the red box are default values (factory settings). "d" represents scale division.

- You can change the data output timing for the balance in the [Data output mode] screen.
 - * Depending on the interval time and baud rate, all data may not be transmitted unless the baud rate is increased.
- For details on the data output mode, refer to "19.1. Data output mode".

13.9. Data to be added

Display settings: [MENU] key  > [System Settings] button  > [Communication] button 
 [Data output] button  > [Data to be added] button  > [Data to be added] screen.

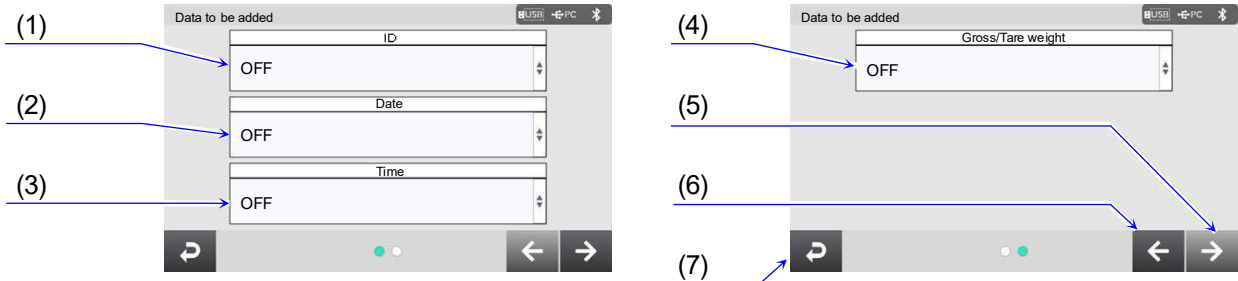





	Name	Setting value (setting range)	Description
(1)	ID	OFF , ON	Whether or not to add ID to the output data.
(2)	Date	OFF , ON	Whether or not to add the date to the output data.
(3)	Time	OFF , ON	Whether or not to add the time to the output data.
(4)	Gross/Tare weight	OFF , Tare weight, Gross weight, Gross weight + Tare weight	Whether to add gross/tare weight, etc. to the output data or not.
(5)	[Next] button	-	Transitions to the next screen.
(6)	[Previous] button	-	Returns to the previous screen.
(7)	[Back] button	-	Returns to the previous screen.

Settings in the red box are default values (factory settings).

You can select to add the ID, date and time to the output data in the [Data to be added] screen.

13.10. Data output settings



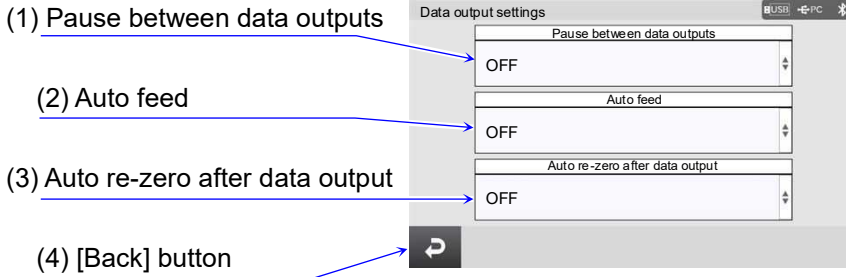

Display settings: [MENU] key  > [System Settings] button  > [Communication] button  > [Data output] button  > [Data output settings] button  > [Data output settings] screen.



	Name	Setting value (setting range)	Description
(1)	Pause between data outputs	OFF , 1.6 seconds	Selects the pause between data outputs.
(2)	Auto feed	OFF , 1 line	Selects the line feed after data output.
(3)	Auto re-zero after data output	OFF , ON	Sets the function to automatically set to zero after data output.
(4)	[Back] button	-	Returns to the previous screen.

Settings in the red box are default values (factory settings).

13.11. Command settings

Display settings: [MENU] key  > [System Settings] button  > [Communication] button  > [Data output] button  > [Command settings] button  > [Command settings] screen.

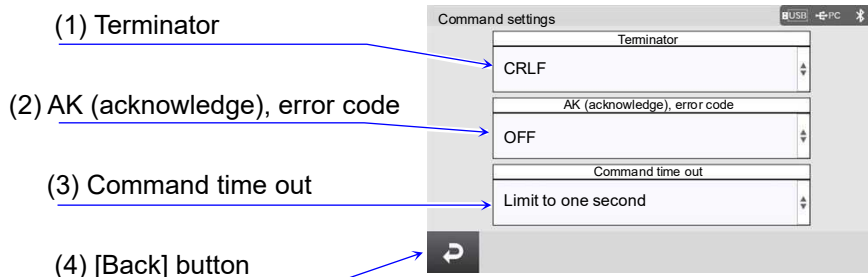

	Name	Setting value (setting range)	Description
(1)	Terminator	CR LF, CR	Selects the terminator for the output data.
(2)	AK (acknowledge), error code	OFF, ON	Select the response (received, processing or process completed) to all commands sent from PC or PLC.
(3)	Command time out	No limit, Limit to one second	Sets the command timeout.
(4)	[Back] button	-	Returns to the previous screen.

CR LF Settings in the red box are default values (factory settings).



AK: Acknowledgment, ASCII 06h. CR: Carriage return, ASCII 0Dh. LF: Line feed, ASCII 0Ah.

- ❑ When [AK (acknowledge), error code] is set to ON in the command settings, the balance always responds to reception of all commands sent from a PC or a PLC. Checking the code that is responded improves the reliability of the communication.

Balance response

When [AK (acknowledge), error code] is set to ON in the function table, the balance responds as follows.

- ❑ When a command requesting data is sent to the balance:
 - If the balance cannot send the requested data, it sends an error code (EC, E_{xx}).
 - If the balance can output the requested data, it sends the requested data.
- ❑ When a command controlling the balance is sent to the balance:
 - If the balance cannot execute the command, it sends an error code (EC, E_{xx}).
 - If the balance can execute the command, it sends the AK code (acknowledgment, ASCII 06h).

Command	Description
ON	Turns the display on.
P	Turns the display on/off. (Only when the display is on.)
R, RZ	Same as the [RE-ZERO] button  .
T, TR	Same as the [TARE] button  .
ZR	Zero: If the load is within $\pm 2\%$ of the capacity from the initial zero point, the zero point is updated, the tare value is cleared and the display is set to zero. If the load exceeds $\pm 2\%$, no processing is done.
CAL	Executes the internal sensitivity adjustment.
EXC	Executes the external sensitivity adjustment.

13.12. GLP output/Label output



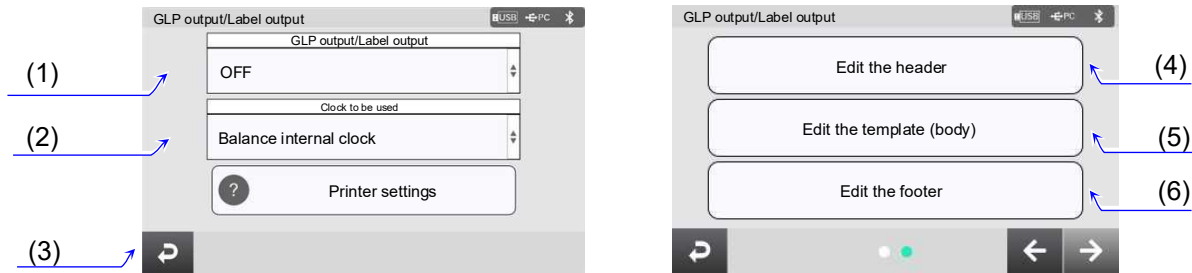

Display settings: [MENU] key  > [System Settings] button  > [Communication] button  > [GLP output/Label output] button .



	Name	Setting value (setting range)	Description
(1)	GLP output/Label output	OFF , GLP output, GLP Custom output, Label output	If the setting is changed, GLP output or label output can be performed.
(2)	Clock to be used	Balance internal clock , External device clock	Sets the clock for GLP output.
(3)	[Back] button	-	Returns to the previous screen.
(4)	[Edit the header] button	-	Displays the [Header] screen (" 13.14.5. Header ") when "GLP custom output" is set.
(5)	[Edit the template (body)] button	-	Displays the [Template] screen (" 13.14.1. Template ") when "GLP custom output" is set. Displays the [Template] screen (" 13.15.1. Template ") when "Label output" is set.
(6)	[Edit the footer] button	-	Displays the [Footer] screen (" 13.14.7. Footer ") when "GLP custom output" is set.

Settings in the red box are default values (factory settings).

13.13. GLP output

Display settings: [MENU] key  > [System Settings] button  > [Communication] button  > [GLP output/Label output] button  > [GLP output] screen.
[HOME] key  > [HOME] screen.



	Name	Description
(1)	[PRINT] button	Outputs the weighing data to the device connected to the balance. The output content will vary depending on the template selected.
(2)	[GLP] button	Outputs the "title block" or "end block".

- To output individual IDs, select and save the ID when editing templates.

Main objectives

- The GLP/GMP compliant data can be output to a PC or optional printer.
- The GLP/GMP compliant report includes the balance manufacturer (A&D), model name, serial number, ID number, date, time, and space for a signature. For a sensitivity adjustment or calibration test, the result and the weight used are also included.
- The balance can output the following GLP/GMP compliant reports via the connected external output.
- Sensitivity adjustment report
(Output for internal sensitivity adjustment, automatic sensitivity adjustment, external sensitivity adjustment)
- Calibration test report
(Output for calibration test using the internal weight or an external weight)
- Breaks ("title block" and "end block") for easy management of a series of weighing data

CAUTION

- When the application is in formulation mode or HPLC mode, GLP custom output is not available.

Output examples of internal sensitivity adjustment

- ❑ The GLP output when the sensitivity of the balance is adjusted using the internal weight is shown below.
- ❑ Clock to be used: Balance internal clock. Outputs data with the internal clock of the balance.

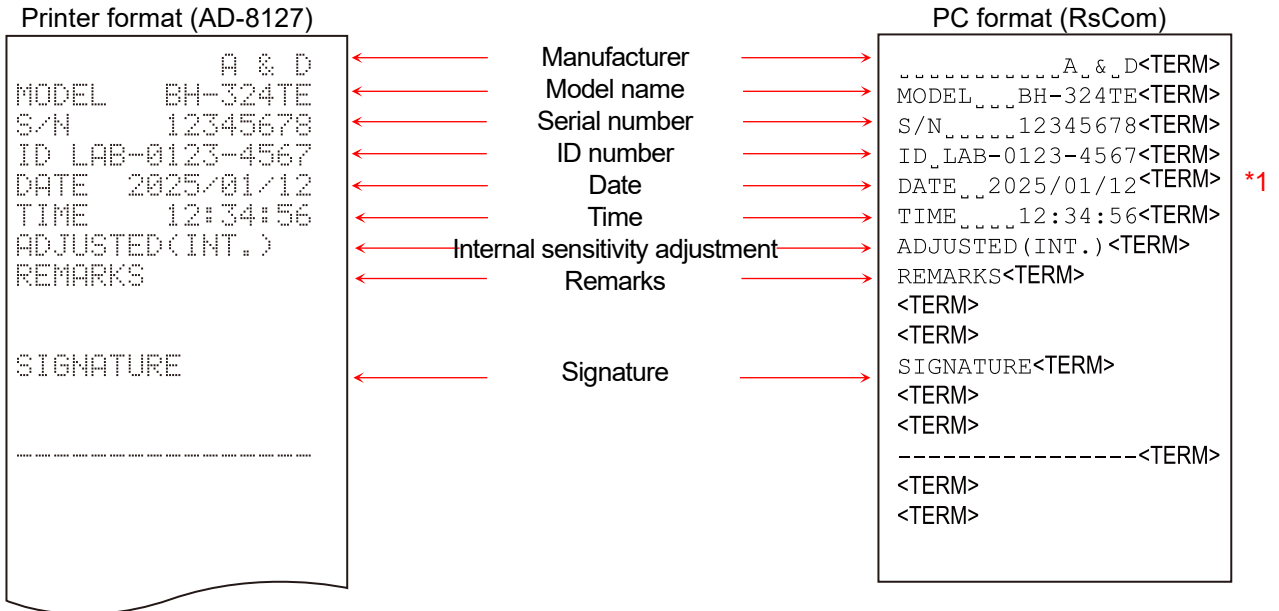

*1

- : Space, ASCII 20h
- <TERM> : Terminator, CR LF or CR
- CR : Carriage return, ASCII 0Dh
- LF : Line feed, ASCII 0Ah

*1 The output order of the year, month, and day varies depending on the destination region.

Outputting external device clock data (clock to be used: external device clock)

- By setting an external device clock for the clock to be used for outputting GLP/GMP data, you can use the clock data from an external device such as a PC or printer for the balance instead of the internal clock data. This setting is used to unify the clock data with the clock function of the external device.

CAUTION

- The clock data output from an external device can be used with a device that has a clock function and that can output the date and time in response to <ESC>D, <ESC>T. (AD-8127 multi-functional compact printer, AD-8129TH compact thermal printer, RsCom [WinCT] data communication software, etc.)

Output examples of internal calibration test

- The GLP output when the weighing accuracy of the balance is checked using the internal weight is shown below. (Note that sensitivity adjustment is not performed.)
- Clock to be used: Set to [External device clock]. Outputs clock data from an external device clock.

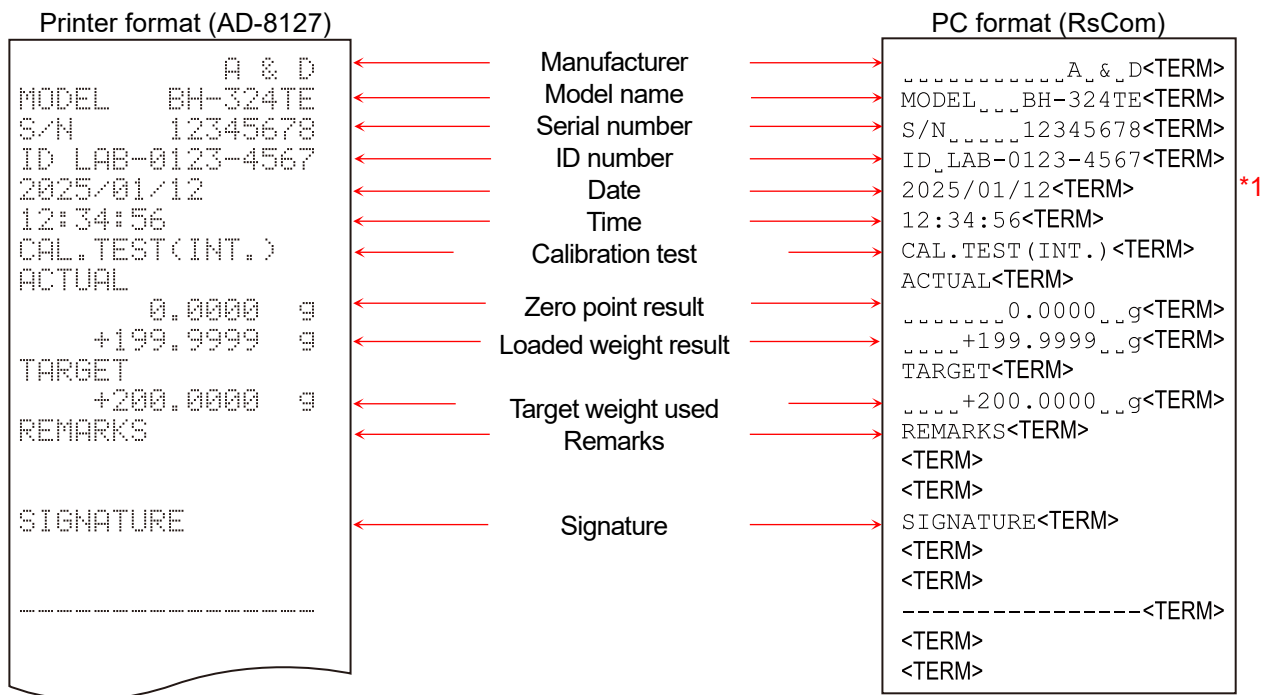

- : Space, ASCII 20h
- <TERM> : Terminator, CR LF or CR
- CR : Carriage return, ASCII 0Dh
- LF : Line feed, ASCII 0Ah

*1 The output order of the year, month, and day varies depending on the destination region.

Output examples of external sensitivity adjustment

- ❑ The GLP output when the sensitivity of the balance is adjusted using an external weight is shown below.
- ❑ Clock to be used: Balance internal clock. Outputs data with the internal clock of the balance.

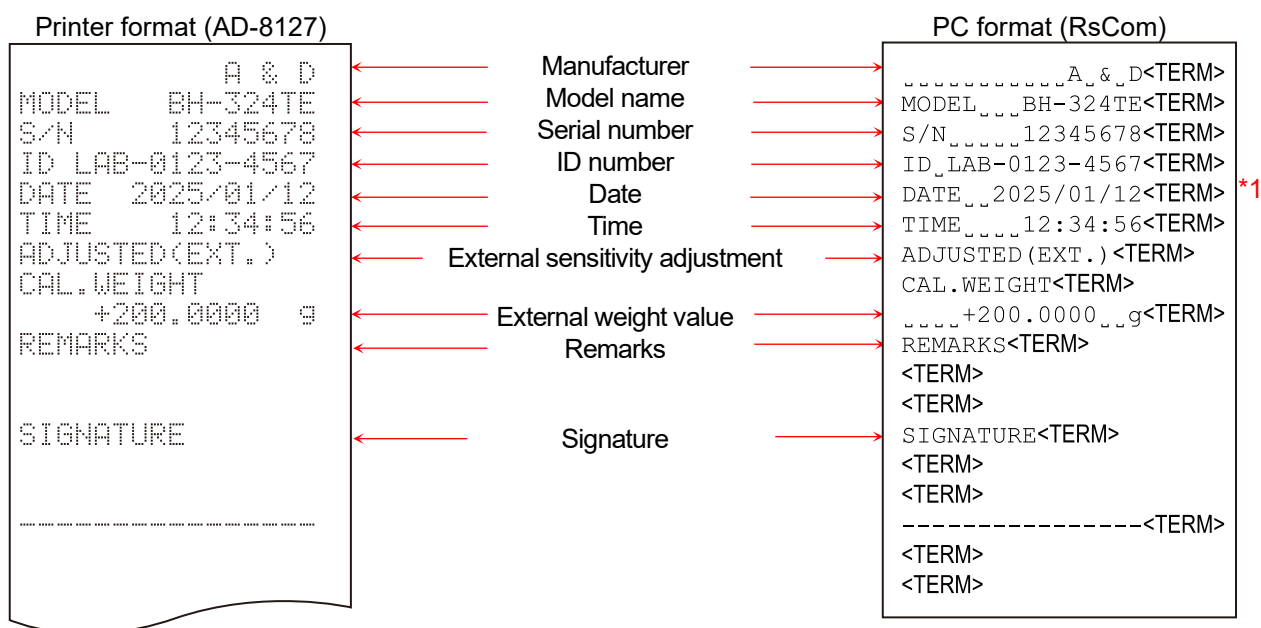

- : Space, ASCII 20h
- <TERM> : Terminator, CR LF or CR
- CR : Carriage return, ASCII 0Dh
- LF : Line feed, ASCII 0Ah

*1 The output order of the year, month, and day varies depending on the destination region.

Output examples of external calibration test

- ❑ The GLP output when the weighing accuracy of the balance is checked using an external weight is shown below. (No sensitivity adjustment is performed.)
- ❑ Clock to be used: Balance internal clock. Outputs data with the internal clock of the balance.

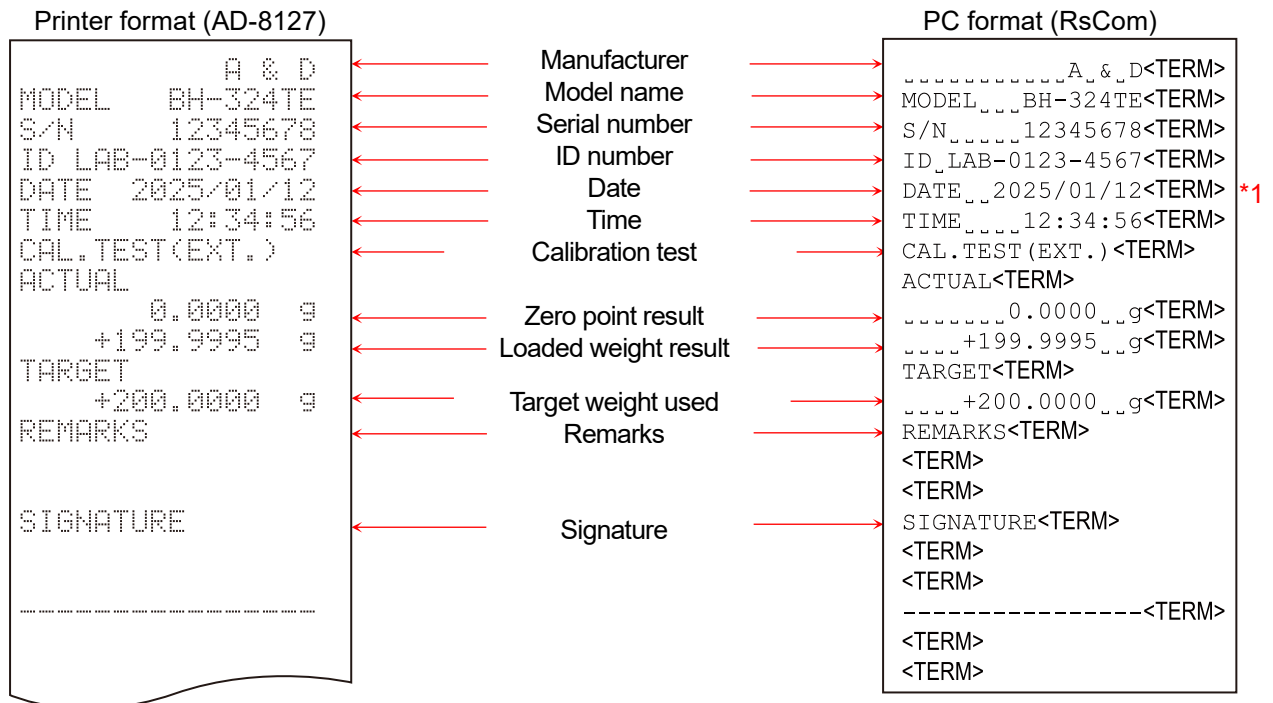

- : Space, ASCII 20h
- <TERM> : Terminator, CR LF or CR
- CR : Carriage return, ASCII 0Dh
- LF : Line feed, ASCII 0Ah

*1 The output order of the year, month, and day varies depending on the destination region.

Title block and End block

Application/operation

A "Title block" and "End block" can be added before and after a series of weighing values for data management.

Pressing the [GLP] button outputs the "Title block" and "End block" alternately.

Output method using the keys

Step	Description
1	In the weighing display, press the [GLP] button to output the title block.
2	Output the weighing value. The output method depends on the setting of the data output mode.
3	Press the [GLP] button to output the end block.

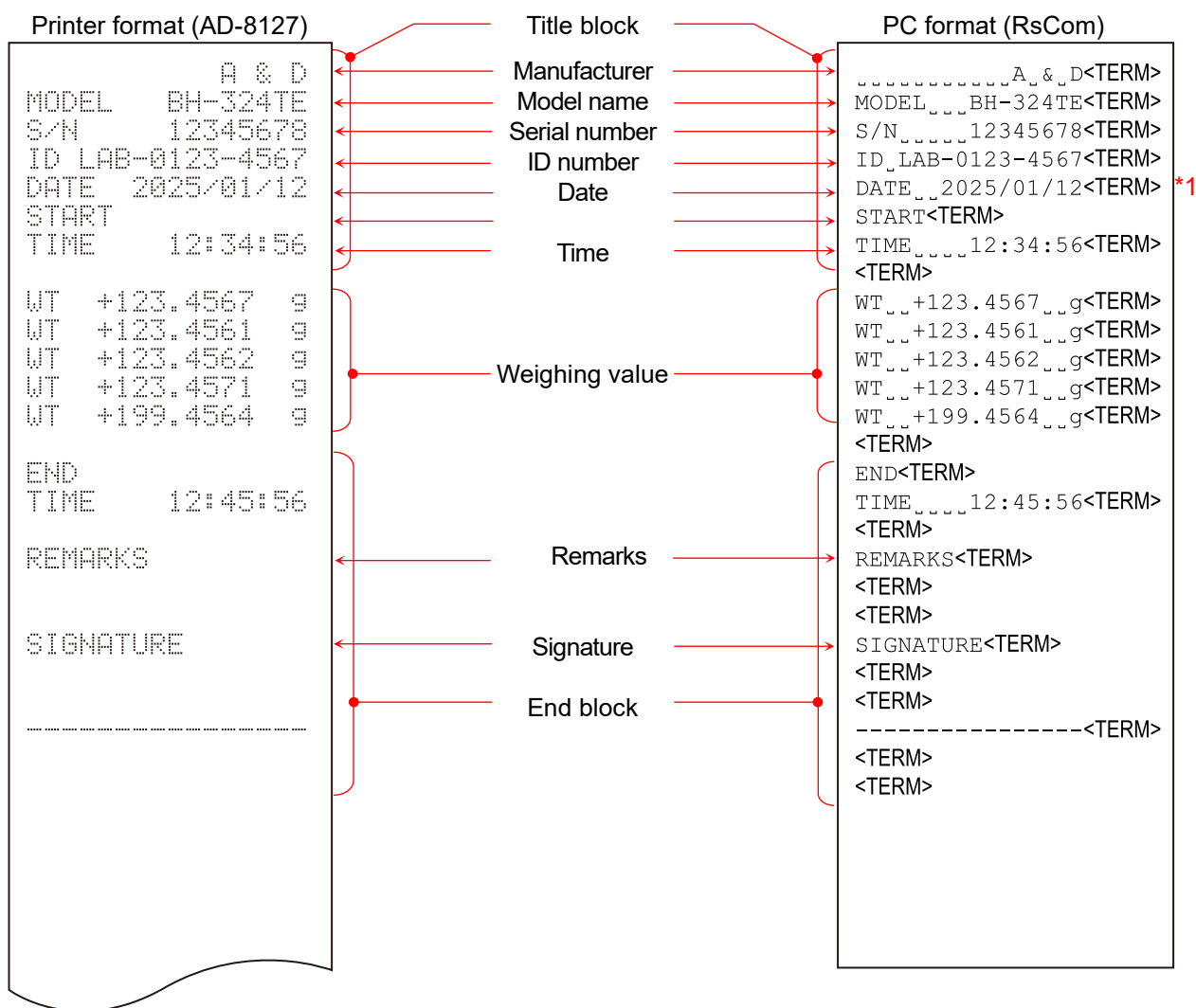

- : Space, ASCII 20h
- <TERM> : Terminator, CR LF or CR
- CR : Carriage return, ASCII 0Dh
- LF : Line feed, ASCII 0Ah





*1 The output order of the year, month, and day varies depending on the destination region.

13.14. GLP custom output

- By creating or editing an output template, you can output the content that you want when outputting weighing data.
- By creating or editing a header/footer, you can output the content that you want when outputting the "title block" or "end block".

CAUTION

- When the application is in formulation mode, HPLC mode or density measurement mode, GLP custom output is not available.

Display settings: [MENU] key  > [System Settings] button  > [Communication] button  > [GLP output/Label output] button  > In the [GLP output/Label output] setting screen, [GLP output/Label output] button > Select [GLP custom output].
[HOME] key  > [HOME] screen > [GLP] button > [GLP custom output mode] screen.



	Name	Description
(1)	[PRINT] button	Outputs the weighing data to the device connected to the balance. The output content will vary depending on the template selected.
(2)	[GLP] button	Displays the [GLP custom output mode] screen.
(3)	Template selected	Displays the template currently selected. The weighing data is output with the content of this template.
(4)	Content registered for ID	Displays the output content of each ID title and ID text. Touch this to change the content.
(5)	[Back] button	Returns to the [HOME] screen.
(6)	[Print header] button	Outputs the "title block". After that, returns to the [HOME] screen.
(7)	[Print footer] button	Outputs the "end block". After that, returns to the [HOME] screen.
(8)	[GLP setting] button	Displays the [GLP output/Label output] screen (" 13.12. GLP output/Label output ").
(9)	[Template] button	Displays the [Template] screen (" 13.14.1. Template ").





- To output individual IDs, select and save the ID when editing templates.

13.14.1. Template

- ❑ You can create, delete, or toggle templates in the [Template] screen.
- ❑ Templates created are saved in the internal memory of the balance. The data in the internal memory is retained even when the power of the balance is turned off.
- ❑ "SAMPLE001-T" is set for templates as the default setting.

CAUTION

- ❑ If the balance is initialized, templates created are erased and returned to the initial state.

Display settings: [MENU] key  > [System Settings] button  > [Communication] button  > [GLP output/Label output] button  :

In the [GLP output/Label output] setting screen, [GLP output/Label output] button > Select [GLP custom output].

In the [GLP output/Label output] setting screen, Edit [Template] button > [Template] screen.

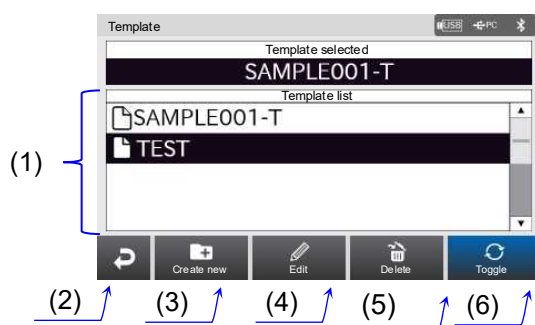

	Name	Description
(1)	Template list	You can check or select the template created. The template selected is displayed with a black background.
(2)	[Back] button	Returns to the previous screen.
(3)	[Create new] button	Displays a text box. A new template is created with the name entered in the text box.
(4)	[Edit] button	Navigates to the [Edit template] screen (" 13.14.2. Editing templates "). You can edit the output content of the template selected.
(5)	[Delete] button	Deletes the template selected.
(6)	[Toggle] button	Toggles between the template selected and the one being set.

- ❑ Up to 50 templates can be created.
- ❑ Up to 30 characters can be entered for the name of a template.
- ❑ A template with the same name as an existing template cannot be created.
- ❑ If a template is not selected, the [Edit] button, the [Delete] button, and the [Toggle] button becomes disabled.
- ❑ If a template is selected, the [Delete] button becomes disabled.
- ❑ If the data output mode of the balance is stream mode, regardless of the template being set, the weighing value only is output.

13.14.2. Editing templates

- ❑ In the [Edit template] screen, you can edit, rename, test print, or save templates.

Display settings: In the [Template] screen, select a template to edit and then press the [Edit] button > [Edit template] screen.

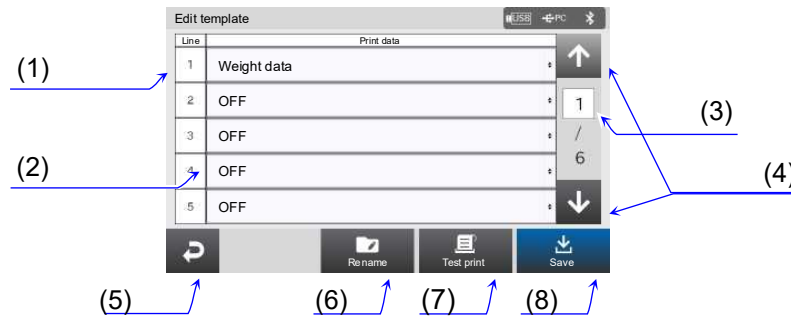

	Name	Description
(1)	Output line	The line where print data is output. Up to 30 lines can be set.
(2)	Print data	Displays data to be output. To select data, touch this field.
(3)	Page number	Displays the current page number. To display another page, touch the field and enter the page number.
(4)	[Page navigation] buttons	Navigates to the previous/next print data page.
(5)	[Back] button	Returns to the [Template] screen (" 13.14.1. Template ").
(6)	[Rename] button	Enables the name of the template selected to be changed.
(7)	[Test print] button	Outputs the current print data. You can check the output content.
(8)	[SAVE] button	Saves a template with the current print data.

- ❑ You cannot change a template name to that of an existing template with the [Rename] button.
- ❑ When outputting with the [Test print] button, connect the balance to a PC or a printer.
- ❑ If you leave the [Edit template] screen without touching the [SAVE] button, the content edited is not saved.

13.14.3. List of print data

Output data	Output examples
OFF	Nothing is to be output.
Date* ³	D A T E _ _ 2 0 2 5 / 0 1 / 2 3
Time	T I M E _ _ _ _ 1 2 : 3 4 : 5 6
Weight data	W T _ _ _ _ 2 3 . 4 5 6 7 _ _ g
Net weight	N _ _ _ _ 2 3 . 4 5 6 7 _ _ g
Tare weight	T _ _ _ _ 1 0 0 . 0 0 0 0 _ _ g
Gross weight	G _ _ _ _ 1 2 3 . 4 5 6 7 _ _ g
Quantity	Q T _ _ _ _ _ _ 1 2 3 4 _ P C
Unit weight	U W _ _ _ _ 1 2 . 3 4 5 6 _ _ g
Minimum weight	M W _ _ _ _ _ _ 2 0 0 . 0 _ m g
Manufacturer	_ _ _ _ _ _ _ _ _ _ A _ & _ D
Model name	M O D E L _ _ _ B H - 3 2 4 T E
Serial number	S / N _ _ _ _ T 1 2 3 4 5 6 7
ID number* ¹	I D _ S A M P L E - 1 2 3 4 - 5
User name* ²	U S E R _ N A M E A d m i n
User level	U S E R _ L E V E L A d m i n i s t r a t o r
Application name	W e i g h i n g
ID1 title* ¹	A r t i c l e _ N u m b e r
ID1 text* ¹	A A A A A B B B B B C C C C C D D D D D
ID2 title* ¹	P r o d u c t
ID2 text* ¹	A B C - 0 0 0 0 1
ID3 title* ¹	S a m p l e _ N a m e
ID3 text* ¹	0 1 2 3 4 5 - 0 0 0 0 1
ID4 title* ¹	L o t _ N u m b e r
ID4 text* ¹	0 1 2 3 4 5 - 0 0 0 0 1
Line break	Start a new line and moves to the next one.
Start	S T A R T
End	E N D
Remarks	R E M A R K S
Signature	S I G N A T U R E
Separator line (*)	* * * * * * * * * * * * * * * *
Separator line (-)	- - - - - - - - - - - - - - - -

*¹ Output changes depending on the content registered.

*² User name is not output unless logged in.

Set the output content to use only alphanumeric characters.

*³ The output order of the year, month, and day varies depending on the destination region.

13.14.4. Setting example of GLP custom output

As an example of output, the following template is created.

Template name: TEST

Output content



- 1st line: Sample name (Sample1)
- 2nd line: Time
- 3rd line: Weight data
- 4th line: Net weight
- 5th line: Tare weight

Example of printer format

```

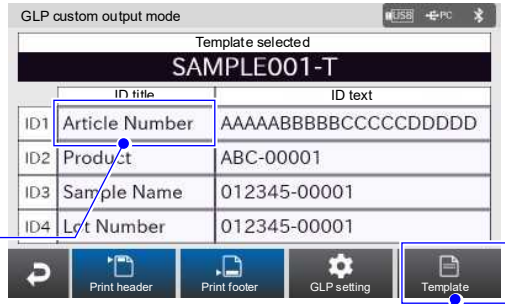
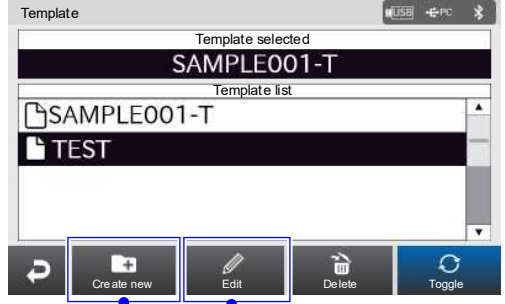

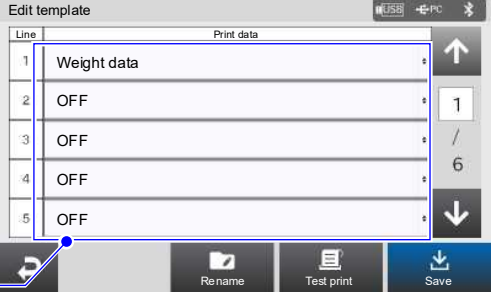
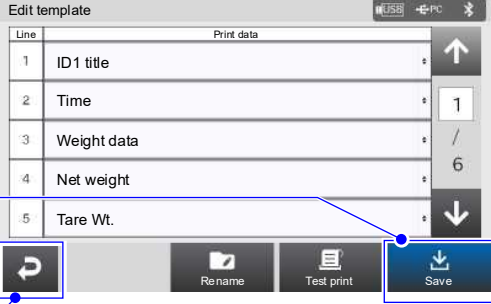
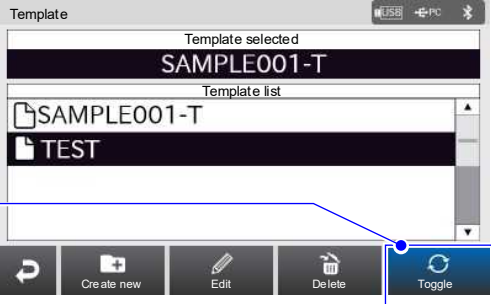

Sample1
TIME    12:34:56
WT      100.0000  g
N       100.0000  g
T       100.0000  g
    
```

Step	Description
1	<p>Set [GLP output/Label output] to [GLP custom output mode], and then go to the [HOME] screen. In the [HOME] screen, press the [GLP] button to go to the [GLP custom output mode] screen.</p>  <p>Press the [GLP] button</p>
2	<p>In the [GLP custom output mode] screen, change the ID1 title to "Sample1", which is to be output this time. After changing, press the [Template] button to go to the [Template] screen.</p>  <p>Change to Sample1</p> <p>Press the [Template] button</p>
3	<p>In the [Template] screen, press the [Create new] button, and then enter the template name "TEST". After entering, a template is created. Select "TEST" created, and then press the [Edit] button to go to the [Edit template] screen.</p>  <p>Press the [Create new] button, and then enter "TEST"</p> <p>Select "TEST", and then press the [Edit] button</p>

Step	Description
4	<p>In the [Edit template] screen, change the print data in each line depending on the content to output. This time, enter the ID1 title (Sample1), time, weight data, net weight, and tare weight in sequence from line 1.</p>  <p style="text-align: right;">Change the print data</p>
5	<p>After changing the print data, press the [SAVE] button. After saving it, press the [Back] button to return to the [Template] screen.</p>  <p style="text-align: center;">Press the [SAVE]</p> <p style="text-align: center;">Press the [Back] button</p>
6	<p>In the [Template] screen, select "TEST" in which the output content is saved this time, and then press the [Toggle] button. Pressing the [Toggle] button switches the template selected to "TEST".</p>  <p style="text-align: center;">Press the [Toggle] button</p>
7	<p>This is the end of setting procedures. Return to the [HOME] screen, and then press the [PRINT] button. Weighing data is output with the content saved.</p>  <p style="text-align: center;">Press the PRINT button</p>

13.14.5. Header

- ❑ In the [Header] screen, you can create, delete, or toggle headers.
- ❑ Headers created are saved in the internal memory of the balance. The data in the internal memory is retained even when the power of the balance is turned off.
- ❑ "SAMPLE001-H" is set for headers as the default setting.

Display settings: [MENU] key  > [System Settings] button  > [Communication] button  > [GLP output/Label output] button  :

In the [GLP output/Label output] screen, [GLP output/Label output] button > Select [GLP custom output].

In the [GLP output/Label output] setting screen, Edit header > [Header] screen.

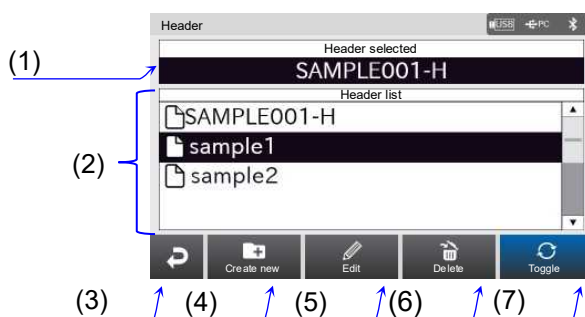

	Name	Description
(1)	Header selected	Displays the header currently selected. The "title block" is output with the content of this header.
(2)	Header list	You can check or select the header created. The header selected by touching is displayed with a black background.
(3)	[Back] button	Returns to the previous screen.
(4)	[Create new] button	Displays a text box. A new header is created with the name entered in the text box.
(5)	[Edit] button	Displays the [Edit header] screen (" 13.14.6. Editing headers "). You can edit the output content of the header selected.
(6)	[Delete] button	Deletes the header selected.
(7)	[Toggle] button	Toggles between the header selected and the one being set.

- ❑ Up to 50 headers can be created.
- ❑ Up to 30 characters can be entered for the name of a header.
- ❑ A header with the same name as an existing header cannot be created.
- ❑ If a header is not selected, the [Edit] button, the [Delete] button, and the [Toggle] button becomes disabled.
- ❑ If a header is selected, the [Delete] button becomes disabled.

13.14.6. Editing headers

- ❑ In the [Edit header] screen, you can edit, rename, test-print, or save headers.
- ❑ For printable data, refer to "13.14.3. List of print data".

Display settings: In the [Header] screen, select a header to edit and then the [Edit] button > [Edit header] screen.

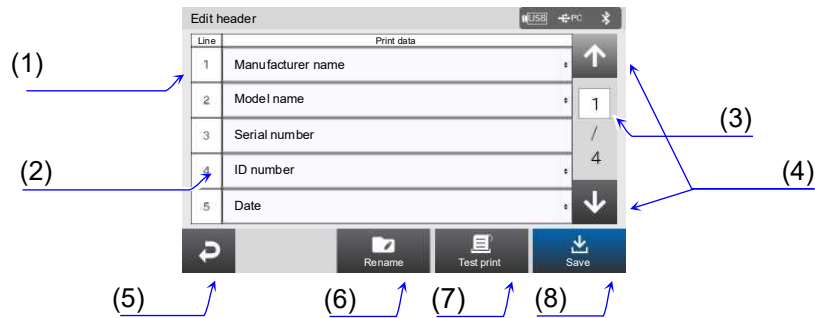

	Name	Description
(1)	Output line	The line where print data is output. Up to 20 lines can be set.
(2)	Print data	Displays data to be output. To select data, touch this field.
(3)	Page number	Displays the current page number. To display another page, touch the field and enter the page number.
(4)	[Page navigation] buttons	Navigates to the previous/next print data page.
(5)	[Back] button	Returns to the [Header] screen.
(6)	[Rename] button	Enables the name of the header selected to be changed.
(7)	[Test print] button	Outputs the current print data. You can check the output content.
(8)	[SAVE] button	Saves a header with the current print data.

- ❑ You cannot change a header name to that of an existing header with the [Rename] button.
- ❑ When outputting with the [Test print] button, connect the balance to a PC or a printer.
- ❑ If you leave the [Edit header] screen without touching the [SAVE] button, the content edited will not be saved.

13.14.7. Footer

- ❑ In the [Footer] screen, you can create, delete, or toggle footers.
- ❑ Footers created are saved in the internal memory of the balance. The data in the internal memory is retained even when the power of the balance is turned off.
- ❑ "SAMPLE001-F" is set for footers as the default setting.

Display settings: [MENU] key  > [System Settings] button  > [Communication] button  > [GLP output/Label output] button  :

In the [GLP output/Label output] screen, [GLP output/Label output] button > Select [GLP custom output].

In the [GLP output/Label output] screen, Edit footer > [Footer] screen.

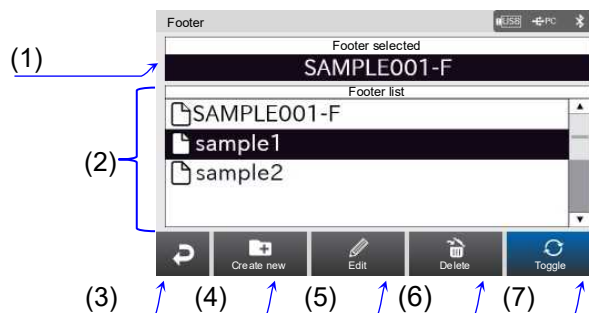

	Name	Description
(1)	Footer selected	Displays the footer currently selected. The "end block" is output with the content of this footer.
(2)	Footer list	You can check or select the footer created. The footer selected by touching is displayed with a black background.
(3)	[Back] button	Returns to the previous screen.
(4)	[Create new] button	Displays a text box. A new footer is created with the name entered in the text box.
(5)	[Edit] button	Displays the [Edit footer] screen (" 13.14.8. Editing footers "). You can edit the output content of the footer selected.
(6)	[Delete] button	Deletes the footer selected.
(7)	[Toggle] button	Toggles between the footer selected and the one being set.

- ❑ Up to 50 footers can be created.
- ❑ Up to 30 characters can be entered for the name of a footer.
- ❑ A footer with the same name as an existing footer cannot be created.
- ❑ If a footer is not selected, the [Edit] button, the [Delete] button, and the [Toggle] button becomes disabled.
- ❑ If a footer is selected, the [Delete] button becomes disabled.

13.14.8. Editing footers

- ❑ In the [Edit footer] screen, you can edit, rename, test-print, or save footers.
- ❑ For printable data, refer to "13.14.3. List of print data".

Display settings: In the [Footer] screen, select the footer to edit and then the [Edit] button > [Edit footer] screen.

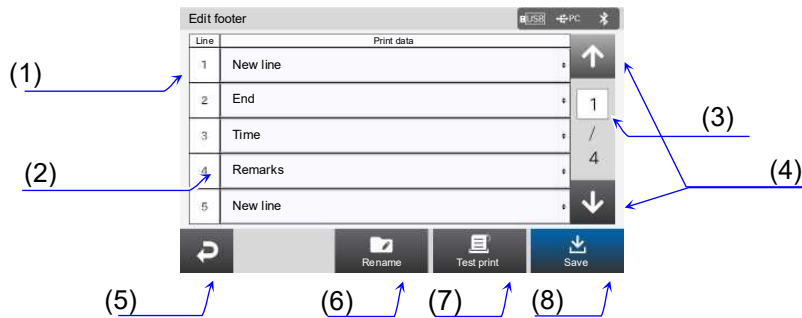

	Name	Description
(1)	Output line	The line where print data is output. Up to 20 lines can be set.
(2)	Print data	Displays data to be output. To select data, touch this field.
(3)	Page number	Displays the current page number. To display another page, touch the field and enter the page number.
(4)	[Page navigation] buttons	Navigates to the previous/next print data page.
(5)	[Back] button	Returns to the [Footer] screen ("13.14.7. Footer").
(6)	[Rename] button	Enables the name of the footer selected to be changed.
(7)	[Test print] button	Outputs the current print data. You can check the output content.
(8)	[SAVE] button	Saves footer with the current print data.





- ❑ You cannot change a footer name to that of an existing footer with the [Rename] button.
- ❑ When outputting with the [Test print] button, connect the balance to a PC or a printer.
- ❑ If you leave the [Edit footer] screen without touching the [SAVE] button, the content edited will not be saved.

13.15. Label output

- ❑ You can output weighing data as a barcode (CODE128) by connecting the balance to a label printer.
- ❑ By creating or editing an output template, you can output the content you want.

CAUTION

- ❑ Connect the balance to a label printer that supports the program languages ZPL® and ZPLII®.
- ❑ When the application is in formulation mode or HPLC mode, label output is not available.

Display settings: [MENU] key  > [System Settings] button  > [Communication] button  > [GLP output/Label output] button  > In the [GLP output/Label output] setting screen, [GLP output/Label output] button > Select [Label output].

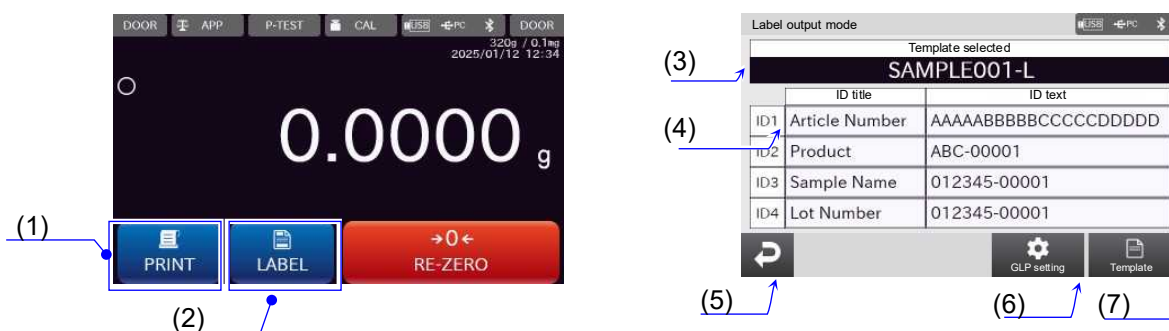

	Name	Description
(1)	[PRINT] button	Outputs the weighing data to the device connected to the balance. The output content will vary depending on the template selected.
(2)	[LABEL] button	Displays the [Label output mode] screen.
(3)	Template selected	Displays the template currently selected. The data is output with the content of this template. "SAMPLE001-L" is set as the default setting.
(4)	Content registered for ID	Displays the output content of each ID title and ID text. Touch this to change the content.
(5)	[Back] button	Returns to the [HOME] screen.
(6)	[GLP setting] button	Displays the [GLP output/Label output] screen (" 13.12. GLP output/Label output ").
(7)	[Template] button	Displays the [Template] screen (" 13.15.1. Template ").





- ❑ The content registered for the ID is common to GLP custom output.





13.15.1. Template

- ❑ In the [Template] screen, you can create, delete, or toggle templates.
- ❑ Templates created are saved in the internal memory of the balance. The data in the internal memory is retained even when the power of the balance is turned off.
- ❑ "SAMPLE001-L" is set for templates as the default setting.

CAUTION

- ❑ If the balance is initialized, templates created are erased and returned to the initial state.

Display settings: [MENU] key  > [System Settings] button  > [Communication] button  > [GLP output/Label output] button  > In the [GLP output/Label output] setting screen, [GLP output/Label output] button > Select [Label output].

[MENU] key  > System setting button  > [Communication] button  > [GLP output/Label output] button  > In the [GLP output/Label output] setting screen, Edit [Template] button > [Template] screen.

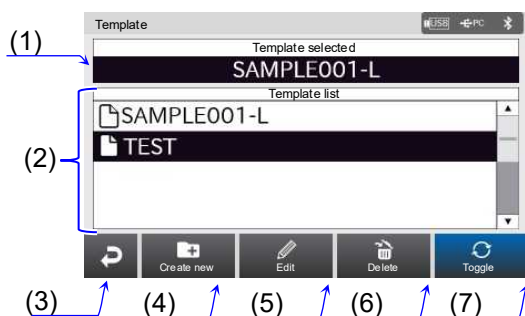

	Name	Description
(1)	Template selected	Displays the template currently selected. The weighing data is output with the content of this template.
(2)	Template list	You can check or select the template created. The template selected is displayed with a black background.
(3)	[Back] button	Returns to the previous screen.
(4)	[Create new] button	Displays a text box. A new template is created with the name entered in the text box.
(5)	[Edit] button	Navigates to the [Edit template] screen (" 13.15.2. Editing templates "). You can edit the output content of the template selected.
(6)	[Delete] button	Deletes the template selected.
(7)	[Toggle] button	Toggles between the template selected and the one being set.

- ❑ Up to 50 templates can be created.
- ❑ Up to 30 characters can be entered for the name of a template.
- ❑ A template with the same name as an existing template cannot be created.
- ❑ If a template is not selected, the [Edit] button, the [Delete] button, and the [Toggle] button become disabled.
- ❑ If a template is selected, the [Delete] button becomes disabled.
- ❑ If the data output mode of the balance is stream mode, regardless of the template being set, the weighing value only is output.

13.15.2. Editing templates

- ❑ In the [Edit template] screen, you can edit, rename, test-print, or save templates.
- ❑ For printable data, refer to "13.14.3. List of print data".

Display settings: In the [Template] screen, select the template to edit and then the [Edit] button > [Edit template] screen.

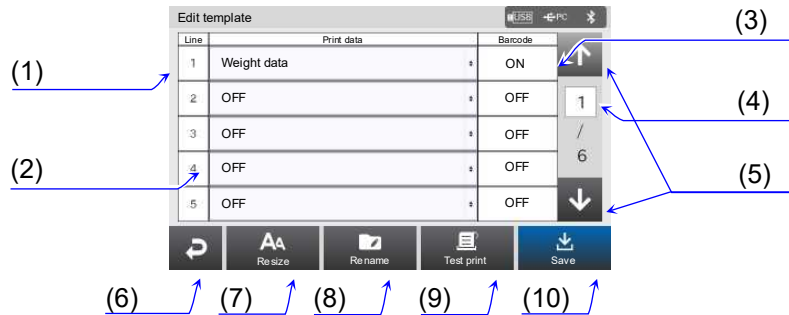

	Name	Description
(1)	Output line	The line where print data is output. Up to 30 lines can be set.
(2)	Print data	Displays data to be output. To select data, touch this field.
(3)	Barcode ON/OFF	A line set to ON is output as a barcode. A line set to OFF is output as texts.
(4)	Page number	Displays the current page number. To display another page, touch the field and enter the page number. You can also use the arrow buttons to move between pages.
(5)	[Page navigation] buttons	Navigates to the previous/next print data page.
(6)	[Back] button	Returns to the [Template] screen ("13.15.1. Template").
(7)	[Resize] button	Navigates to the [Resize] screen ("13.15.3. Resizing").
(8)	[Rename] button	Enables the name of the template selected to be changed.
(9)	[Test print] button	Outputs the current print data. You can check the output content.
(10)	[SAVE] button	Saves a template with the current print data.

- ❑ You cannot change a template name to that of an existing template with the [Rename] button.
- ❑ When outputting with the [Test print] button, connect the balance to a PC or a printer.
- ❑ If you leave the [Edit template] screen without touching the [SAVE] button, the content edited is not saved.

13.15.3. Resizing

- ❑ In the [Resize] screen, you can change the size of characters for templates selected and the size of barcodes.

Display settings: In the [Edit template] screen, [Resize] button > [Edit template] screen.



	Name	Description
(1)	Label print size button	To change the size of characters and barcodes to print, touch this button. There are four 4 sizes: "Small, Medium, Large, or Extra Large".
(2)	[Back] button	Returns to the [Edit template] screen (" 13.15.2. Editing templates ").

- ❑ As a guide to the sizes, refer to the following table.

	Small	Medium	Large	Extra large
Paper size/width	40 mm	60 mm	80 mm	100 mm
Character width	1 mm	2 mm	2.25 mm	3.25 mm
Character height	2 mm	4 mm	4.25 mm	5 mm
Barcode height	4 mm	5 mm	7 mm	9 mm

CAUTION

- ❑ Each size indicates the size when the printer resolution is 8 dpm (203 dpi).

13.15.4. Setting example for label output

The example below shows how to create the following template.

Template name: TEST



Output content

- 1st line: Sample name (Sample1)
- 2nd line: Date
- 3rd line: Time
- 4th line: Weight data (Barcode ON)

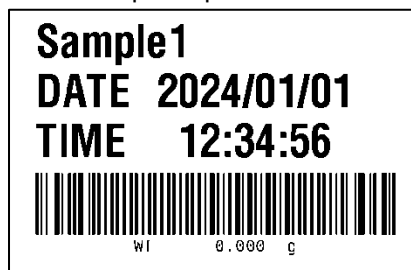
Example of printer format

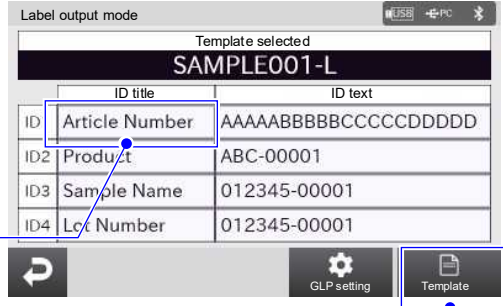
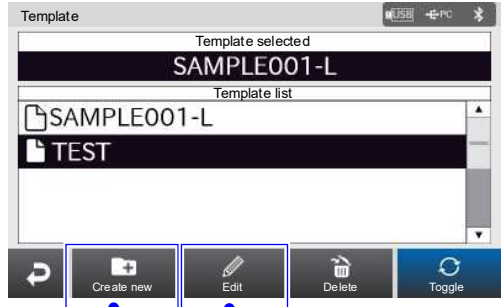

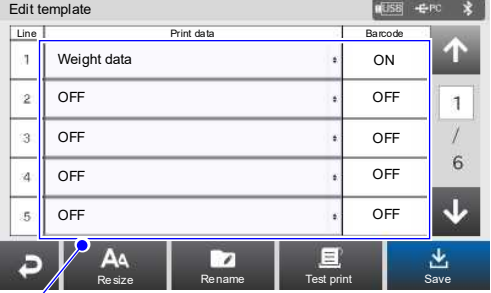
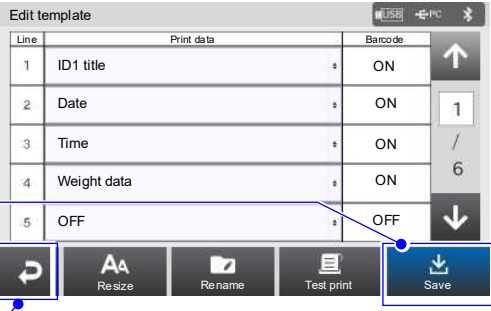
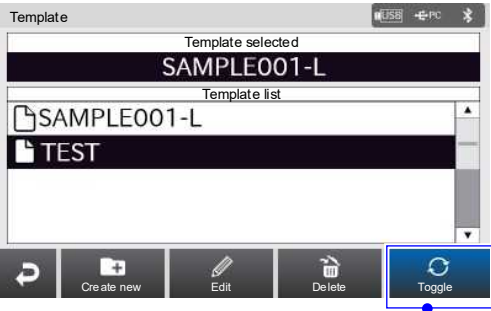
Step	Description
1	<p>Set [GLP output/Label output] to [Label output], and then go to the [HOME] screen. In the [HOME] screen, press the [LABEL] button to go to the [Label output mode] screen.</p>  <p style="text-align: center;">Press the [LABEL] button</p>
2	<p>In the [Label output mode] screen, change the ID1 title to "Sample1", which will be output this time. After changing, press the [Template] button to go to the [Template] screen.</p>  <p style="text-align: center;">Change to Sample1</p> <p style="text-align: center;">Press the [Template] button</p>
3	<p>In the [Template] screen, press the [Create new] button, and then enter the template name "TEST". After entering, a template is created. Select "TEST" created, and then press the [Edit] button to go to the [Edit template] screen.</p>  <p style="text-align: center;">Press the [Create new] button, and then enter "TEST"</p> <p style="text-align: center;">Select "TEST", and then press the [Edit] button</p>

Step	Description
4	<p>In the [Edit template] screen, change the print data in each line depending on the content to output. This time, input the ID title (Sample1), time, date, and weight data in sequence from line 1. Also, change ON/OFF for the barcode.</p>  <p style="text-align: right;">Change the print data</p>
5	<p>After changing the print data, press the [SAVE] button. After saving it, press the [Back] button to return to the [Template] screen.</p>  <p style="text-align: right;">Press the [SAVE]</p> <p style="text-align: right;">Press the [Back] button</p>
6	<p>In the [Template] screen, select "TEST" in which the output content is saved this time, and then press the [Toggle] button. Pressing the [Toggle] button switches the template selected to "TEST".</p>  <p style="text-align: right;">Press the [Toggle] button</p>
7	<p>This is the end of setting procedures. Return to the [HOME] screen, and then press the [PRINT] button. Weighing data is output with the content saved.</p>  <p style="text-align: right;">Press the [PRINT] button</p>

13.16. RS-232C interface

Display settings: [MENU] key  > [System Settings] button  > [Communication] button  > [RS-232C interface] button  > [RS-232C interface] screen.

(1) Baud rate

(2) Data bit, parity bit

(3) Data format

(4) [Back] button

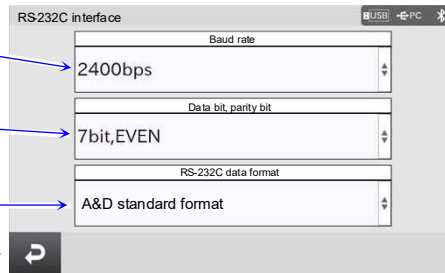



	Name	Setting value (setting range)	Description
(1)	Baud rate	600 bps, 1200 bps, 2400 bps , 4800 bps, 9600 bps, 19200 bps, 38400 bps	Selects the baud rate for the serial communication.
(2)	Data bit, parity bit	7 bits, even 7 bits, odd 8 bits, none	Selects the bit length and parity bit for the serial communication.
(3)	Data format	A&D standard format , DP format, KF format, MT format, NU format, NU2 format, CSV format, TAB format, UFC format	You can select the data format.
(4)	[Back] button	-	Returns to the previous screen.

Settings in the red box are default values (factory settings).

- For specifications, refer to "[15.1. RS-232C specifications](#)".
- For details on the data format, refer to "[19.2. Weighing data format](#)".

13.17. USB interface

Display settings: [MENU] key  > [System Settings] button  > [Communication] button  > [USB interface] button  > [USB interface] screen.

(1) USB device mode

(2) Data format

(3) [Format the USB flash drive] button

(4) [Back] button

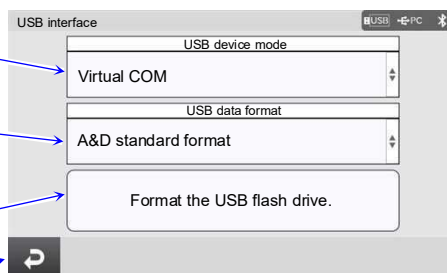





	Name	Setting value (setting range)	Description
(1)	USB device mode	Quick USB USB Virtual COM	Selects the connection method when the USB cable is used.
(2)	Data format	A&D standard format DP format KF format MT format NU format NU2 format CSV format TAB format UFC format	You can select the data format. Only available when using USB Virtual COM mode.*1
(3)	[Format the USB flash drive] button	-	Format the USB flash drive.
(4)	[Back] button	-	Returns to the previous screen.

 Settings in the red box are default values (factory settings).

- ❑ To connect the balance with your PC, you can select from the Quick USB mode and USB Virtual COM mode. For details, refer to "[18. Connecting to a PC](#)".
- ❑ For specifications, refer to "[15.2. USB specifications](#)".
- ❑ For details on the data format, refer to "[19.2. Weighing data format](#)".

*1 The data format is fixed to NU2 format when using Quick USB mode.

13.18. Wired LAN port

Display settings: [MENU] key  > [System Settings] button  > [Communication] button  > [Wired LAN] button  > [Wired LAN] screen.

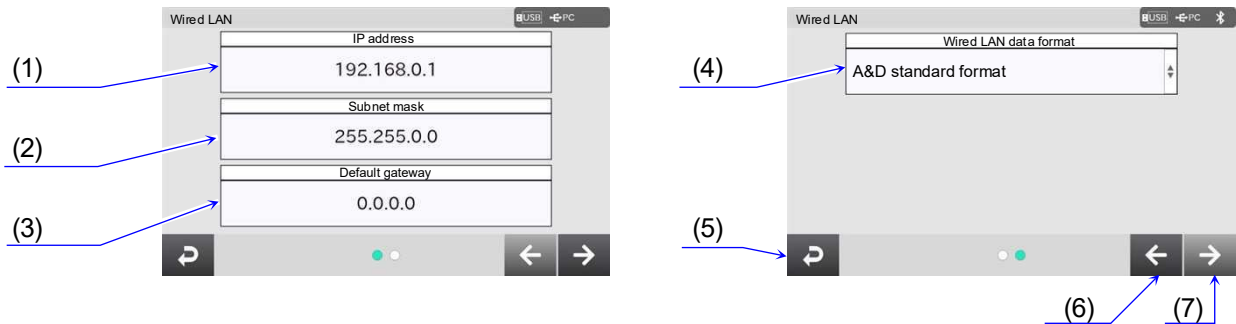

	Name	Setting value (setting range)	Description
(1)	IP address	For setting values, contact your LAN administrator.	Displays the IP address of the balance.
(2)	Subnet mask		Displays the subnet mask of the balance.
(3)	Default gateway		Displays the default gateway of the balance.
(4)	Data format	A&D standard format, DP format, KF format, MT format, NU format, NU2 format, CSV format, TAB format, UFC format	You can select the data format.
(5)	[Back] button	-	Returns to the previous screen.
(6)	[Previous] button	-	Returns to the previous screen.
(7)	[Next] button	-	Transitions to the next screen.





A&D standard format Settings in the red box are default values (factory settings).

- ❑ Refer to "[15.5. Wired LAN specifications](#)".
- ❑ For details on the data format, refer to "[19.2. Weighing data format](#)".

Cautions on the wired LAN

- ❑ For information about the connection to your local area network (LAN), contact your system administrator.

13.19. Bluetooth

Display settings: [MENU] key  > [System Settings] button  > [Communication] button  > [Bluetooth] button  > [Bluetooth] screen.

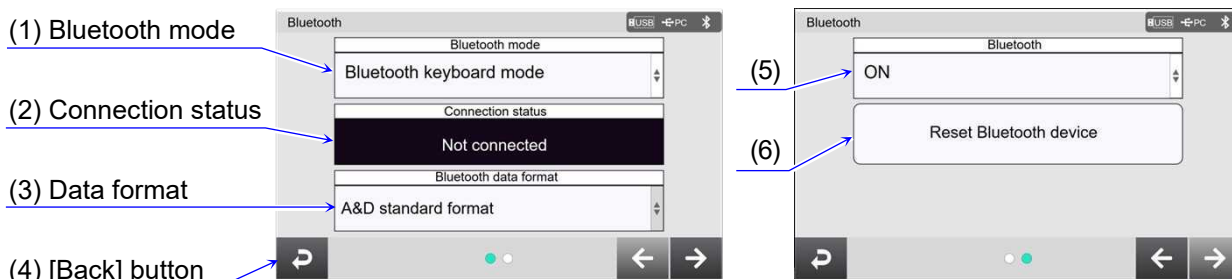





	Name	Setting value (setting range)	Description
(1)	Bluetooth mode	Bluetooth keyboard mode, Bluetooth serial mode	You can change the communication mode.
(2)	Connection status	-	The connection status is displayed.
(3)	Data format	A&D standard format, DP format, KF format, MT format, NU format, NU2 format, CSV format, TAB format, UFC format	You can select the data format. (This applies when the Bluetooth mode is set to [Bluetooth serial mode].)
(4)	[Back] button	-	Returns to the previous screen.
(5)	Bluetooth	ON, OFF	Switch of the bluetooth function
(6)	Bluetooth device RESET button	-	Reset switch of the bluetooth function

 Settings in the red box are default values (factory settings).

Caution on Bluetooth

- ❑ Bluetooth keyboard mode:
 - Use a Bluetooth-enabled device (such as a PC or smartphone) to perform pairing.
 - In Bluetooth keyboard mode, communication is one way from the balance to the Bluetooth-enabled device.
 - Only numerical values that represent weighing values are output.
 - Ensure the input of Bluetooth-enabled devices is set to single-byte alphanumeric characters.
- ❑ Bluetooth serial mode:
 - You can use the PC connection dongle AD8541-PC to enable two-way communication where commands are sent from your PC.
 - This connection allows WinCT, etc. to communicate.
- ❑ For details on the data format, refer to "[19.2. Weighing data format](#)".

13.20. UFC format

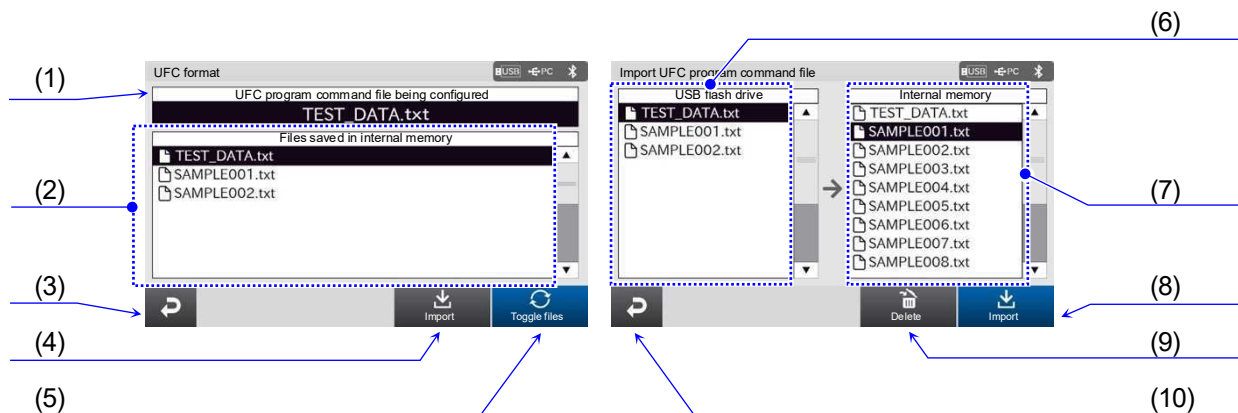

Display settings: [MENU] key  > [System Settings] button  > [Communication] button  > [UFC format] button  > [UFC format] screen.



	Name	Description
(1)	UFC program command file being configured	Displays the UFC program command file being configured.
(2)	Files saved in internal memory	You can view or select the UFC program command files stored in the balance's memory.
(3)	[Back] button	Displays the [Communication] screen ("13.6. Communication").
(4)	[Import] button	Displays the [Import UFC program command file] screen. Can be used only when a USB flash drive is connected.
(5)	[Toggle files] button	Switches the UFC program command file being set to the file currently selected from the file list in the internal memory. Can be used only when a file is selected.
(6)	USB flash drive file list	You can view or select the UFC program command files stored in the USB flash drive. Only ".txt" format files are displayed.
(7)	Files saved in internal memory	Displays the UFC program command files stored in the internal memory.
(8)	[Import] button	<ul style="list-style-type: none"> <input type="checkbox"/> Imports the UFC program command file selected in the USB flash drive file list to the internal memory. Can be used only when a file is selected. <input type="checkbox"/> Up to 50 files can be imported. <input type="checkbox"/> Files cannot be imported if the following applies. <ul style="list-style-type: none"> ■ The number of characters in the program command exceeds 1024 characters. ■ The three characters "PF," are missing at the beginning of the program command. ■ Another existing imported file has the same filename. ■ The filename has characters other than ASCII code. ■ The filename has the following characters: (), . - / ! ¥. ■ The filename is longer than 85 characters.
(9)	[Delete] button	Deletes the file selected in the UFC program command file list in the internal memory. Can be used only when a file is selected. The file being configured cannot be deleted.
(10)	[Back] button	Displays the [UFC format] screen.

- The UFC (Universal Flex Coms) function allows you to output contents of your choice when outputting the weighing data. For details, refer to "21. UFC Function".

13.21. Language

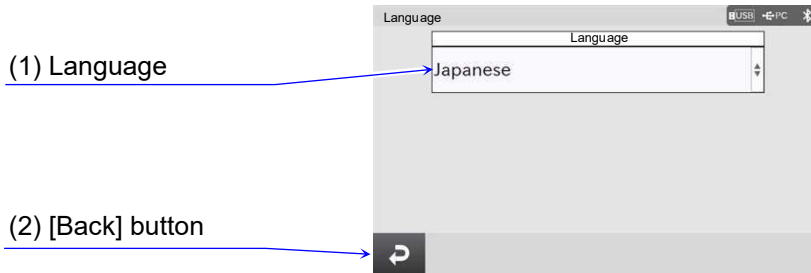

Display settings: [MENU] key  > [System Settings] button  > [Language] button  > [Language] screen.



	Name	Setting value (setting range)	Description
(1)	Language	Japanese, English , Korean, Russian, Chinese, Spanish, German, French, Italian, Dutch, Portuguese	Selects the language used for the display.
(2)	[Back] button	-	Returns to the previous screen.

Settings in the red box are default values (factory settings).

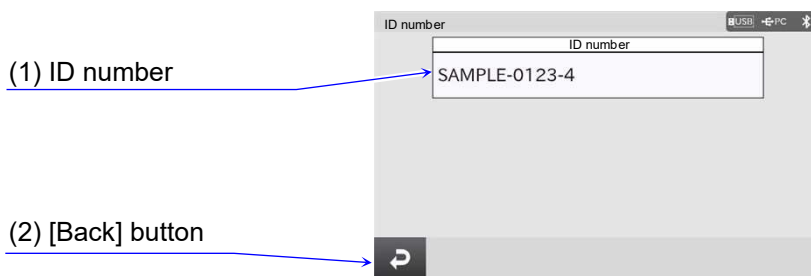

13.22. ID number settings

Display settings: [MENU] key  > [System Settings] button  > [ID number] button > [ID number] settings screen.



	Name	Description
(1)	ID number	You can set an ID number of your choice.
(2)	[Back] button	Returns to the previous screen.

13.23. External input switch

Display settings: [MENU] key  > [System Settings] button  > [External input switch] button  > [External input switch settings] screen.

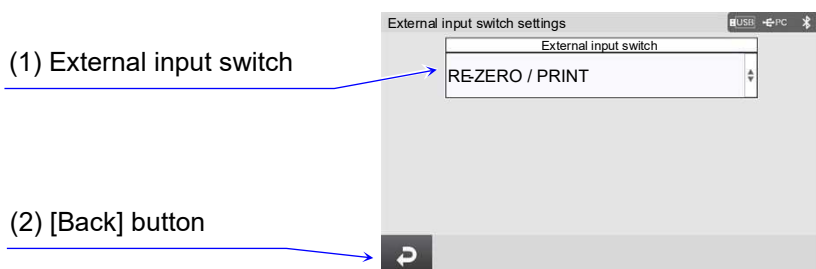



	Name	Setting value (setting range)	Description
(1)	External input switch	RE-ZERO/PRINT, Breeze break door(s)	You can change the settings for the function of connected external switches.
(2)	[Back] button	-	Returns to the previous screen.

 Settings in the red box are default values (factory settings).

- You can change the function of connected external switches such as a foot switch in the device settings screen.
These settings allow you to perform operations from external switches.
- For usage details and specifications, refer to "[15.4. External input terminal \(external input switch\)](#)".

13.24. Initialization



Display settings: [MENU] key  > [System Settings] button  > [Initialization] button  > Perform initialization.

- Resets the various settings for the balance to the factory settings. The data to be initialized are as follows.
 - Sensitivity adjustment data
 - Weight values for the sensitivity adjustment and calibration test on an external weight
 - Setting values in the function table
 - Standard values for check functions
 - Unit weight in the Counting mode
 - 100% reference mass in the Percent weighing mode
 - UFC program command file
- Items that remain unchanged even if you perform initialization are as follows.
 - Registered users, user authorization
 - Date/time
 - History (login/logout, operation history, sensitivity adjustment history)
 - Balance information and software version

CAUTION

- After initialization, ensure to perform the sensitivity adjustment.
- After initialization, the order of year, month, and day may change.

13.25. Balance status

Display settings: [MENU] key  > [Information] button  > [Balance status] screen.

(1) [Balance Information] button

(2) [Software version] button

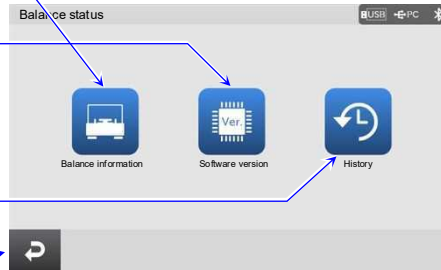

(3) [History] button

(4) [Back] button



	Name	Description
(1)	[Balance Information] button	Displays the [Balance information] screen (" 13.26. Balance information ").
(2)	[Software version] button	Displays the [Software version] screen (" 13.27. Software version ").
(3)	[History] button	Displays the [History] screen (" 13.28. History ").
(4)	[Back] button	Returns to the previous screen.

13.26. Balance information

Display settings: [MENU] key  > [Information] button  > [Balance Information] button  > [Balance information] screen.

(1) Model name

(2) Weighing capacity

(3) Readability

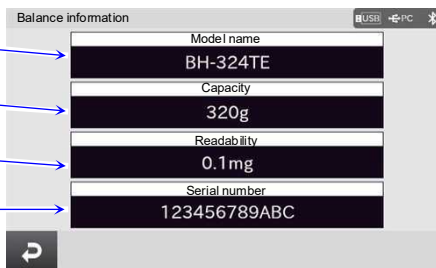

(4) Serial number

(5) [Back] button



	Name	Description
(1)	Model name	Displays the model name.
(2)	Weighing capacity	Displays the capacity.
(3)	Readability	Displays the readability (scale interval).
(4)	Serial number	Displays the serial number.
(5)	[Back] button	Returns to the previous screen.

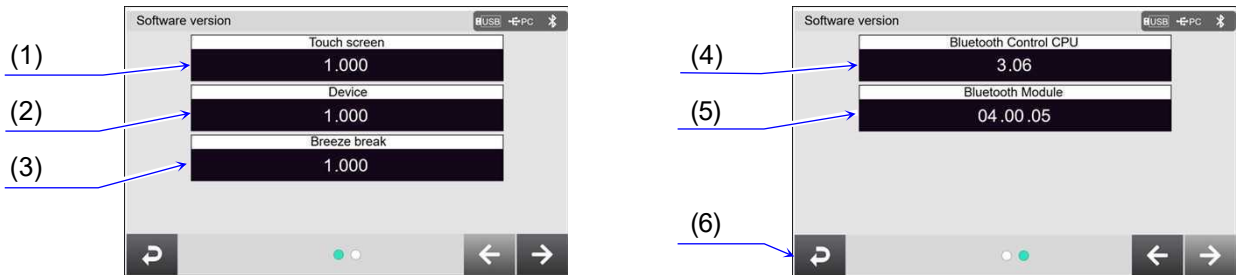

13.27. Software version

Display settings: [MENU] key  > [Information] button  > [Software version] button  > [Software version] screen.



	Name	Description
(1)	Touch screen	Display the software version of each function used for the balance.
(2)	Device	
(3)	Breeze break	
(4)	Bluetooth CPU control	Display the software version of each function used for the balance.
(5)	Bluetooth module	
(6)	[Back] button	Returns to the previous screen.



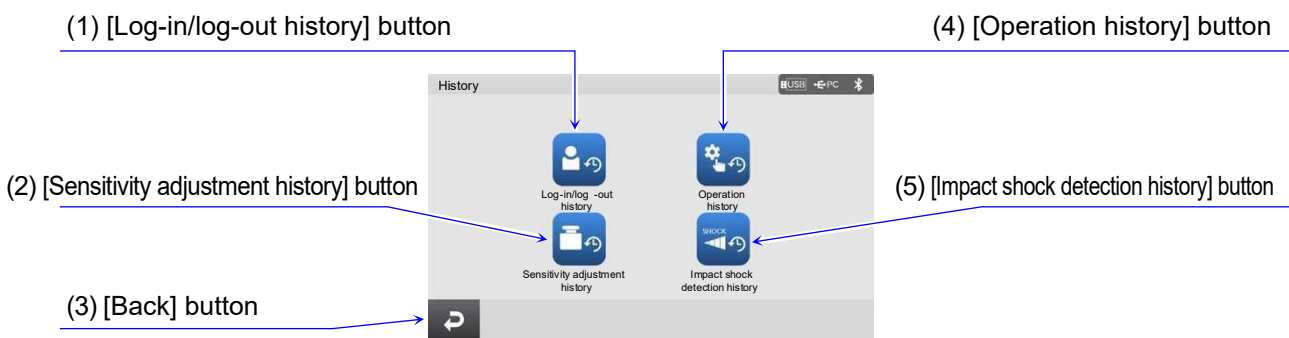

13.28. History

Display settings: [MENU] key  > [Information] button  > [History] button  > [History] screen.



	Name	Description
(1)	[Log-in/log-out history] button	Displays the [Log-in/log-out history] screen (" 13.29. Log-in/log-out history ").
(2)	[Sensitivity adjustment history] button	Displays the [Sensitivity adjustment history] screen (" 13.31. Sensitivity adjustment history ").
(3)	[Back] button	Returns to the previous screen.
(4)	[Operation history] button	Displays the [Operation history] screen (" 13.30. Operation history ").
(5)	[Impact shock detection history] button	Displays the [Impact shock detection history] screen (" 13.32. Impact shock detection history ").

13.29. Log-in/log-out history

Display settings: [MENU] key  > [Information] button  > [History] button  > [Log-in/log-out history] button  > [Log-in/log-out history] screen.

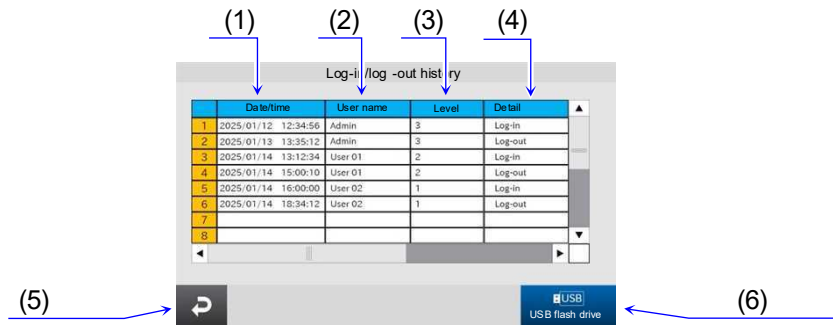

	Name	Description
(1)	Date/time	Displays the time when log-in/log-out operations were detected.
(2)	User name	Displays the user that performed the detected log-in/log-out operation.
(3)	Level	Displays the user level of the user that performed the log-in/log-out operation. 0: Operator 1: Supervisor 2: Lab manager 3: Administrator
(4)	Details	Displays "Log-in" or "Log-out".
(5)	[Back] button	Returns to the previous screen.
(6)	USB output	Outputs the history to the USB flash drive as a CSV file.

- The history function saves data only in English.
- Up to the latest 100 history records are displayed.
- Up to the latest 1000 history records are stored and can be output to the USB flash drive as a CSV file.
- If the history exceeds 1000 records, the oldest record is deleted and the latest record is added.

13.30. Operation history

Display settings: [MENU] key  > [Information] button  > [History] button  > [Operation history] button  > [Operation history] screen.

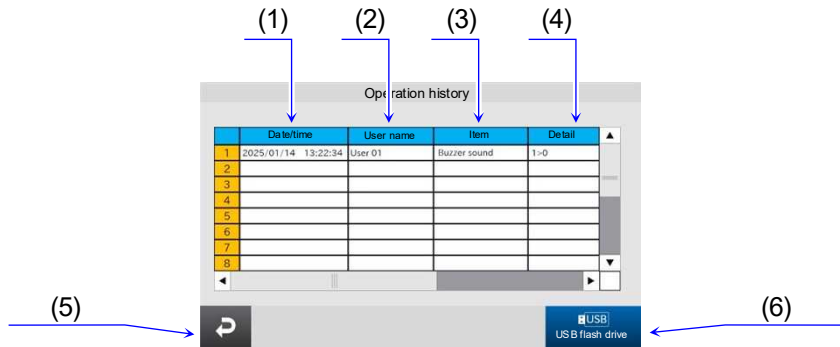

	Name	Description
(1)	Date/time	Displays the date and time when settings were changed.
(2)	User name	Displays the logged in user when the operation was detected.
(3)	Item	Displays the item for which settings were changed.
(4)	Details	Displays the details of how settings were changed.
(5)	[Back] button	Returns to the previous screen.
(6)	USB output	Outputs the history to the USB flash drive as a CSV file.



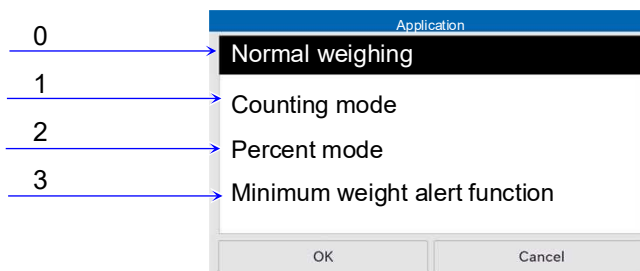

- The history function saves data only in English.
- Up to the latest 100 history records are displayed.
- Up to the latest 1000 history records are stored and can be output to the USB flash drive as a CSV file.
- If the history exceeds 1000 records, the oldest record is deleted and the latest record is added.

Note: Values in the Detail for the operation history represent the selection in the displayed order.

For example, in [Application] below, 0 represents the first selection from the top, 1 the second selection, 2 the third selection and 3 the fourth selection.



13.31. Sensitivity adjustment history



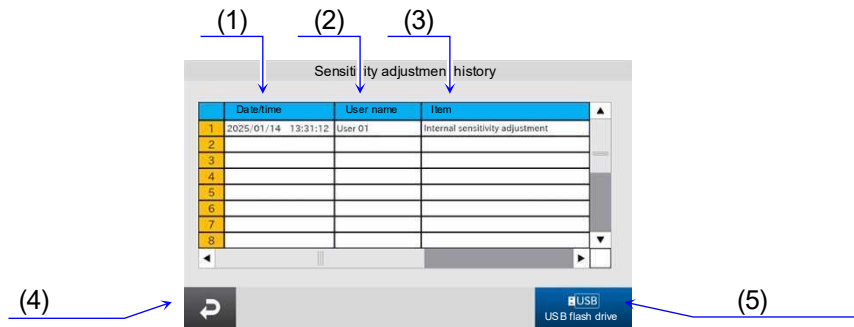

Display settings: [MENU] key  > [Information] button  > [History] button  > [Sensitivity adjustment history] button  > [Sensitivity adjustment history] screen.



	Name	Description
(1)	Date/time	Displays the date and time when sensitivity adjustment was performed.
(2)	User name	Displays the logged in user when the operation was detected.
(3)	Item	Displays the results detected by sensitivity adjustment.
(4)	[Back] button	Returns to the previous screen.
(5)	USB output	Outputs the history to the USB flash drive as a CSV file.

- The history function saves data only in English.
- Up to the latest 100 history records are displayed.
- Up to the latest 1000 history records are stored and can be output to the USB flash drive as a CSV file.
- If the history exceeds 1000 records, the oldest record is deleted and the latest record is added.

13.32. Impact shock detection history

Display settings: [MENU] key  > [Information] button  > [History] button  > [Impact shock detection history] button  > [Impact shock detection history] screen.

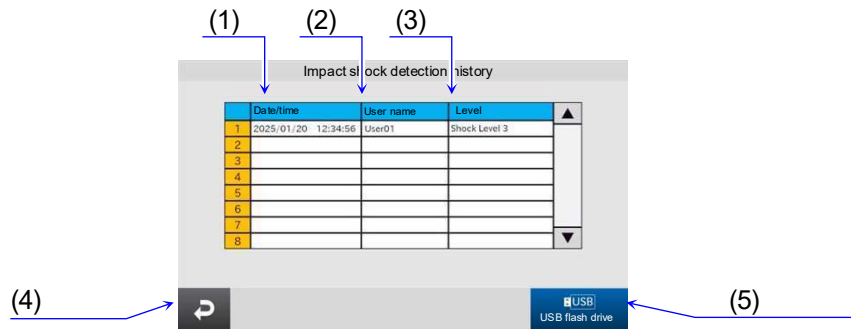

	Name	Description
(1)	Date/time	Displays the date and time when the impact was detected.
(2)	User name	Displays the user who was logged in at the time of impact detection.
(3)	Level	Displays the impact detection level.
(4)	[Back] button	Returns to the previous screen.
(5)	USB output	Outputs the history to the USB flash drive as a CSV file.

- The history function saves data only in English.
- Impacts of impact level 3 or higher are stored on the balance with date and time.
- Impact data when the balance is not energized (during transportation, etc.) is not stored.
- Up to the latest 100 history records are displayed.
- Up to the latest 1000 history records are stored and can be output to the USB flash drive as a CSV file.
- If the history exceeds 1000 records, the oldest record is deleted and the latest record is added.

14. Underhook Weighing

The built-in underhook is used for underhook weighing such as measurement of magnetic materials and the like.

To use the underhook, open the cover on the bottom of the balance.

Removing the underhook cover

Step	Description
1	Move the arm (4) to the front side of the balance.
2	Remove the underhook cover (3) and attach it to the cover holder (5) on the bottom of the balance.
3	Suspend the underhook (2).

CAUTION

- ❑ Do not apply excessive force to the underhook part.
- ❑ Do not open the cover unless necessary. (For protection from dust)
- ❑ The underhook can be used only in the hanging direction (pulling direction).
- ❑ If the balance is tilted greatly, attached parts such as the weighing pan will come off. Remove them before work.
- ❑ Keep in mind that draft enters the balance easily when the underhook cover is removed, affecting the weighing values.
- ❑ When attaching the underhook, unplug the AC adapter from the balance before proceeding.
- ❑ If the IR sensor is set to control the door, disable the IR setting or assign another function to prevent the suspended plate from being caught. For details, refer to "4.1. IR sensors".

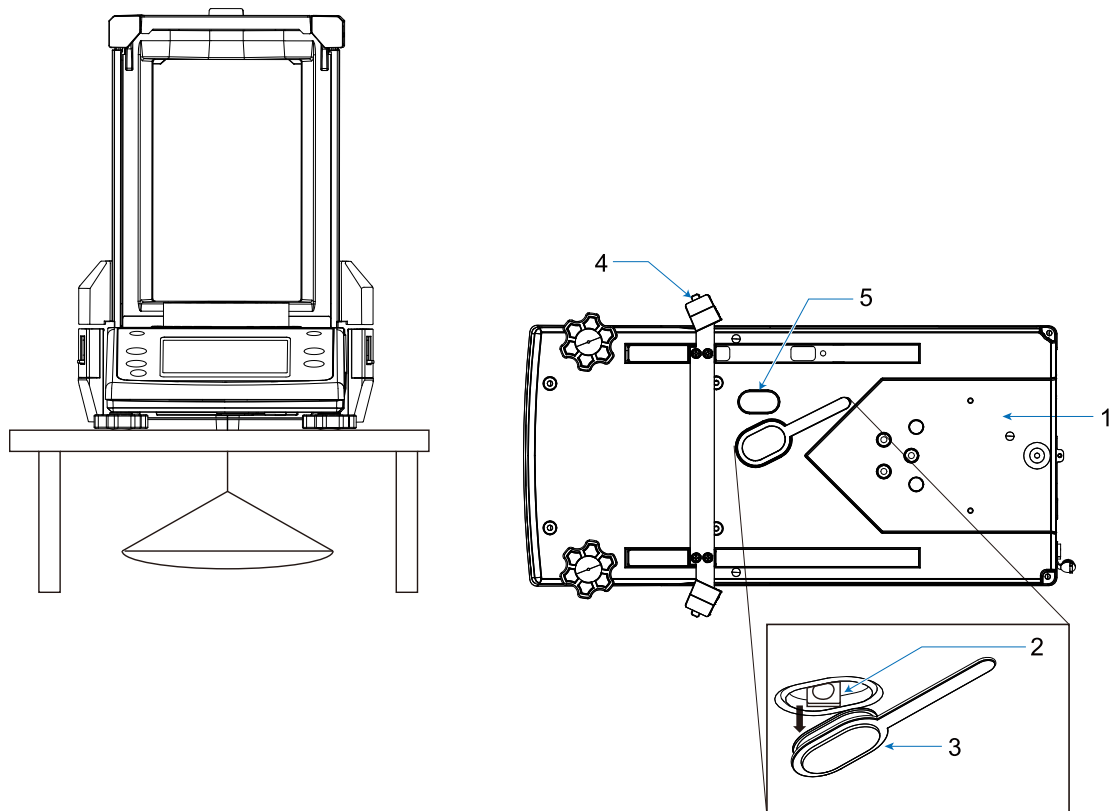

- 1 Bottom of the balance
- 2 Underhook (Hole diameter: approx. 4 mm)
- 3 Cover
- 4 Arm
- 5 Cover holder

15. Interface Specifications (Standard)

15.1. RS-232C specifications

Connector	D-Sub 9-pin (male)	
Transmission system	EIA RS-232C	
Transmission form	Asynchronous, bi-directional	
Transmission rate	5 times/second, 10 times/second (approx.)	
Signal format	Baud rate	600, 1200, 2400, 4800, 9600, 19200, 38400 bps
	Data bits	7 bits or 8 bits
	Parity	EVEN or ODD (at a data bit length of 7 bits) NONE (at a data bit length of 8 bits)
	Stop bits	1 bit
	Code	ASCII

1 character format

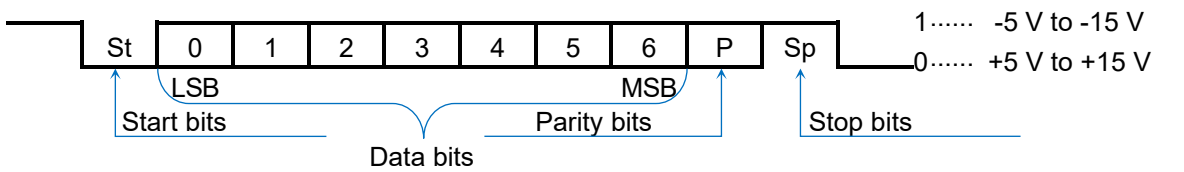

D-Sub 9-pin assignments

Pin No.	Signal name	Direction	Description
1	-	-	Same potential as SG*1
2	TXD	Output	Transmit data
3	RXD	Input	Receive data
4	-	-	N.C.
5	SG	-	Signal ground
6	DSR	Output	Data set ready
7	RTS	Input	Request to send
8	CTS	Output	Clear to send
9	-	Output	12 V output*1

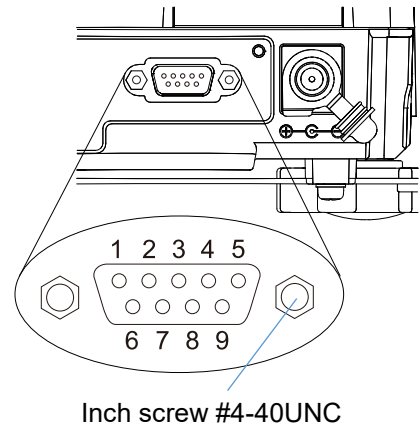

*1 Used with some A&D peripherals. When connecting to third-party devices that have power output, do not connect the wires. Make sure a compatible cable is used, as using the wrong connection cable may damage the device.

Signal names other than TXD and RXD are designated on the DTE side.

Wiring diagram
(when connected to a PC)

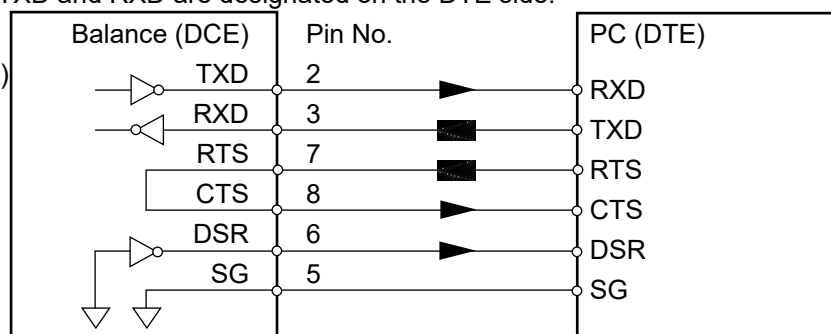

❑ For configuration details, refer to "13.16. RS-232C interface".



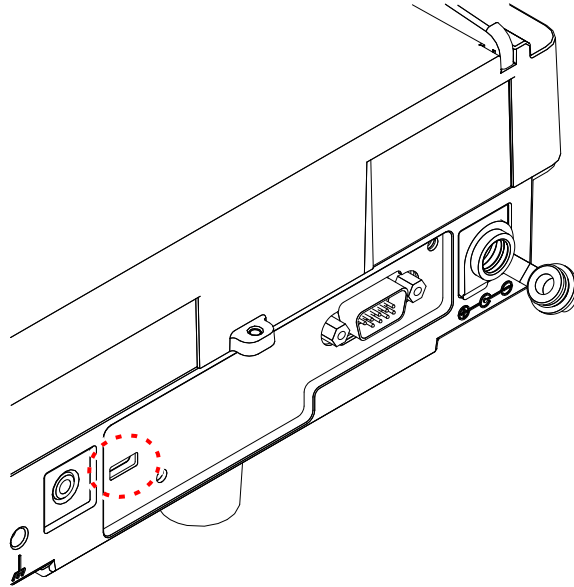

Display settings: [MENU] key > [System Settings] button > [Communication] button > [RS-232C interface] button > In the [RS-232C interface] screen, select [Baud rate], [Data bit, parity bit], [Data format].

15.2. USB specifications

Connector	Type-C
Standards	USB 2.0
Device class	Human Interface Device (HID): Quick USB Communication Device Class (CDC): Virtual COM



CAUTION

- ❑ Power cannot be supplied from a USB AC adapter or mobile battery.
Do not connect a USB AC adapter or mobile battery, as it may cause malfunction.
- ❑ USB Type-C USB flash drives cannot be used.
- ❑ Power cannot be supplied from the balance to external devices.
- ❑ For configuration details, refer to "[13.17. USB interface](#)".
Display settings: [MENU] key  > [System Settings] button  > [Communication] button  > [USB interface] button  > In the [USB interface] screen, select [USB device mode], [Data format].

15.3. USB flash drive (USB host)

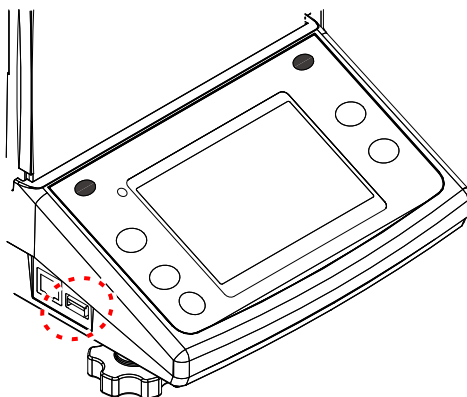

- ❑ In the BH-T series, you can connect a USB flash drive to the USB type A connector. You can save weighing data, etc. in the USB flash drive and import the data into Windows or macOS computers easily. (No driver is required)
- ❑ The balance weighing data, etc. are saved on the USB flash drive in the CSV format. You can save the results of check functions as a PDF file. Change the USB data format as required.
- ❑ A file called "BH-T*****.csv" is generated under the root directory of the USB flash drive and the weighing data is saved there, when the weighing data is output with a [PRINT] button, etc. Copy this file to your computer for managing data, etc.
- ❑ As long as the [HOME] screen (weighing screen) is shown, the new data is appended to the next line of the old data. (A new file is not generated.)
- ❑ Once other screen is shown, a new file is generated and the data is added.



CAUTION

- ❑ Do not connect anything other than a USB flash drive to the USB A type connector.
- ❑ When you want to remove the USB flash drive from the balance, be sure to press the button for removing the USB flash drive before doing so. Otherwise, data may not be written.
- ❑ To prevent unexpected data loss, use the USB flash drive dedicated for this balance and do not use it with other devices.
- ❑ If other data is saved, data may be damaged. No compensation should be paid for loss of data. Be sure to format the USB flash drive on your PC before using the balance.
- ❑ You cannot use USB flash drives with security functions such as antivirus software.
- ❑ You cannot use USB flash drives formatted as NTFS or exFAT. Use USB flash drives formatted as FAT (FAT 16) or FAT 32.
- ❑ Some USB flash drives may not work correctly even if they satisfy the above conditions. Not all USB flash drives are guaranteed to work.
- ❑ You cannot use USB hubs.
- ❑ If the balance does not work after you connecting or removing a USB flash drive that does not satisfy the specified conditions, disconnect the AC adapter of the balance and turn on the power again.

15.4. External input terminal (external input switch)

- ❑ The external input terminal provides the function of the "[RE-ZERO] key input" or "[PRINT] key input" on the balance or "Opening and closing the breeze break door(s)" to the "contact input" via the wire extended from the connected plug.
- ❑ To turn the "contact input" on, short it for 100 ms or more.
- ❑ To use the external input terminal, you must select the function in the [External input switch] screen. Refer to "13.23. External input switch".

Settings in the red box RE-ZERO/PRINT are default values (factory settings).

Display settings: [MENU] key  > [System Settings] button  > [External input switch] button  > [External input switch] screen.

Name	Setting value (setting range)
External input switch	RE-ZERO/PRINT , Breeze break door(s)

- ❑ One external input terminal is on the rear of the main unit.
- ❑ The following optional accessories are available.
AX-SW137-PRINT (sold separately): Foot switch for the [PRINT] key.
AX-SW137-REZERO (sold separately): Foot switch for the [RE-ZERO] key.
- ❑ For the plug connected to the external input terminal, a $\phi 3.5$ mm stereo plug MP-013LC (Marushin Electric Mfg. Co., Ltd) or an equivalent product can be used.

CAUTION

- ❑ Plugs are not included. If you choose to prepare the plug yourself, you will need to solder the plug, wire, switch, and other components.

Circuit diagram of external input terminal

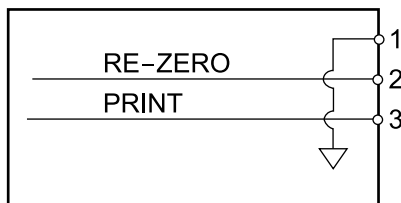

External input terminal

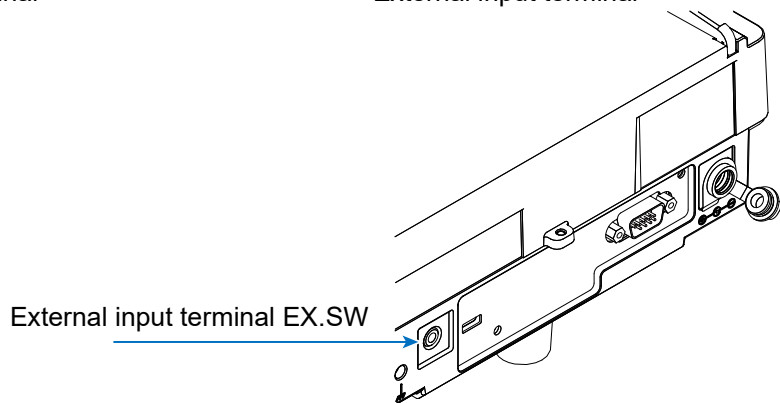

Example of compatible plug

Pin assignment

Pin	Description
1	GND: Common ground terminal
2	RE-ZERO: External contact input
3	PRINT: External contact input

Circuit diagram

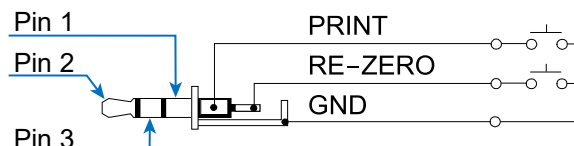

External view

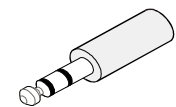



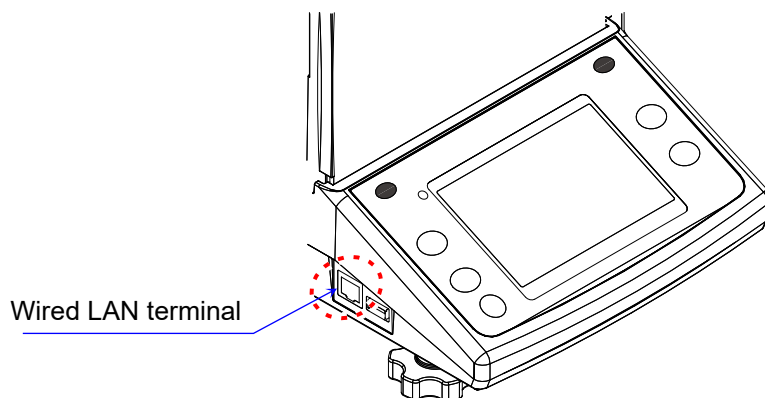

15.5. Wired LAN specifications

Connector: RJ45

Protocol: TCP/IP



- ❑ To use the wired LAN terminal, you must select the setting value in the [Wired LAN] screen. Refer to "13.18. Wired LAN port". Settings in the red box are default values (factory settings).

Display settings: [MENU] key  > [System Settings] button  > [Communication] button  > [Wired LAN] button  > [Wired LAN] screen.

Name	Setting value (setting range)
IP address	For setting values, contact your LAN administrator.
Subnet mask	
Default gateway	
Data format	<input type="text" value="A&D standard format"/> , DP format, KF format, MT format, NU format, NU2 format, CSV format, TAB format, UFC format

- ❑ For details on the data format, refer to "19.2. Weighing data format".

Cautions on the wired LAN

- ❑ For information about the connection to your local area network (LAN), contact your system administrator.
- ❑ To connect to a PC directly, use a cross cable.
To connect via a hub, use a straight cable.
- ❑ Data can be collected by using Windows data communication software "WinCT-Plus".
For details on "WinCT-Plus", refer to "18.6.2. WinCT-Plus (wired LAN)".

15.5.1. Network settings

To make the LAN connection, the settings of the IP address and subnet mask for a computer and the BH-T series need to be set. For the IP address allocation, ask your network administrator.

The factory settings for the BH-T series are as follows. The port number is fixed.

IP address	Subnet mask	Default gateway	Port number
192.168.0. 1	255.255. 255. 0	0.0.0.0	10001

CAUTION

- ❑ Make sure to confirm with your network administrator before connecting to the existing network, as the BH-T series might cause a network trouble. Please note that A&D shall not be liable for any problems that occurs with your network.

Setting of the IP address for computer

Set the IP address and subnet mask of your computer as follows.

Open the TCP/IP properties screen to select 'Use the following IP address'. Enter the IP address and subnet mask.

For the setting values, ask your network administrator.

Example) When directly connecting a computer to a BH-T series balance.

Use a crossing cable for LAN.

	IP address	Subnet mask
Computer	192.168.0. 12	255.255. 255. 0
BH-324TE	192.168.0. 1	255.255. 255. 0

Note: The sequence to open the TCP/IP properties screen

For Windows10:

'Control Panel' > 'Network and Internet' > 'Network and Sharing Center' > 'Ethernet'
> 'Ethernet Properties' > 'Internet Protocol Version 4 (TCP/IPv4) Properties'

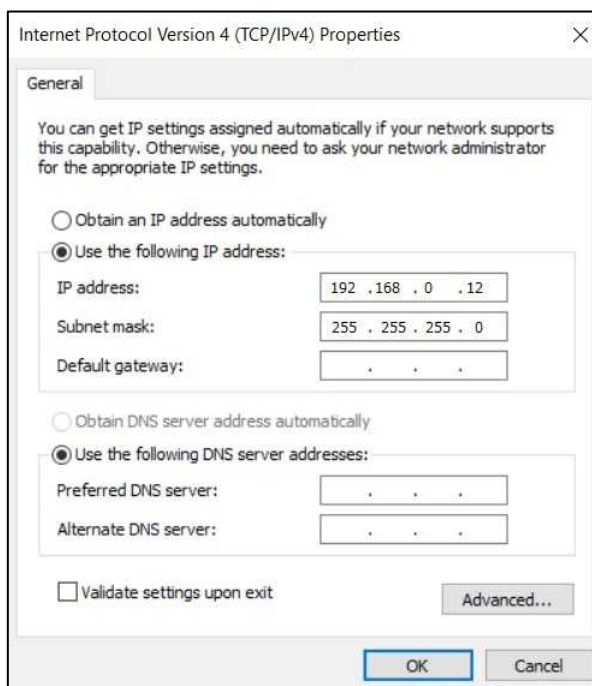

16. Connection with Peripheral Devices

BH-T series analytical balances are equipped with an RS-232C connector and a USB Type C connector, allowing connection to peripherals, PCs, PLCs, and other devices.

16.1. Cables required to connect to peripheral devices

The connection cables that match the interface used with the peripheral device are as follows.

Peripheral and connection cable compatibility table





Peripherals		Communication interface to use	Connection cable		Note
Product name	Model		Standard or sold separately	Cable model	
Multi-functional compact printer	AD-8127	RS-232C	Standard accessory: RS-232C cable included with the printer	AX-KO1710-200	*1
Thermal printer	AD-8129TH			AX-KO2741-100	
Remote display	AD-8920A		Standard accessory: RS-232C cable included with the remote display/controller	AX-KO3412-100	*2 *6
Remote controller	AD-8922A			AX-KO2466-200	
Expansion controller for production line weighing system	AD-8923-BCD		Sold separately	AX-KO-2466	
	AD-8923-CC				
PLC			Sold separately		*3 *4
PC		USB	Standard accessory: USB cable included with the balance	AX-KO7919-200	
		Wired LAN port	Sold separately LAN cable		

Note

- *1 When using the AD-8529PR-W (Bluetooth converter, sold separately), the RS-232C cable that comes with the printer is not used.
- *2 5 m and 10 m cables are also available (sold separately).
- *3 Check the interface specifications of the BH-T series and PLC, and prepare a compatible cable.
- *4 Can be connected to a PC using AX-USB-9P, AD-8541-SCALE, AD-1688, or AD-8527. The connection cable included with these products can be used when transferring data.
- *5 To connect to a PC directly, use a cross cable. To connect via a hub, use a straight cable.
- *6 Some functions, such as the [SAMPLE] button and [MODE] button, cannot be used.

16.2. Data output method

The operation of the balance can be changed by setting the function table to the settings suitable for the intended use. For details on the function table, refer to "13.7. Data output".

Display settings: [MENU] key  > [System Settings] button  > [Communication] button  > [Data output] button  > [Data output] screen.

- The output method of weighing data via the RS-232C/USB interface can be specified in the [Data output mode] screen of the function table ("13.7. Data output").





Display settings: [MENU] key  > [System Settings] button  > [Communication] button  > [Data output] button  > [Data output mode] button  > [Data output mode] screen.

Table of the data output mode

Item	Setting value	Description
Data output mode	Key mode	<ol style="list-style-type: none"> 1. Outputs with the [PRINT] button if the weighing value is stable. 2. Immediately outputs with the [PRINT] button regardless of whether or not the weighing value is stable. 3. Immediately outputs with the [PRINT] button if the weighing value is stable. If the weighing value is not stable, outputs once it has stabilized.
	Auto print mode	<ol style="list-style-type: none"> 1. Automatically outputs data when stable (Reference = zero) 2. Automatically outputs data when stable (Reference = Last stable value)
	Stream mode	Outputs continually
	Interval mode	Starts outputting with the [PRINT] button at the specified period.

Settings in the red box are default values (factory settings).

16.3. Examples: Connecting multiple peripheral devices

16.3.1. Printer and PC connection

Table of settings by connection method

Connection method		Function table for the connection interface/connected device	
Interface	Device	Class	Description
(Common settings)			Selects the data output mode suitable for the intended use and settings of the printer/PC*1
RS-232C	Printer	Serial interface	Selects the data output format suitable for the settings of the printer and applications. (A&D standard format, DP format)
USB	PC	USB interface	Selects an output format that allows the PC to process easily (The data format is fixed to NU2 format when using Quick USB mode.)
Wired LAN port		Wired LAN port	

*1 The data output mode is an item common to the printer and PC. The weighing value is output at the same timing.

Connecting the printer to the balance

- The dedicated printers for balances are: AD-8127 (multi-functional printer) and AD-8129TH (thermal printer).
Connect the printer and the balance with an RS-232C cable.

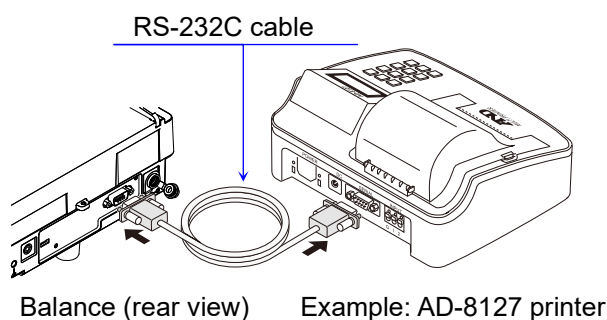

Connecting the PC to the balance

- To connect the balance and the PC only, you can connect with the USB cable, LAN cable or RS-232C cable.
- If the PC does not have an RS-232C interface (COM port), you can use a USB converter (AX-USB-9P).

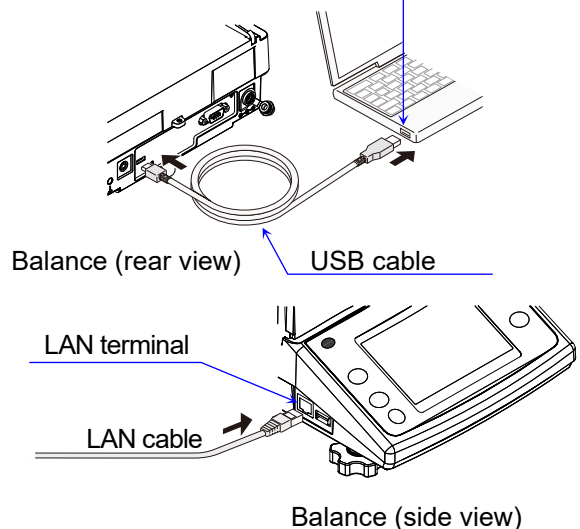
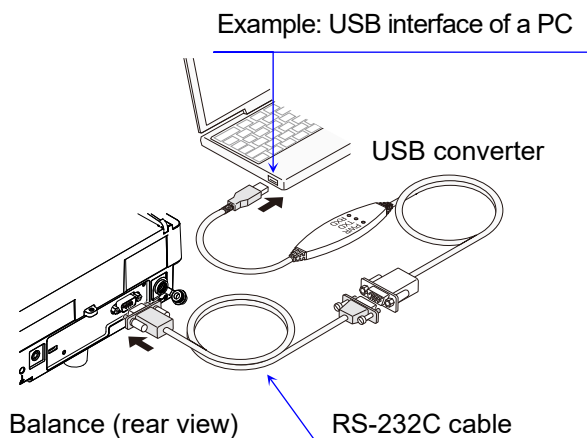
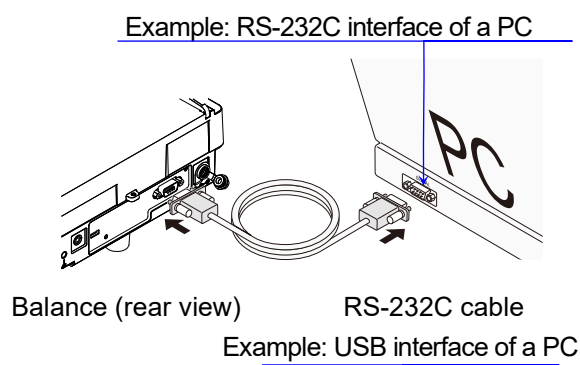

16.3.2. Printer and remote display connection

Example of use Displaying the weighing value on a remote display while printing the weighing value on a printer.

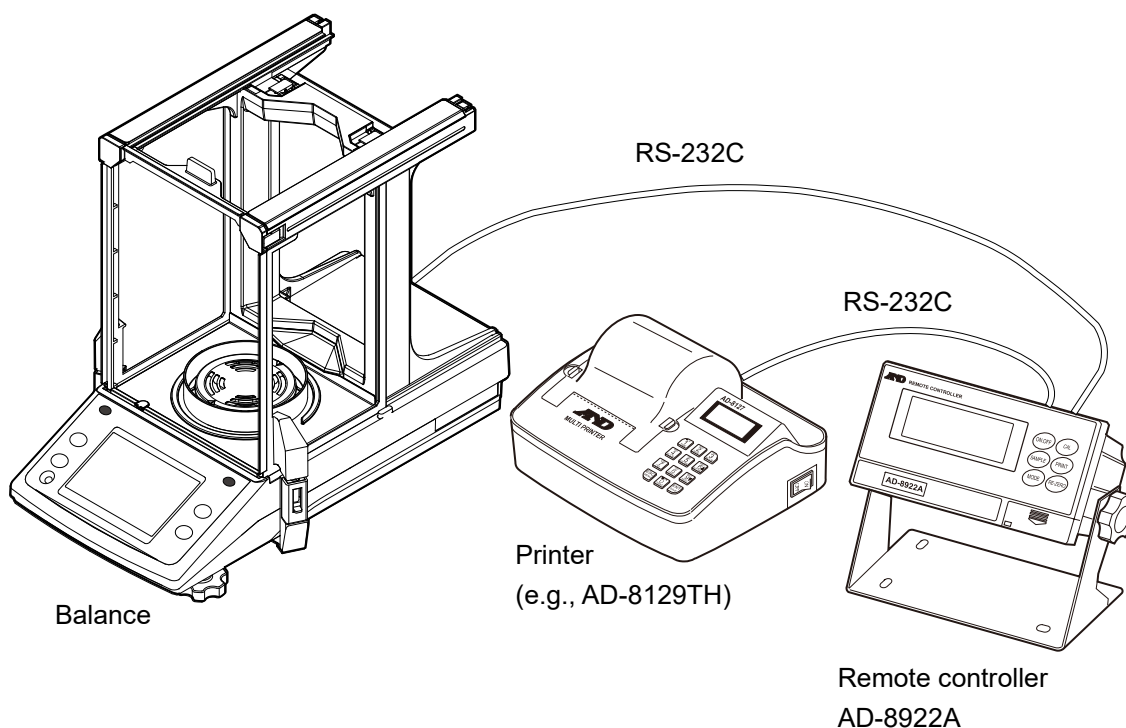

Balance and AD-8922A remote controller

Connection method		Connection interface	
Interface	Device	Class	Description
RS-232C	AD-8922A	Serial interface	Stream mode

AD-8922A remote controller and printer

Connection method		Connection interface			
Interface	Device	AD-8922A function table	Item	Parameter	Description
AD-8922A (RS-232C)	Printer	<input type="text" value="Fnc"/>	out	?	Output data with the [PRINT] key on the AD-8922A

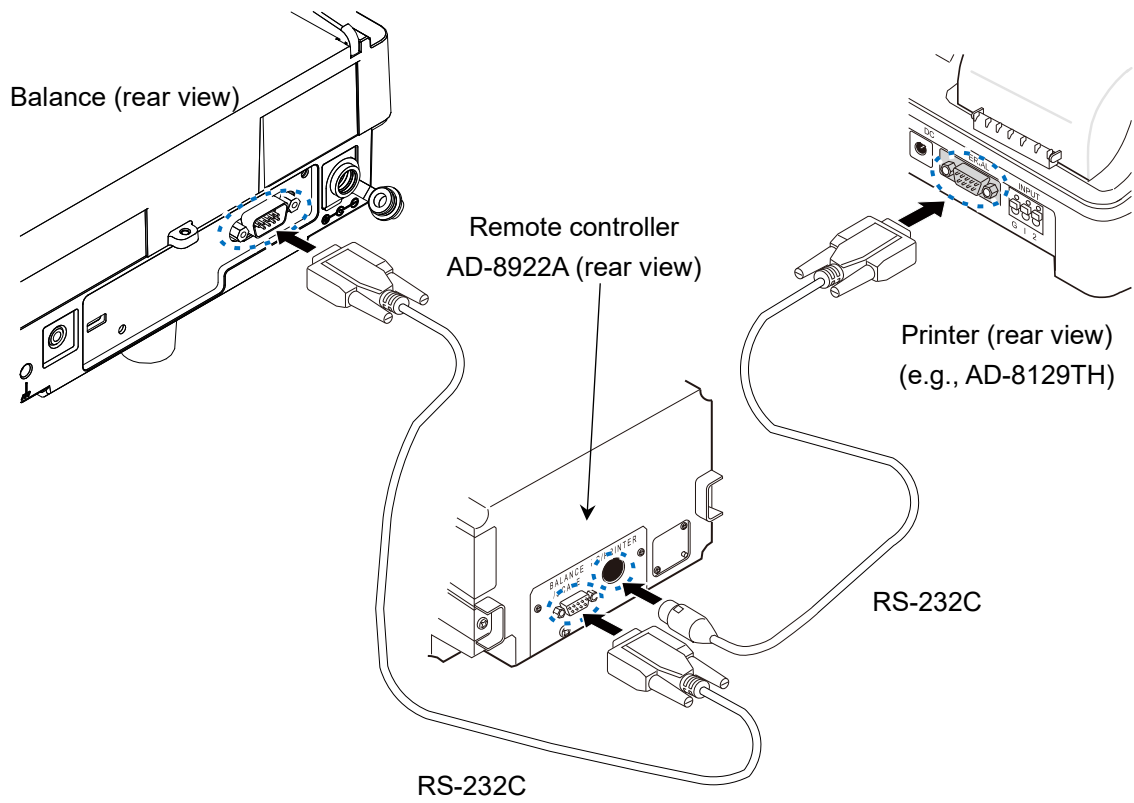

17. Printing Weighing Value Data with a Printer

Refer to the following setting examples for the printer settings and the balance's function table according to the printer to be used and the method of printing weighing data.

17.1. Printer: AD-8127, AD-8129TH

17.1.1. Printing only weighing value data

Common settings with the balance when printing only weighing value data on the AD-8127 or AD-8129TH

Item	Description
Data format	A&D standard format

Settings for printing only weighing value data on the AD-8127 or AD-8129TH

Printing method	Balance function table	AD-8127/AD-8129TH function table	
	Description	PRN .MODE	Description
Prints weighing value data when the [PRINT] button of the balance is pressed.	Key mode: Outputs only when the display is stable	EXT.KEY	External key print mode
	Key mode: Outputs regardless of whether the display is stable or unstable*1		
	Key mode: Outputs when stable		
Automatically prints weighing value data according to the change in the weighing value.	Auto print mode: Reference = zero		
	Auto print: Reference = Last stable value		
Prints weighing value data at regular intervals.	Interval mode*1		
Prints weighing value data when the [PRINT] button of the printer is pressed.	Stream mode*1	MANUAL	Manual print mode
Prints weighing value data in chart format.		CHART	Chart print mode

*1 Unstable data is also output.

To set the AD-8127/AD-8129TH to a mode other than dump print mode and also print unstable data, change the setting to "Unstable data, Printed out ("US PRN", "PRINT")" in the function table of the AD-8127/AD-8129TH.

❑ For details on the A&D standard format, refer to "19.2. Weighing data format".

You can select the A&D standard format for each connection in the following screen.

[MENU] key  > [System Settings] button  > [Communication] button  > [RS-232C interface] button  > In the [RS-232C interface] screen, select [A&D standard format].

❑ For details about [Key mode], [Auto print mode], [Interval output mode] and [Stream mode], refer to "19.1. Data output mode". Set the data output mode in the following screen.

[MENU] key  > [System Settings] button  > [Communication] button  > [Data output] button  > [Data output mode] button  > In the [Data output mode] screen, select the mode.

17.1.2. Printing weighing data with ID and timestamp using the balance's clock/calendar function

Common settings with the balance when printing weighing value data and other information on the AD-8127 or AD-8129

Item	Description
Data format	DP format

Settings for printing weighing value data and other information on the AD-8127 or AD-8129TH

Printing method	Balance function table	Function table of AD-8127, AD-8129TH	
	Description	PRN .MODE	Description
Prints weighing value data when the [PRINT] button of the balance is pressed.	Key mode: Outputs only when the display is stable	DUMP	Dump print mode
	Key mode: Outputs regardless of whether the display is stable or unstable*1		
	Key mode: Outputs when stable		
Automatically prints weighing value data according to the change in the weighing value.	Auto print mode: Reference = zero		
	Auto print: Reference = Last stable value		
Prints weighing value data at regular intervals.	Interval mode*1		

*1 Unstable data is also output.

To set the AD-8127/AD-8129TH to a mode other than dump print mode and also print unstable data, change the setting to "Unstable data, Printed out ("US PRN", "PRINT")" in the function table of the AD-8127/AD-8129TH.

- You cannot print with printer keys or in chart format.
- For details on the DP format, refer to "19.2. Weighing data format".

You can select the DP format for each connection in the following screen.

[MENU] key  > [System Settings] button  > [Communication] button  > [RS-232C interface] button  > In the [RS-232C interface] screen, select [DP format].

- For details about [Key mode], [Auto print mode], [Interval output mode] and [Stream mode], refer to "19.1. Data output mode". Set the data output mode in the following screen.

[MENU] key  > [System Settings] button  > [Communication] button  > [Data output] button  > [Data output mode] button  > In the [Data output mode] screen, select the mode.

17.1.3. Printing information other than weighing value data

To print sensitivity adjustment/calibration test reports (GLP compliant output) or to perform output of the statistical calculation result calculated by the balance, change the setting of the printer to the dump print mode.

Printer function table for printing information other than weighing value data on the AD-8127 or AD-8129TH

PRN .MODE	Description
DUMP	Dump print mode

❑ Switching the AD-8127/AD-8129TH print mode (PRN MODE)

By pressing and holding the [ENT] key of the AD-8127/AD-8129TH, it is possible to switch between EXT.KEY (External key print mode) and DUMP (Dump print mode) without using the function table of the printer.

This is convenient when temporarily switching the AD-8127/AD-8129TH to dump print mode for GLP output, etc.

❑ The GLP/GMP compliant data can be output to a PC or optional printer.

Set the GLP/GMP settings in the following screen.

[MENU] key  > [System Settings] button  > [Communication] button  > [GLP output] button  > Set in the [GLP output] screen.

18. Connecting to a PC

18.1. Quick USB mode





- ❑ The quick USB mode is a function where a balance connected to a PC with a USB cable and inputs the output of the balance directly to the software on the personal computer, such as Excel or Word. The supported OS is Windows 7 or later.

Since the Windows standard driver (HID) is used, there is no need to install a dedicated driver and communication is possible simply by connecting.

CAUTION

- ❑ Quick USB is a one-way communication from the balance to the PC. It is not possible to send commands to control the balance from the PC.
- ❑ Turn off the screen saver and standby mode of the PC.
- ❑ Do not use Quick USB when the data output mode of the balance is set to the stream mode.
- ❑ In stream mode, the balance keeps outputting weighing data to the PC. It may cause unintended operation on the computer.

Setting procedure

- ❑ To use the Quick USB mode, set the function table of the balance to [Quick USB mode].
[MENU] key  > [System Settings] button  > [Communication] button  > [USB interface] button  > Select in the [USB interface] screen.

USB output format

- ❑ The data format is fixed to NU2 format when USB is used.
- ❑ For details on the output format, refer to "[19.2. Weighing data format](#)" (function table).

Setting procedure (to send weighing data with the [PRINT] button of the balance)

Step	Description
1	In the function table of the balance, set to [Quick USB].
2	Connect the balance to the PC with the included USB cable.
3	When the PC is connected to the balance for the first time, the computer will automatically start installing the driver.
4	Start the software (Excel, etc.) used for weighing data transmission on the computer.
5	Be sure to set the keyboard to single-byte input mode. (Data cannot be entered correctly in the double-byte input mode.)
6	Place the cursor where you want to enter the weighing data.
7	Press the [PRINT] button  of the balance to send weighing data from the balance and enter it at the cursor position.
8	To finish data transmission, disconnect the USB cable.





18.2. Virtual COM mode

- ❑ Virtual COM mode is a function where a balance connected to a PC with the included USB cable, creates a COM port on the PC and performs bidirectional communication.
- ❑ The supported OS is Windows 7 or later. When using this mode for the first time on a PC running an operating system other than Windows 10 or Windows 11, it is necessary to install the dedicated driver on the PC.
- ❑ For detailed instructions on how to install the driver, refer to the PDF file in the [driver for Virtual COM mode*1](#) on the A&D website (<https://www.aandd.jp>).
*1 User information must be entered in order to download the driver.
- ❑ Communication equivalent to RS-232C is possible by selecting the COM port with WinCT (Windows Communication Tools Software).
In Virtual COM mode, it is not necessary to set the baud rate, data bit, parity, or stop bit of the data communication software.

CAUTION

- ❑ When installing the driver for Virtual COM mode for the first time, it may take some time to install.

Setting procedure

- ❑ To use the Virtual COM mode, set [Virtual Com mode] in the function table of the balance.
[MENU] key  > [System Settings] button  > [Communication] button  > [USB interface] button  > Select in the [USB interface] screen.

18.3. RS-232C

- ❑ The RS-232C interface of the balance is data communication equipment (DCE) that can be connected to a PC.
Use a straight-type RS-232C cable for the connection.
If the computer does not have an RS-232C connector, connect it using USB Virtual COM mode.

18.4. LAN

Refer to "[15.5. Wired LAN specifications](#)".

18.5. Bluetooth

Refer to "[13.19. Bluetooth](#)".

18.6. Data communication software

18.6.1. WinCT (USB virtual COM mode or RS-232C)

- WinCT is Windows-based data communication software designed for easily receiving weighing data from the balance on your PC. The PC communication settings use either Virtual COM mode via USB connection or RS-232C.
- WinCT can be downloaded from the A&D website (<https://www.aandd.jp>). For installation and setup instructions, refer to the relevant manuals available on the A&D website.
- WinCT includes three applications: "RsCom", "RsKey", and "RsWeight".

RsCom

- Allows you to control the balance by sending commands to the balance.
- Displays received data and saves it as a text file (.txt).
- Enables communication with multiple balances by running multiple instances.
- Can be run simultaneously with other applications. (Does not monopolize the PC.)
- Receives GLP output data from the balance.

RsKey

- Directly inputs weighing data from the balance into other applications.
- Compatible with any application that allows keyboard input, such as Word or Excel.
- Inputs GLP output from the balance.
- Uses the test display function to make the PC an external display for the balance (in stream mode).

RsWeight

- Graphs received data in real-time.
- Calculates and displays maximum, minimum, average, standard deviation, and coefficient of variation of received data.
- Displays received data and saves it as a CSV file.
- Allows re-graphing by opening a CSV file.

18.6.2. WinCT-Plus (wired LAN)

- WinCT-Plus is Windows-based data communication software designed for easily receiving weighing data from the balance on your PC. The PC communication settings use a wired LAN connection, Virtual COM mode via USB connection, or RS-232C.
- Download "WinCT-Plus" from the A&D website (<https://www.aandd.jp>). For installation and setup instructions, refer to the "WinCT-Plus" items available on the A&D website.
- "WinCT-Plus" includes the application "RsMulti".

RsMulti

- Manages data sent to a single PC from multiple weighing devices connected via Ethernet (LAN).
- Up to 100 weighing devices can be connected. However, this may be limited by the PC's performance and the frequency of data acquisition.
- Pressing the [PRINT] button on the weighing device will send data to the PC.

19. Data Output

19.1. Data output mode

- ❑ The timing of data output of the balance can be changed by using the [Data output mode] screen in the function table ("[13.7. Data output](#)").
- ❑ You can configure the [Key mode], [Auto print mode], [Interval output mode] and [Stream mode] settings in the following screen.

[MENU] key  > [System Settings] button  > [Communication] button  > [Data output] button  > [Data output mode] button  > [Data output mode] screen.

19.1.1. Key mode

Output only when the display is stable

- ❑ If the [PRINT] button  is pressed when the stabilization indicator is displayed, the weighing value will be output once.
At this time, the weighing value display will blink once to show that it has been output.

Output regardless of whether the display is stable or unstable

- ❑ Regardless of whether the stabilization indicator is turned on or not, the weighing value will be output when the [PRINT] button  is pressed.

Output after the display becomes stable

- ❑ If the [PRINT] button  is pressed when the stabilization indicator is displayed, the weighing value will be output once.
If the stabilization indicator is not displayed, the weighing value will be output once the next time the stabilization indicator is turned on.
At this time, the weighing value display will blink once to show that it has been output.

19.1.2. Auto print mode

Zero point

- ❑ If the weighing value exceeds the range from the "zero display" specified with [Bandwidth], [Standard] or [Polarity] in the [Data output mode] screen in the function table and the stabilization indicator is displayed, the weighing value will be output once ("[13.7. Data output](#)"). In addition, if the [PRINT] button  is pressed when the stabilization indicator is displayed, the weighing value will be output once.
At this time, the weighing value display will blink once to show that it has been output.

Last stable value

- ❑ If the weighing value does not fall below the range from the "latest value with the stabilization indicator displayed" specified with [Bandwidth], [Standard] or [Polarity] in the [Data output mode] screen in the function table and the stabilization indicator is displayed, the weighing value will be output once ("[13.7. Data output](#)"). In addition, if the [PRINT] button  is pressed when the stabilization indicator is displayed, the weighing value will be output once. At this time, the weighing value display will blink once to show that it has been output.



19.1.3. Stream mode

- ❑ Regardless of whether the stabilization indicator is on or not, the weighing value will be output at the display refresh rate.

CAUTION

- ❑ Depending on the display refresh rate and baud rate, all data may not be transmitted unless the baud rate is increased.

19.1.4. Interval mode

- ❑ Regardless of whether the stabilization indicator is turned on or not, the weighing value will be output at the interval specified for [Interval time] in the [Data output mode] screen of the function table ("[13.7. Data output](#)"). Press the [PRINT] button to start output, and press the [PRINT] button  again during output to stop it. 
- ❑ In the Interval output mode, [START] and [STOP] are added to the [PRINT] button  in the [HOME] screen.

CAUTION

- ❑ Depending on the combination of "Interval time" and "Baud rate", all data may not be transmitted unless the baud rate is increased.

19.2. Weighing data format

Selecting weighing data format

- ❑ You can select the output format for the RS-232C connection in the [RS-232C interface] screen.
For configuration details, refer to "[13.16. RS-232C interface](#)".

[MENU] key  > [System Settings] button  > [Communication] button  > [RS-232C interface] button  > In the [RS-232C interface] screen, select the output format.



- ❑ You can select the output format for the USB connection in the [USB interface] screen.
For configuration details, refer to "[13.17. USB interface](#)".

[MENU] key  > [System Settings] button  > [Communication] button  > [USB interface] button  > In the [USB interface] screen, select the output format.

- ❑ You can select the output format for the LAN connection in the [Wired LAN] screen.
For configuration details, refer to "[13.18. Wired LAN port](#)".

[MENU] key  > [System Settings] button  > [Communication] button  > [Wired LAN] button  > In the [Wired LAN] screen, select the output format.

- ❑ You can select the output format for the Bluetooth connection in the [Bluetooth] screen.
For configuration details, refer to "[13.19. Bluetooth](#)".

[MENU] key  > [System Settings] button  > [Communication] button  > [Bluetooth] button  > In the [Bluetooth] screen, select the output format.

A&D standard format

- ❑ This is the standard format for sending data to peripheral devices.
- ❑ Consists of 16 characters (not including the terminator).
- ❑ The condition of the data is indicated with a 2-character header.
- ❑ The data is padded with polarity and zeros (filling the data's higher order's surplus part with zeros).
- ❑ When the data is zero, the polarity is positive.
- ❑ The unit consists of three characters.

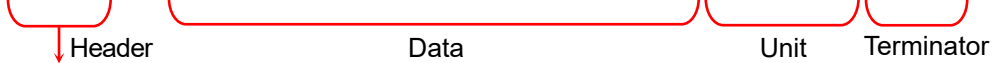
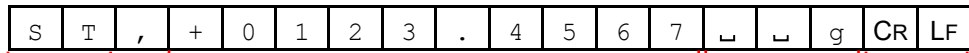

S	T	When stable	CR	CR : Carriage return, ASCII 0Dh
U	S	When unstable	LF	LF : Line feed, ASCII 0Ah
Q	T	Counting mode when stable	␣	␣ : Space, ASCII 20h
O	L	When overloaded		

- ❑ In the external key print mode of the AD-8127 multi-functional compact printer or AD-8129TH compact thermal printer, a received A&D standard format is printed as shown on the right.

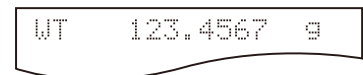

- ❑ If the gross/tare weight is added in the [Data to be added] screen of the function table, the second header corresponding to the output data is appended to the header ("13.9. Data to be added").

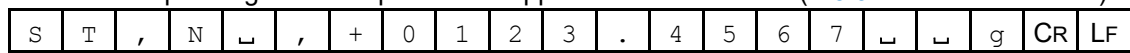

N	␣	Net weight	CR	CR: Carriage return, ASCII 0Dh
G	␣	Gross weight	LF	LF : Line feed, ASCII 0Ah
T	␣	Tare weight	␣	␣ : Space, ASCII 20h
P	T	Preset tare weight		

Display settings: [MENU] key > [System Settings] button > [Communication] button > [Data output] button > [Data to be added] button > [Data to be added] screen.

DP format (dump print)

- ❑ This format is suitable for dump printing.
- ❑ Consists of 16 characters (not including the terminator).
- ❑ The condition of the data is indicated with a 2-character header.
- ❑ The polarity sign is added right before the value if it is not an overload or zero.
- ❑ The data is zero-suppressed (leading zeros are replaced with spaces).
- ❑ The unit consists of three characters.

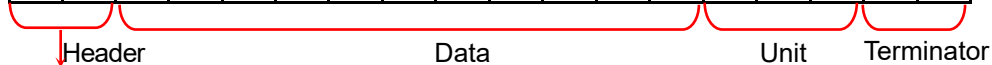
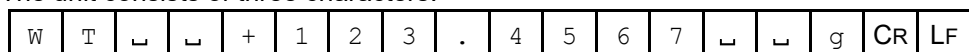

W	T	When stable	CR	CR : Carriage return, ASCII 0Dh
U	S	When unstable	LF	LF : Line feed, ASCII 0Ah
Q	T	Counting mode when stable	␣	␣ : Space, ASCII 20h

KF format

- ❑ This is the Karl-Fischer moisture meter format.
- ❑ Consists of 14 characters (not including the terminator).
- ❑ There are no headers.
- ❑ The polarity sign is added to the first character if it is not an overload or zero.
- ❑ The data is zero-suppressed (leading zeros are replaced with spaces).
- ❑ When stable, the unit is output. When not stable, the unit is not output.

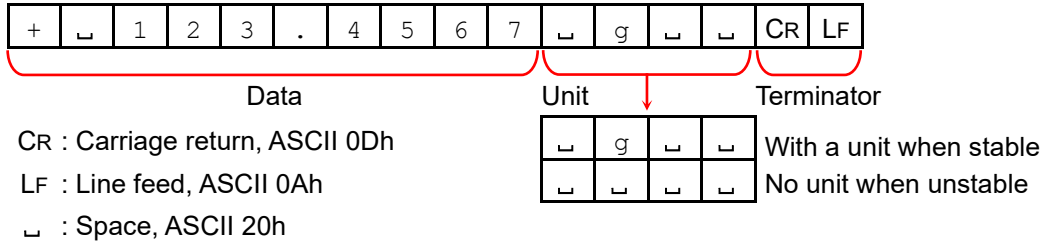

MT format

- ❑ Used when connecting to devices manufactured by other companies. Note that there is no guarantee of compatibility.
- ❑ The length of data depends on the length of the unit.
- ❑ Has a two-character header.
- ❑ The data is zero-suppressed (leading zeros are replaced with spaces).

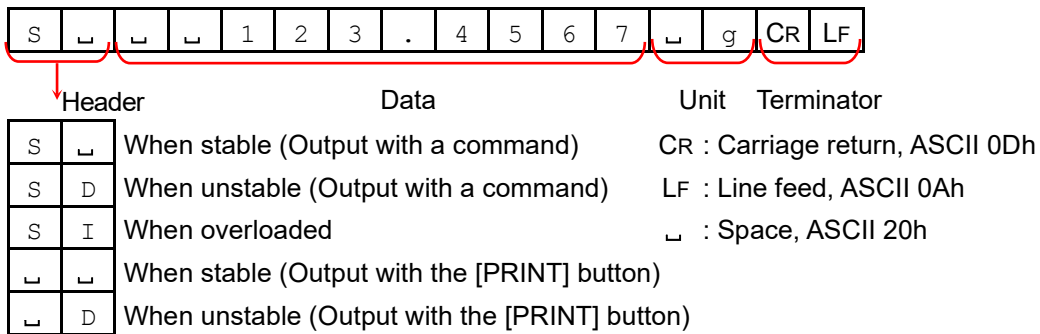

NU format

- ❑ Only numerical data of the weighing value is output.
- ❑ Consists of 10 characters (not including the terminator).
- ❑ The data is padded with polarity and zeros (filling the data's higher order's surplus part with zeros).
- ❑ If the data is zero, the polarity is positive.

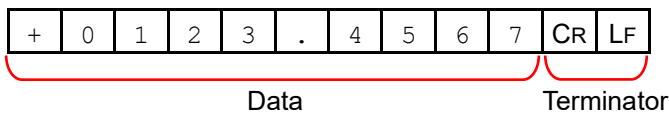

NU2 format

- ❑ Only numerical data of the weighing value is output.
- ❑ If the data is zero or positive, polarity is not added.

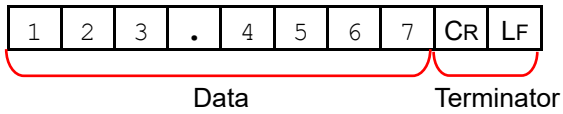

CSV format

- ❑ The data part and unit part of the A&D standard format are separated by a separator ",".
- ❑ Outputs the unit even when overloaded.
- ❑ When the decimal comma (,) is set, a semicolon (;) will be used instead as a separator.

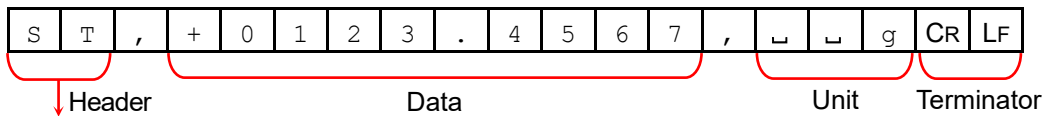

S	T	When stable	CR : Carriage return, ASCII 0Dh
U	S	When unstable	LF : Line feed, ASCII 0Ah
Q	T	Counting mode when stable	␣ : Space, ASCII 20h
O	L	When overloaded	

- ❑ If the gross/tare weight is added in the [Data to be added] screen of the function table, the second header corresponding to the output data is appended to the header ("13.9. Data to be added").

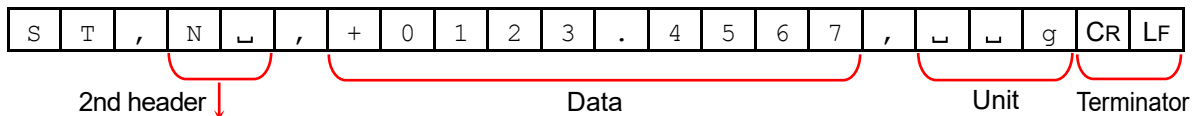

N	␣	Net weight	CR: Carriage return, ASCII 0Dh
G	␣	Gross weight	LF : Line feed, ASCII 0Ah
T	␣	Tare weight	␣ : Space, ASCII 20h
P	T	Preset tare weight	

Display settings: [MENU] key > [System Settings] button > [Communication] button > [Data output] button > [Data to be added] button > [Data to be added] screen.

- ❑ When other data is added to the weighing value, all data will be output in one line. The output sample will be as follows if the ID number, data number, date and time are added.

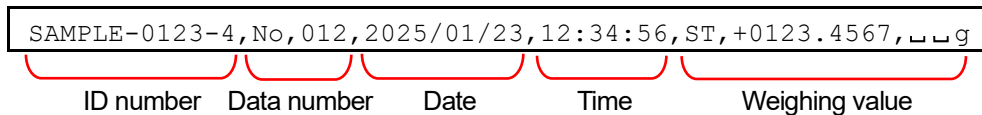

TAB format

- ❑ This is a format, in which the separator of the CSV format is changed from comma to TAB.
- ❑ Used when connecting to a PC and inputting to Excel and the like.

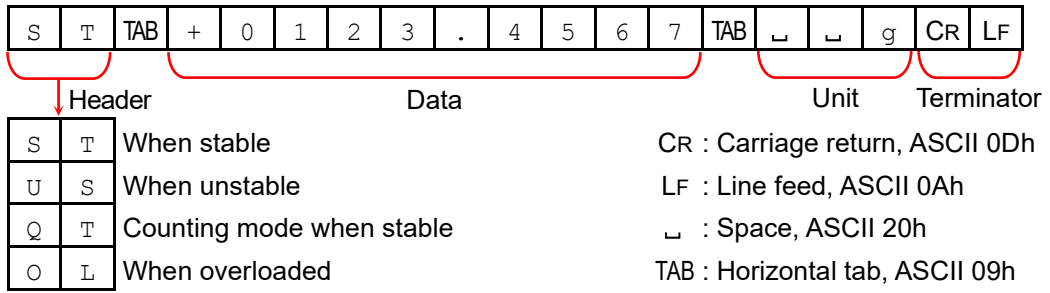

19.2.1. Output examples of weighing data format

When stable

° 123.4567 g

A&D	S	T	,	+	0	1	2	3	.	4	5	6	7	┐	┐	g	CR	LF
DP	W	T	┐	┐	+	1	2	3	.	4	5	6	7	┐	┐	g	CR	LF
KF	+	┐	1	2	3	.	4	5	6	7	┐	g	┐	┐	CR	LF		
MT	S	┐	┐	┐	1	2	3	.	4	5	6	7	┐	g	CR	LF		
NU	+	0	1	2	3	.	4	5	6	7	CR	LF						
NU2	1	2	3	.	4	5	6	7	CR	LF								

When unstable

-1.2345 g

A&D	U	S	,	-	0	0	0	1	.	2	3	4	5	┐	┐	g	CR	LF
DP	U	S	┐	┐	┐	┐	-	1	.	2	3	4	5	┐	┐	g	CR	LF
KF	-	┐	┐	┐	1	.	2	3	4	5	┐	┐	┐	┐	CR	LF		
MT	S	D	┐	┐	┐	-	1	.	2	3	4	5	┐	g	CR	LF		
NU	-	0	0	0	1	.	2	3	4	5	CR	LF						
NU2	-	1	.	2	3	4	5	CR	LF									

When overloaded
(positive)

E

A&D	O	L	,	+	9	9	9	9	9	9	9	E	+	1	9	CR	LF	
DP	┐	┐	┐	┐	┐	┐	┐	┐	E	┐	┐	┐	┐	┐	┐	┐	CR	LF
KF	┐	┐	┐	┐	┐	┐	H	┐	┐	┐	┐	┐	┐	┐	CR	LF		
MT	S	I	+	CR	LF													
NU	+	9	9	9	9	9	9	9	9	9	CR	LF						
NU2	+	9	9	9	9	9	9	9	9	9	CR	LF						

When overloaded
(negative)

-E

A&D	0	L	,	-	9	9	9	9	9	9	9	9	E	+	1	9	CR	LF	
DP	␣	␣	␣	␣	␣	␣	␣	-	E	␣	␣	␣	␣	␣	␣	␣	␣	CR	LF
KF	␣	␣	␣	␣	␣	␣	L	␣	␣	␣	␣	␣	␣	␣	␣	␣	CR	LF	
MT	S	I	-	CR	LF														
NU	-	9	9	9	9	9	9	9	9	9	CR	LF							
NU2	-	9	9	9	9	9	9	9	9	9	CR	LF							

Unit code

	A&D CSV TAB	DP	KF	MT
Gram	▬ ▬ g	▬ ▬ g	▬ g ▬ ▬	▬ g
Milligram	▬ m g	▬ m g	▬ m g ▬	▬ m g
Counting mode	▬ P C	▬ P C	▬ p c s	▬ P C S
Percent mode	▬ ▬ %	▬ ▬ %	▬ % ▬ ▬	▬ %
Ounce (Avoir.)	▬ o z	▬ o z	▬ o z ▬	▬ o z
Troy Ounce	o z t	o z t	▬ o z t	▬ o z t
Metric Carat	▬ c t	▬ c t	▬ c t ▬	▬ c t
Momme	m o m	m o m	▬ m o m	▬ m o
Pennyweight	d w t	d w t	▬ d w t	▬ d w t
Grain	▬ G N	▬ G N	▬ g r ▬	▬ G N
Tael (HK general, Singapore)	▬ t l	▬ t l	▬ t l s	▬ t l
Tael (HK, jewelry)	▬ t l	▬ t l	▬ t l h	▬ t l
Tael (Taiwan)	▬ t l	▬ t l	▬ t l t	▬ t l
Tael (China)	▬ t l	▬ t l	▬ t l c	▬ t l
Tola (India)	▬ ▬ t	▬ ▬ t	▬ t o l	▬ t
Mesghal	m e s	m e s	▬ M S ▬	▬ m

ASCII code symbols

CR : Carriage return, ASCII 0Dh

LF : Line feed, ASCII 0Ah

▬ : Space, ASCII 20h

TAB : Horizontal tab, ASCII 09h

19.2.2. Other data formats

In addition to weighing data, various data can be added.

Change the ON/OFF of each setting in the function table as necessary.

ASCII code symbols

CR: Carriage return, ASCII 0Dh

␣: Space, ASCII 20h

LF: Line feed, ASCII 0Ah

Data number output

- ❑ When the statistical calculation function is used, the data number is output.
- ❑ Consists of 6 characters (not including the terminator).
- ❑ In Quick USB mode, only dots (".") and numbers are output.

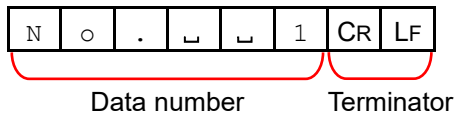

For Quick USB connection:

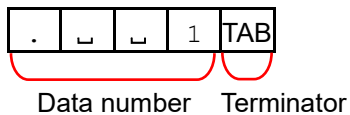

ID number

- ❑ The ID number stored in the balance is output.
- ❑ Consists of 13 characters (not including the terminator).
- ❑ In Quick USB mode, only the hyphen ("-") and numbers are output.

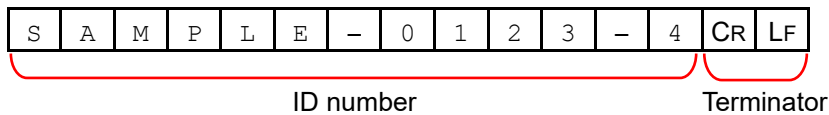

For Quick USB connection:

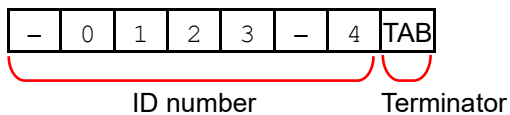

Date

- ❑ Outputs the date from the clock data of the balance.
- ❑ The order of YYYY/MM/DD can be changed in the setting.
- ❑ Consists of 10 characters (not including the terminator).
- ❑ In Quick USB mode, slashes ("/") are converted to dots (".") and output.

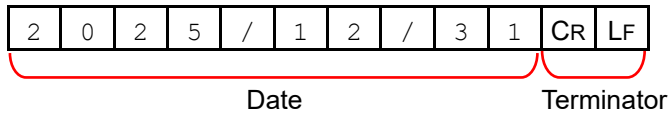

For Quick USB connection:

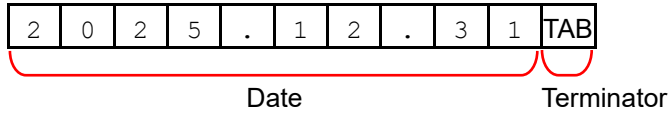

Time

- ❑ Outputs the time from the clock data of the balance.
- ❑ 24-hour format.
- ❑ Consists of 8 characters (not including the terminator).
- ❑ In Quick USB mode, colons (":") are converted to dots (".") and output.

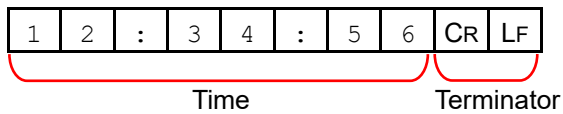

For Quick USB connection:

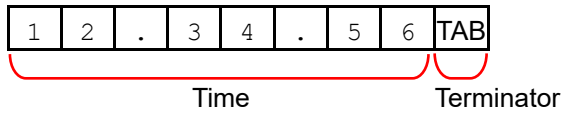

20. Command

By sending the specified commands from a PC or a PLC to the balance, it is possible to control the balance to perform "weighing data request", "key operations", "setting value change", etc. To send a command to the balance, add a terminator (CR LF or CR) to the command character string. You can set the terminator in the [Command settings] screen described in "13.11. Command settings".

ASCII code symbols

CR	: Carriage return, ASCII 0Dh	LF	: Line feed, ASCII 0Ah
<ESC>	: Escape, ASCII 1Bh	␣	: Space, ASCII 20h





20.1. Control commands

Commands to query weighing data

Command	Description
Q	Requests the weighing data immediately
RW	Requests the weighing data immediately
SI	Requests the weighing data immediately
S	Requests the weighing data when stabilized.
<ESC>P	Requests the weighing data when stabilized.
SIR	Requests the weighing data continuously. (Stream output)
C	Cancels the S, <ESC>P, or SIR command.

- The Q, RW, and SI commands have the same function.
- The S and <ESC>P commands have the same function.

Key control commands

Command	Description
P	Same as the [ON:OFF] key  .
ON	Turns the display on.
OFF	Turns the display off.
CAL	Executes the internal sensitivity adjustment.
EXC	Executes the external sensitivity adjustment.
PRT	Same as the [PRINT] button  .
R	Same as the [RE-ZERO] button  .
RZ	
T	Same as the [TARE] button  .
TR	
ZR	Zero: If the load is within $\pm 2\%$ of the capacity from the initial zero point, the zero point is updated, the tare value is cleared and the display is set to zero. If the load exceeds $\pm 2\%$, no processing is done.
RIR	Same as the IR sensor (right).
LIR	Same as the IR sensor (left).
TST	Executes the internal calibration test.

- The R and RZ commands have the same function.
- The T and TR commands have the same function.

Commands to preset the tare value

Command	Description
PT:*.*****_g	<p>Sets the preset tare value.</p> <p>Add the unit in the A&D standard format (3 characters).</p> <p>If the display unit is PCS or percent (%), set the value in grams.</p> <p>In the case of setting the preset tare value to 12.3456 g, the input will be: PT:12.3456 g.</p> <p>Values exceeding the weighing capacity cannot be set. Negative values cannot be set.</p>
?PT	<p>Requests the tare weight value.</p> <p>Outputs the tare value set with the PT, T, or TR command.</p>

Commands to control piece counting

Command	Description
UW:*.*****_g	<p>Sets the unit weight value (weight of one piece).</p> <p>Add the unit in the A&D standard format (3 characters).</p> <p>In the case of setting the unit weight value to 1.23 g, the input will be: UW:1.23 g.</p> <p>Values exceeding the weighing capacity cannot be set. Negative values cannot be set.</p>
?UW	Requests the unit weight value.

Commands to set time and date

Command	Description
TM:**:**:**	<p>Sets time.</p> <p>In the case of setting time to "twelve thirty-four fifty-six seconds", the input will be: TM:12:34:56.</p> <p>Do not set non-existing time values.</p>
DT:**/**/**	<p>Sets date.</p> <p>In the case of setting time to "January 23, 2025", the input will be: DT:25/01/23.</p> <p>Do not set non-existing date values.</p> <p>The command format may vary depending on the date display order. For detailed settings, refer to "13.4. Date/time setting".</p>
?TM	Requests the time.
?DT	Requests the date.

Commands to open and close the door(s)

Command	Description
DR:000	Closes the door(s).
DR:001	Opens the door(s).
?DR	<p>Requests the door status.</p> <p>DR,000 Closed</p> <p>DR,001 Opened</p>

Commands to request other data

Command	Description
?T	Requests the tare weight value. Outputs the tare value set with the T or TR command. The header will be "PT" when the preset tare value is set with the PT command, and "T" when the tare value is set with the T command.
?ID	Requests the ID number.
?SN	Requests the serial number.
?TN	Requests the device name.



20.2. AK code and error codes

When [AK (acknowledge), error code] is set to ON in the [Command settings] screen described in "13.11. Command settings", the balance always responds to reception of all commands sent from a PC or a PLC. Checking the code that is responded improves the reliability of the communication.

Balance response

When [AK (acknowledge), error code] is set to ON, the balance responds as follows.

- ❑ When the balance receives a command requesting data:
 - If the balance can output the data, it sends the requested data.
 - If the balance cannot output the data, it sends an error code (EC, E_{xx}).
- ❑ When the balance receives a control command:
 - The balance will send an AK code (acknowledgment, ASCII 06h) upon confirmation of receipt of the command and completion of the process.
 - If the balance cannot execute the command, it sends an error code (EC, E_{xx}).
- ❑ The following control commands are handled by the balance, which sends an AK code (acknowledgment, ASCII 06h) upon the completion of the process as well as upon confirmation of receipt of the command. If the balance cannot execute the command process, it sends an error code (EC, E_{xx}). To clear the error, use the CAL command.

Command	Description
ON	Turns the display on.
P	Turns the display on/off. (Only when the display is on.)
R, RZ	Same as the [RE-ZERO] button  .
T, TR	Same as the [TARE] button  .
ZR	Zero: If the load is within $\pm 2\%$ of the capacity from the initial zero point, the zero point is updated, the tare value is cleared and the display is set to zero. If the load exceeds $\pm 2\%$, no processing is done.
CAL	Executes internal sensitivity adjustment.
EXC	Executes external sensitivity adjustment.
TST	Executes internal calibration test.
DR:000	Closes the door(s).
DR:001	Opens the door(s).

20.3. Command usage examples

In the following command examples, [AK (acknowledge), error code] is set to ON in the [Command settings] screen described in "13.11. Command settings" so that the balance outputs an AK code (acknowledgment, ASCII 06h) when it processes the command successfully.

ASCII code symbols

CR : Carriage return, ASCII 0Dh

LF : Line feed, ASCII 0Ah

␣ : Space, ASCII 20h

AK : Acknowledgment, ASCII 06h

Example of the ON command (Display ON)

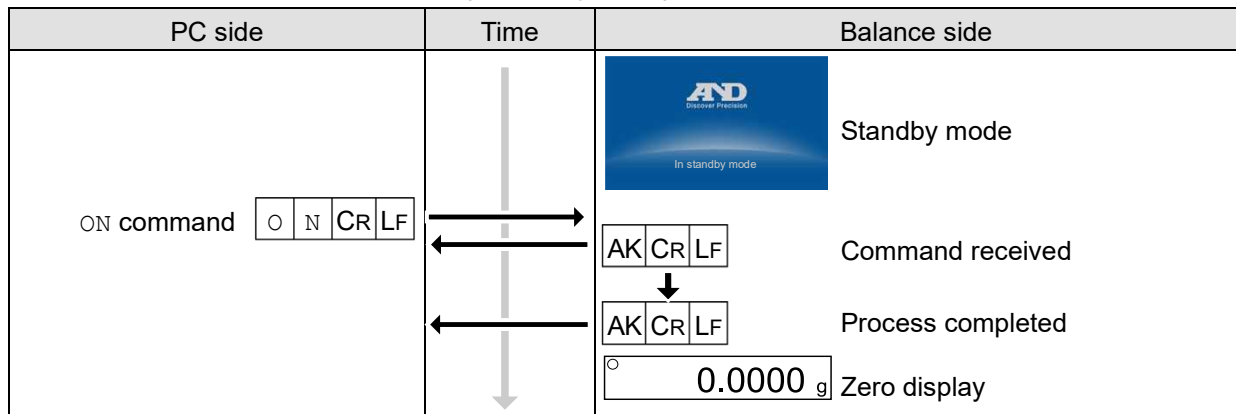

Example of the R command (Re-zero)

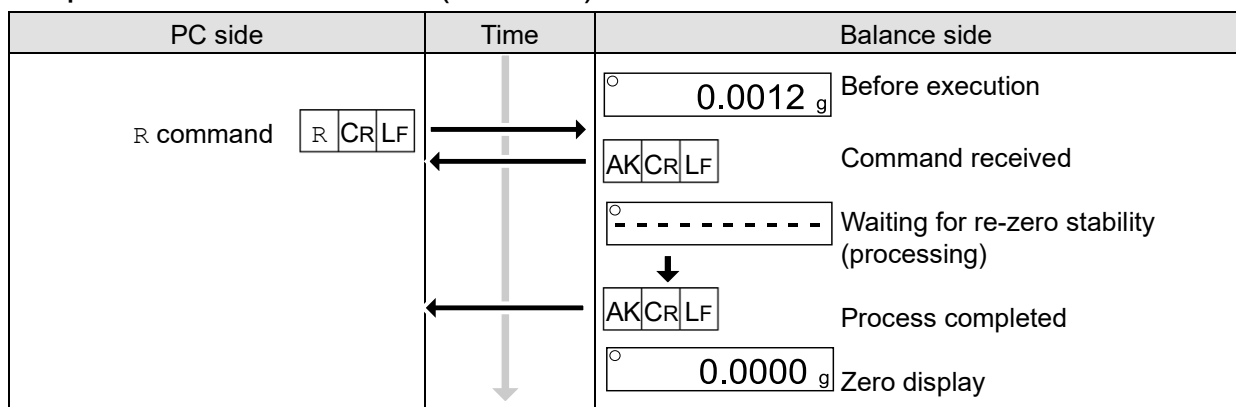

Example of the CAL command

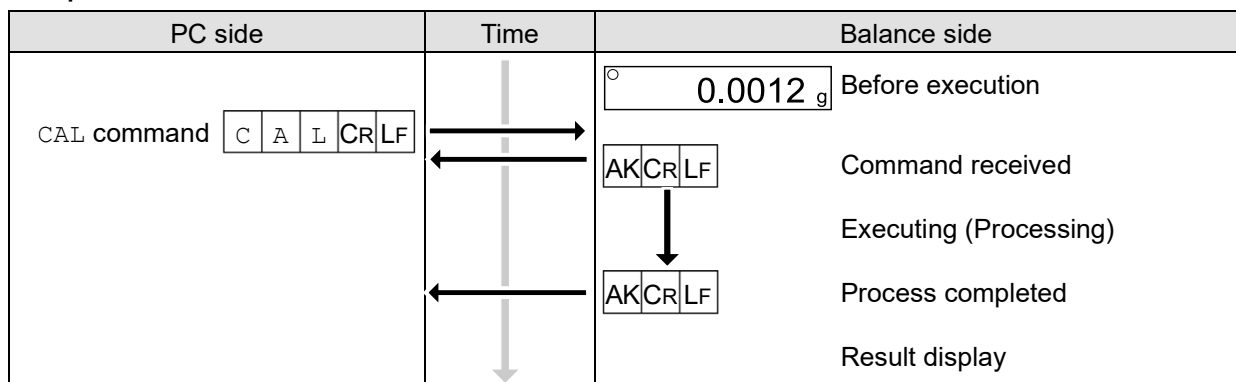

Example of weighing with tare function

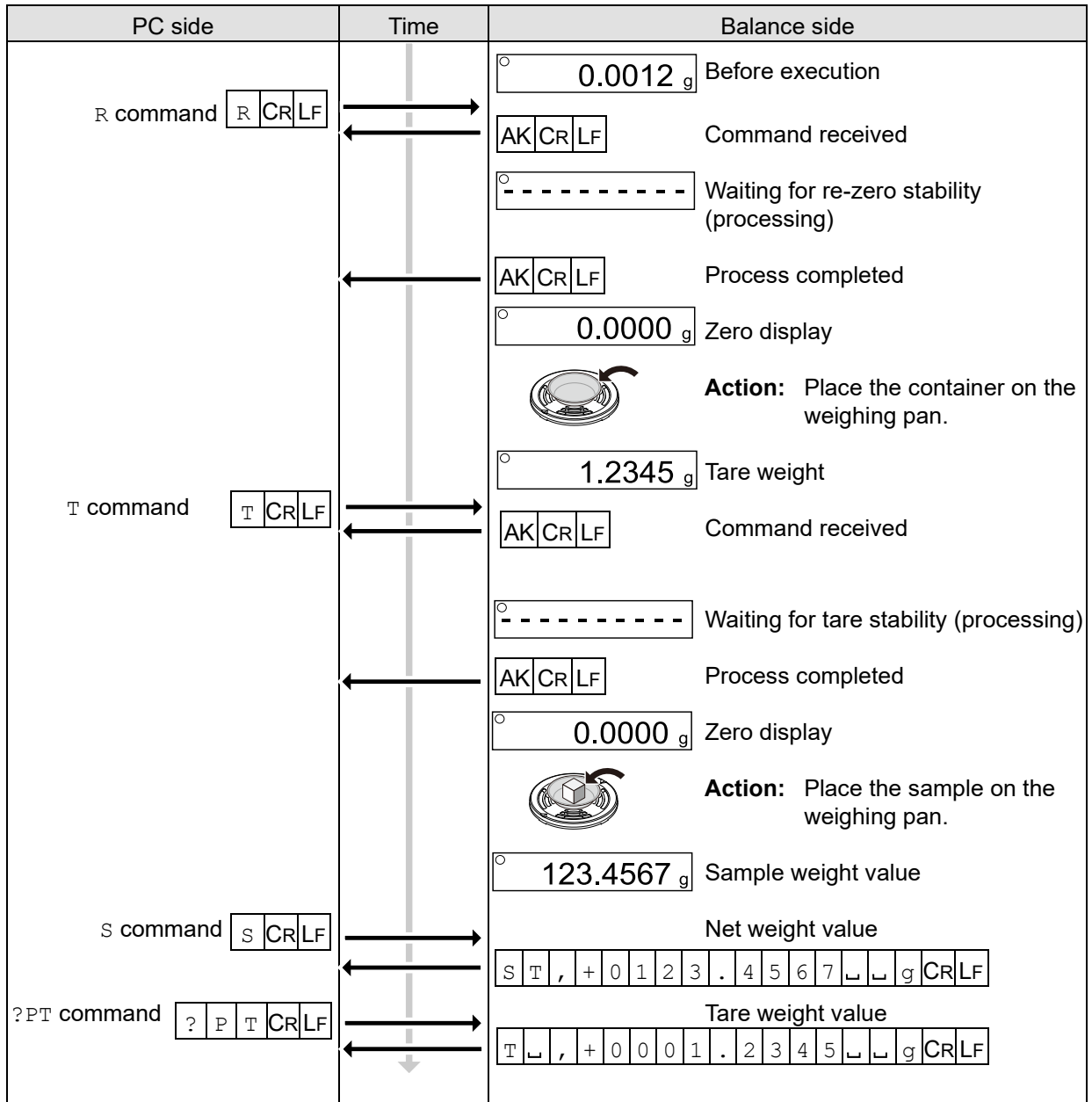

21. UFC Function

- ❑ The Universal Flex Coms (UFC) function allows you to output contents of your choice when outputting the weighing data. You can also output a character string when printing a barcode with a label printer or the like.
- ❑ In order to use the UFC function, it is necessary to set the output data format used to [UFC format]. For the data format settings, refer to "[13.16. RS-232C interface](#)", "[13.17. USB interface](#)", "[13.18. Wired LAN port](#)", and "[13.19. Bluetooth](#)".

21.1. UFC program commands

- ❑ The output data format used can be stored in the balance by sending the program command from a PC.
- ❑ Text files can be imported from a USB flash drive to the internal memory. For the import method, refer to "[13.20. UFC format](#)".
- ❑ The program command received is saved in the internal memory with the filename "Received_Program_Command.txt". The data in the internal memory is retained even when the power of the balance is turned off. However, when the program command is received again, the file will be overwritten.

Creating program commands

- ❑ The maximum number of characters for a program command is 1024 characters.
- ❑ Add the three characters "PF," to the beginning of the program command.
- ❑ Program commands are combined using comma or space delimiters, which can be omitted to reduce the number of characters. The comma after the PF command, however, cannot be omitted.

Program command list

Command	Description	Output examples
PF,	FC command header Added to the beginning of the program command.	
\$MN	Manufacturer name	□ □ □ □ □ □ □ A □ & □ □ D
\$TY	Model name	□ □ □ □ B H - 3 2 4 T E
\$SN	Serial number	□ □ □ □ T 1 2 3 4 5 6 7
\$ID	ID number	S A M P L E - 1 2 3 4 - 5
\$DT	Date	2 0 2 5 / 1 0 / 0 1
\$TM	Time	1 2 : 3 4 : 5 6
\$WT	Weight data	□ □ □ □ + 2 . 3 4 5 6 □ □ g
\$GR	Gross data (gross weight)	□ □ □ + 1 2 . 3 4 5 6 □ □ g
\$NT	Net data (net weight)	□ □ □ □ + 2 . 3 4 5 6 □ □ g
\$TR	Tare data (tare weight)	□ □ □ + 1 0 . 0 0 0 0 □ □ g
\$PC	Counting data	□ □ □ □ □ □ + 1 2 3 4 □ P C
\$UW	Unit weight data	□ □ □ □ + 0 . 1 2 3 4 □ □ g
\$CM	Comma	,
\$SP	Space, ASCII 20h	□
\$CR	Carriage return, ASCII 0Dh	CR
\$LF	Line feed, ASCII 0Ah	LF
\$NU	Outputs a weighing value in the NU2 format	0 . 2 3 4 5
\$HT	Outputs a tab	TAB

- ❑ Enclose an ASCII code string of your choice in single quotation marks. The output string can include alphanumeric characters and symbols. The single quotation mark is represented by two single quotation marks.
Example: To output the string "A'BC'D", enter 'A' 'BC' 'D'.
- ❑ To output the ASCII control code, enter "# + 2 hexadecimal characters"
However, SOH (01h), STX (02h), ETX (03h), and EOT (04h) cannot be used.
Example: To output the ASCII code "acknowledgement, AK (06h)", enter #06.
- ❑ By adding '*' and a number (up to 2 characters)' after the command, space (\$SP), CR (\$CR), LF (\$LF), and TAB (\$HT) can be repeated as many times as the number entered.
Example: To output 12 spaces, enter \$SP*12.
To output 9 carriage returns, enter \$CR*9.
- ❑ By adding '&' to the end of a line when sending two or more lines of program command, the balance determines that the program command will continue on the next line.
- ❑ The balance sends an code (acknowledgement, ASCII 06h) at the end of the process. If the command cannot be executed, an error code (EC, E_{xxx}) will be sent.
- ❑ The software "Windows Communication Tools for UFC" ("WinCT-UFC") for creating program commands is available.
Download "WinCT-UFC" from the A&D website (<https://www.aandd.jp>).

ASCII code symbols

CR	: Carriage return, ASCII 0Dh	LF	: Line feed, ASCII 0Ah
␣	: Space, ASCII 20h	AK	: Acknowledgment, ASCII 06h

21.1.1. Examples of UFC program command creation

Note

- ❑ See the previous page for the meanings of UFC commands and symbols.
For the data output format, refer to "19. Data Output".
The following examples "SAMPLE01.txt" and "SAMPLE02.txt" are saved in the Balance's memory.

Example 1 SAMPLE01.txt

Output	Output content	Program command example
NET	Character string 'NET', Line feed	PF, 'NET', \$CR, \$LF, &
␣␣␣+20.0000␣␣g	Net Data, Newline	\$NT, \$CR, \$LF, &
TARE	Character string 'TARE', Line feed	'TARE', \$CR, \$LF, &
␣␣+123.4567␣␣g	Tare data, Newline	\$TR, \$CR, \$LF, &
GROSS	Character string 'GROSS', Line feed	'GROSS', \$CR, \$LF, &
␣␣+143.4567␣␣g	Gross data	\$GR, \$CR, \$LF
		Terminator

␣ " represents a space.

Example 2 SAMPLE02.txt

Output	Output content	Program command example
2025/01/23␣␣15:47:33	Date, Space, Space, Time, Newline	PF, \$DT, \$SP, \$SP, \$TM, \$CR, \$LF, &
SAMPLE␣␣␣␣␣␣␣␣␣ABC-123	Character string 'SAMPLEABC-123',	'SAMPLE␣␣␣␣␣␣␣␣␣ABC-123', \$CR, \$LF, &
WEIGHT␣␣+143.4567␣␣g	Line feed␣␣␣␣␣␣␣␣␣	'WEIGHT', \$WT, \$CR, \$LF
	Character string 'WEIGHT', Weighing data	Terminator

␣ " represents a space.

22. Key Lock Function

- ❑ The key switches of the balance and the IR sensor functions can be locked by sending a specified command to the balance. This is a useful function when you want to control the balance only with an external device such as a PC.
Even in the key lock state, it is possible to operate the keys with the key control commands. For the key control commands, refer to "20. Command".
- ❑ The key lock state can be checked by sending a status check command to the balance.
- ❑ The key lock is maintained until a release command is sent to the balance or the power is turned off by unplugging the AC adapter.
- ❑ The key lock command operates only on the [HOME] screen (weighing mode, counting mode, percent mode, minimum weight alert function). Although the key lock command operates in formulation mode, HPLC mode, and density measurement mode, you cannot operate the balance with the command (the [SAVE] button  or recipe selection).

CAUTION

- ❑ The IR sensor settings cannot be changed in the key lock state.

22.1. Locking all key switches

All the key switches of the balance can be disabled by sending a `KL` command to the balance.

Command string	Description
?KL	Requests key lock state. KL,000 All keys unlocked. KL,001 All keys locked.
KL:****	In place of *** 000 or 001 is entered. KL:000 Unlock all keys. KL:001 Lock all keys.







22.2. Sensitivity adjustment while the keys are locked

The following commands are enabled on the sensitivity adjustment screen while the keys are locked.

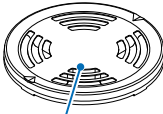
Command string	Description
NEXT	Confirms the current input setting and proceeds to the next instruction. Operates the same as the [Enter] button  .
BACK	Displays the [HOME] screen. Operates the same as the [Back] button.

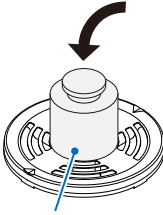
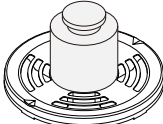
22.2.1. Procedure for external sensitivity adjustment while the keys are locked

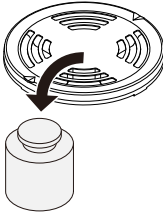
Weighing example for BH-324TE

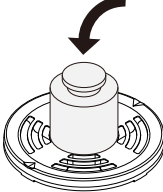
Step	Description	Display and command operations	Weighing operation
1	<p>Make sure that nothing is on the weighing pan, and then send the [NEXT] command.</p> <p>The balance measures the zero point.</p> <p>Do not apply vibration and the like to the balance.</p> <p>Note: You can input the external weight value before input.</p>	<p>[NEXT] command</p> 	 <p>Weighing pan</p>
2	<p>Place the weight on the weighing pan, and then send the [NEXT] command.</p> <p>Measure the weight.</p> <p>Do not apply vibration and the like to the balance.</p> <p>Note: You can input the external weight value before input.</p>	 <p>[NEXT] command</p> 	 <p>Weight</p> 
3	<p>The [Sensitivity adjustment result] screen for the external sensitivity adjustment is automatically displayed.</p> <p>Remove the weight.</p>		
4	<p>The result screen is displayed.</p> <p>Note: It is automatically output if either [GLP output] or [GLP custom output] is set for [GLP output/Label output].</p>		
5	<p>Send the [BACK] command to return to the weighing screen.</p> <p>Place the weight again to confirm that the sensitivity of the balance is adjusted properly.</p> <p>If it is not within the range, start over from the first step of this procedure in the appropriate ambient conditions.</p>	<p>[BACK] command</p>	

23. Ionizer

The ionizer removes static electricity by irradiating the target object with positive or negative ions that are generated from four discharge electrodes by DC corona discharge. Ordinarily, insulators such as powders, filters, or weighing paper, tend to be charged when the humidity is 45% RH or less, and an error of a few milligrams may occur during weighing. By removing static from the weighing object with the ionizer, it is possible to eliminate the error in the weighing value due to charging, and correct weighing can be performed.

23.1. Using the ionizer

Step	Description
1	Connect the AC adapter, plug it in, and turn on the power. The power lamp on the ionizer will light up.
2	Place the target object within the effective range of static elimination.
3	Hold your hand over the IR sensor (touchless infrared proximity sensor) on the front of the ionizer to start static elimination. The ION lamp will light up, indicating that static elimination is in progress.
4	Refer to the figure below for the effective range of static elimination, and perform static elimination. By default, static elimination will stop, and the ION lamp will turn off 3 seconds after the start of static elimination.

Ionizer AD-1683A

IR sensor (touchless infrared proximity sensor)

Power lamp (lights up when the power is turned on)

Power lamp (lights up during static elimination)

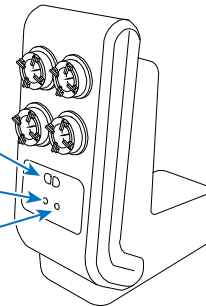

Effective range of static elimination

Top view

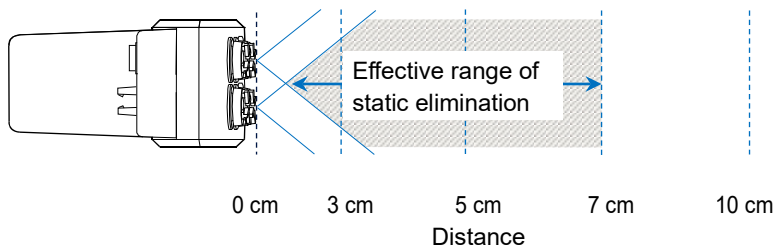

Side view

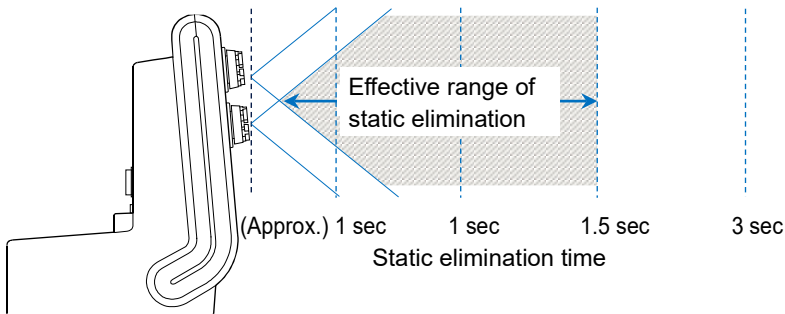
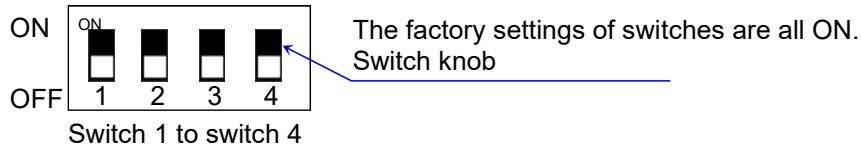

Figure. Static elimination range

23.2. Optimizing the ionizer

Static elimination method can be optimized with the switches on the rear. Refer to the following table for the functions of switches.

When eliminating static electricity outside the effective range, adjust the settings of switch 1 and switch 2. For the effective range, refer to [Effective range of static elimination](#) ("23.1. Using the ionizer").



The factory settings of switches are all ON (upper side). It means static elimination method is in 'timer mode,' 'discharging time' is for 3 seconds, and 'built-in IR sensor' and 'buzzer' are available.

Switch No. / Item	Switching location		Description
Switch 1 Static elimination method	ON	Upper side	Timer mode ^{*1}
	OFF	Lower side	Manual mode ^{*2}
Switch 2 Static elimination time ^{*3}	ON	Upper side	3 seconds
	OFF	Lower side	10 seconds
Switch 3 Built-in IR sensor	ON	Upper side	Available
	OFF	Lower side	Not available
Switch 4 Buzzer ^{*4}	ON	Upper side	Available
	OFF	Lower side	Not available

^{*1} When the 'timer mode' is selected with switch 1, static elimination is performed for the 'discharging time' set with switch 2.

^{*2} When the 'manual mode' is selected with switch 1 and static elimination starts, it continues until the built-in IR sensor or the optional IR switch performs again. The 'manual mode' does not stop static elimination automatically.

^{*3} Discharging time is settable only when the static elimination mode is in the 'timer mode' (switch 1 is on).

^{*4} Buzzer rings when the power is turned on or whenever the IR sensor or IR switch performs.

23.3. Maintaining the ionizer

CAUTION

- ❑ Do not touch electrode units while the ionizer is in operation. Doing so may result in electric shock.
- ❑ Dust and other substances adhere to the electrode needle area of the ionizer over time, degrading the static elimination capacity.
To maintain the performance, clean the electrode needle on electrode units with a dry cotton swab, etc. on a regular basis.
- ❑ If the static elimination capacity does not recover because the tip of the electrode needle on an electrode unit is worn out, replace all of the four electrode units with new ones. The lifetime of electrode units is approx. 10000 hours.

Replacement procedure

Step	Description
1	Disconnect the balance connection cable and turn off the power.
2	Rotate electrode units counterclockwise by 45° to pull them out.
3	Insert new electrode units and rotate them clockwise by 45° to secure them.

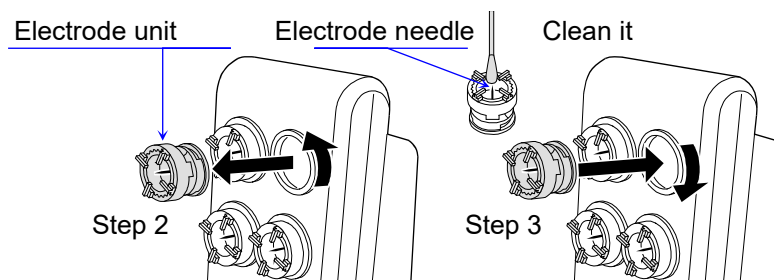





24. Maintenance

24.1. Treatment of the balance

- Do not use organic solvents, alcohol, or chemical cleaning cloths.
- Do not disassemble the balance.
- When transporting the balance, use the packing material and box that the balance was contained at the time of purchase.

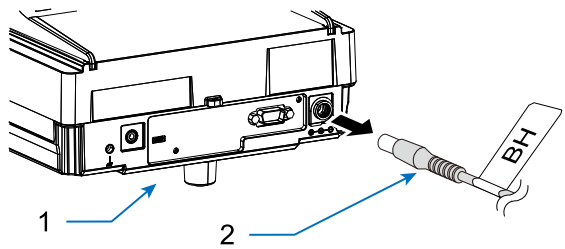
Main unit	Use the included cleaning brushes to remove dust from the main unit. For oil stains, use a soft, lint-free cloth dampened with a neutral detergent.
Breeze break	The breeze break components are treated with an anti-static coating. Wipe them with a soft, lint-free cloth.
Weighing pan	The weighing pan is made of stainless steel. When cleaning, be careful not to injure your hands on the edges.

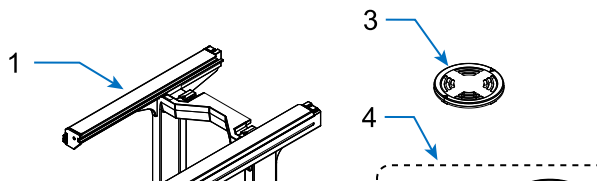
Cleaning method

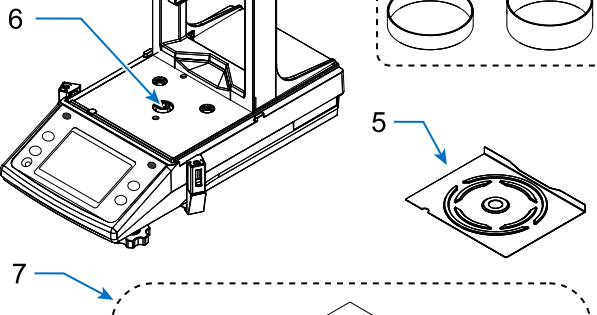
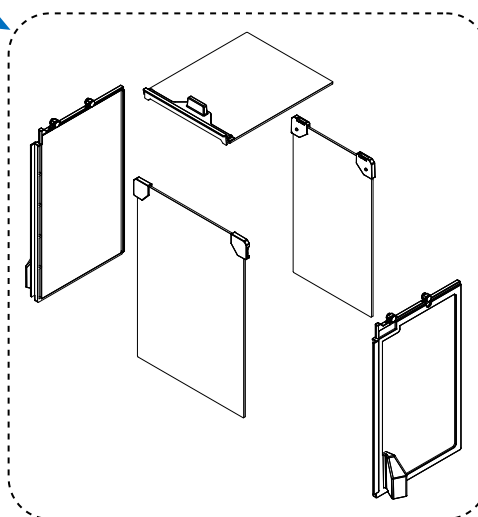
Step	Description	Parts diagram
1	Disconnect the AC adapter plug (2) from the main unit (1).	
2	Remove the breeze break glass panes (7) from the main unit (1) and clean the glass.	
3	Remove the weighing pan (3), breeze break rings (4), and breeze break bottom plate (5), and clean the top surface of the main unit (1).	
4	<p>Do not apply force to the pan support boss (6) during cleaning.</p> <p>Be careful not to let dust or debris enter the main unit through the hole in the pan support boss.</p> <p> Do not remove the stickers attached to the main unit during cleaning.</p>	
5	After cleaning is complete, refer to "2.2. Assembly and installation " for setup.	

- 1 Main unit
- 2 AC adapter plug
- 3 Weighing pan
- 4 Breeze break rings
- 5 Breeze break bottom plate
- 6 Pan support boss
- 7 Breeze break glass panes

25. Troubleshooting

25.1. Checking the balance performance and environment

- ❑ Since the balance is a precision instrument, in some cases it may not be able to measure correct values due to adverse effects of the measurement environment or measurement method.
If repeatability is poor when the sample is loaded and unloaded several times, or if the balance seems to be operating abnormally, check the following items. If the problem persists after checking each item, contact your local A&D dealer for repair. "Frequently Asked Questions" and answers to them are also posted on the A&D website (<https://www.aandd.jp>).

1. Checking that the balance works properly

Method 1: Use check functions to check the balance operation. Refer to "11.1. Daily check" and "11.2. Periodic check". Fatal failures are displayed as a message.

Method 2: As a simpler test, check the repeatability with an external weight.
Be sure to place the weight in the center of the weighing pan.

Method 3: As a precise test, check the repeatability, linearity, weighing value, etc. with a weight of a known weight.

2. Checking that the measurement environment and method are appropriate

Check the following check items.

Operating environment

- ❑ Is the table on which the balance is placed sturdy?
- ❑ Is the balance level? For how to adjust the bubble spirit level, refer to "2.4. How to adjust the level of the balance".
- ❑ Is the operating environment free from vibration and drafts?
- ❑ Is there any strong electrical or magnetic noise source such as a motor near the balance?

Weighing method

- ❑ Is the weighing pan set so that it does not touch other parts such as the breeze break and dust plate frame? (Is it installed correctly?)
- ❑ Do you always press the [RE-ZERO] button before placing your sample on the weighing pan?
- ❑ Do you place your sample in the center of the weighing pan?
- ❑ Did you perform a sensitivity adjustment before weighing?
- ❑ Did you warm up the balance before weighing for at least an hour with the AC adapter connected to the power supply?

Sample and container

- ❑ Is the sample free from moisture absorption or evaporation due to the influence of ambient temperature and humidity?
- ❑ Is the temperature of the container of the sample acclimatized to the ambient temperature? Refer to "2.5. Precautions during use for more accurate weighing".
- ❑ Is the sample free of static electricity? Refer to "2.5. Precautions during use for more accurate weighing".
- ❑ Is the sample a magnetic material (iron, etc.)? Care must be taken when weighing magnetic materials. Refer to "2.5. Precautions during use for more accurate weighing".

25.2. Error displays (error codes)

Display	Error code	Description and possible countermeasure
Weighing display E		Overload error The weighing value exceeds the balance's weighing capacity. Remove the object from the pan.
Weighing display -E		Weighing pan error The weighing value is too light. The weighing pan is not set correctly. Set the weighing pan correctly. Perform a sensitivity adjustment.
LoWVoLt		Power supply voltage fault The voltage supplied from the AC adapter is abnormal. Check that the AC adapter is the one supplied with the balance (" 26. Specifications ").
Error 1	EC, E11	Stability error Weighing value is unstable and therefore the "zero display", "sensitivity adjustment", "calibration test", etc. cannot be executed. Check around the pan. Improve the environment of the installation location to prevent factors such as vibration, draft, temperature change, static electricity and magnetic field from influencing the balance. Wait for 10 seconds to clear the error.
Error 2		Entry value error The value to be set exceeds the setting range. Set again within the setting range.
Error 6	EC, E16	Internal weight error Applying the internal weight does not yield a change in the mass value as specified. Confirm that there is nothing on the pan and perform the operation from the beginning. If this error continues to be displayed, repair is necessary.
Error 7	EC, E17	Internal weight error The internal weight application mechanism does not function properly. Perform the operation from the beginning. If this error continues to be displayed, repair is necessary.
CAL E	EC, E20	Calibration weight error (Positive value) The calibration weight is too heavy. Check around the pan. Check the calibration mass value.
-CAL E	EC, E21	Calibration weight error (Negative value) The calibration weight is too light. Check around the pan. Check the calibration mass value.
Weighing display Lo		Sample mass error The sample is too light to be stored as a sample mass for the counting mode or percent mode.
SD Error		Repeatability error <input type="checkbox"/> SD Error The standard deviation (SD) of repeatability has exceeded 50 d. Review the installation environment of the balance. "d" is a unit of readability.

Display	Error code	Description and possible countermeasure
rtc PF		<p>Clock battery error</p> <p>The clock backup battery has been depleted. Set the time and date. Even if the clock backup battery is depleted, the clock and calendar function work normally as long as the balance is powered with the AC adapter. If this error appears frequently, please contact your local A&D dealer.</p>
Door Err		<p>Breeze break unit error</p> <p>The breeze break auto doors are not functioning properly. Ensure there are no obstructions preventing the breeze break auto door(s) from opening and closing, then perform the door test ("13.3. Breeze break auto doors").</p> <p>If the issue persists, repair is required.</p>
Error 3		<p>Malfunction of the internal memory element of the balance</p> <p>If this error continues to be displayed, repair is necessary. Please contact your local A&D dealer for repair.</p>
Error 8		<p>Abnormality in the internal memory data of the balance</p> <p>If this error continues to be displayed, repair is necessary. Please contact your local A&D dealer for repair.</p>
Error 9		<p>Abnormality in the internal memory data of the balance</p> <p>If this error continues to be displayed, repair is necessary. Please contact your local A&D dealer for repair.</p>
	EC, E00	<p>Communications error</p> <p>A protocol error occurred in communication. Check the format, baud rate, etc.</p>
	EC, E01	<p>Undefined command error</p> <p>An undefined command was found. Check the transmitted command.</p>
	EC, E02	<p>Not ready</p> <p>The received command cannot be executed.</p> <p>(e.g.) Q command was received when not in weighing mode.</p> <p>(e.g.) Q command was received while re-zeroing.</p> <p>Adjust the delay time for transmitting a command.</p>
	EC, E03	<p>Timeout error</p> <p>With the command timeout setting, there was a wait time of approximately 1 second or more while receiving command characters. Check the communication.</p>
	EC, E04	<p>Character length error</p> <p>The number of characters in the received command has exceeded the limit. Check the command to transmit.</p>
	EC, E06	<p>Format error</p> <p>The description of the received command is incorrect.</p> <p>(e.g.) The number of digits of numerical values is incorrect.</p> <p>(e.g.) There are alphabet characters among the numerical values.</p> <p>Check the transmitted command.</p>

Display	Error code	Description and possible countermeasure
	EC,E07	Parameter setting error The value of the received command has exceeded the allowed value. Check the setting range of the numerical value of the command.
Other error displays		If the errors described above cannot be released or other errors are displayed, please contact your local A&D dealer.

25.3. Asking for repair

If any issues occur after verifying the balance's operation, or if error displays indicating repairs being required appear, please contact your local A&D dealer. The balance is a precision instrument. Handle it with care during transport.

- When transporting the balance, use the packing materials and box that the balance was originally packed in when purchased.
- Remove the weighing pan and pan support from the main unit before transporting.

26. Specifications

26.1. Common specifications

26.1.1. Function

Internal weight	Approx. 200 g	*1
Ionizer (static eliminator)	Detached type	
Sensitivity drift (10 °C to 30 °C)	±2 ppm/°C (Automatic sensitivity adjustment OFF)	
Operating environment	5 °C to 40 °C, 85%RH or less (no condensation)	
Environment sensor	Measurement accuracy: Temperature ±1.5 °C, relative humidity ±10 %, barometric pressure ±10 hPa Applicable temperature range: 5 °C to 40 °C	
Display refresh rate	5 times/second or 10 times/second	
Counting mode	Number of samples	10 to 100 pcs
Percent mode	Readability	0.01%, 0.1%, 1% (Automatically changed by 100% reference mass)
Communication	RS-232C (printer, PLC, etc.), USB type A (USB flash drive, for data storage), USB type C (PC), LAN (TCP/IP), Bluetooth (PC, etc.). Stereo jack (external switch)	
Power (AC adapter)	Confirm that the adapter type is correct for the local voltage and power receptacle type. Power consumption: approx. 36 VA (including the AC adapter).	

*1 The internal weight may change in mass due to the usage environment and deterioration over time.

26.1.2. Size/weight

Weighing pan size	φ90 mm
Main body weight	Approx. 8 kg
External dimensions	265 (W) × 442 (D) × 381 (H) mm
Ionizer	68 (W) × 129 (D) × 162 (H) mm

26.2. Individual specifications

	BH-225TE	BH-225DTE
Weighing capacity	220 g	220 g
		51 g
Maximum display	220.00084 g	220.0008 g
		51.00009 g
Readability	0.01 mg (0.00001 g)	0.1 mg (0.0001 g)
		0.01 mg (0.00001 g)
Repeatability Standard deviation (measuring point)	0.015 mg (50 g) 0.03 mg (200 g)	0.1 mg (200 g)
		0.025 mg (50 g)
Linearity	±0.10 mg	±0.2 mg
Stabilization time FAST setting, good environment	Approx. 7 seconds	Approx. 3 seconds
		Approx. 7 seconds
Counting mode Minimum unit weight	0.1 mg	
Percent mode Minimum 100% reference mass	10.0 mg	
Applicable weights for calibration test/sensitivity adjustment	Any weight between 10 g and 200 g (factory setting: 200 g)	

	BH-224TE	BH-324TE
Weighing capacity	220 g	320 g
Maximum display	220.0084 g	320.0084 g
Readability	0.1 mg (0.0001 g)	
Repeatability Standard deviation (measuring point)	0.09 mg	0.1 mg
Linearity	±0.2 mg	
Stabilization time FAST setting, good environment	Approx. 3 seconds	
Counting mode Minimum unit weight	0.1 mg	
Percent mode Minimum 100% reference mass	10.0 mg	
Applicable weights for calibration test/sensitivity adjustment	Any weight between 10 g and 200 g (factory setting: 200 g)	Any weight between 10 g and 300 g (factory setting: 200 g)

26.3. External dimensions

When the breeze break top glass pane is fully open

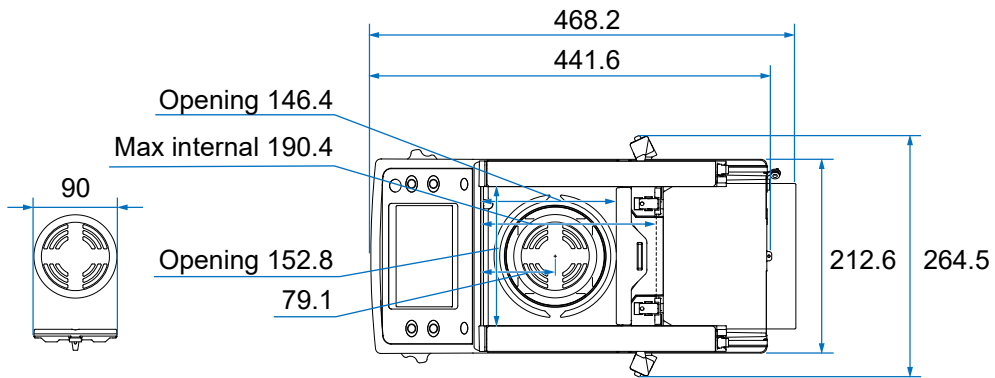

247.8 mm, height above the pan

Opening approx. 140 mm, full open by auto door
Opening 149.1

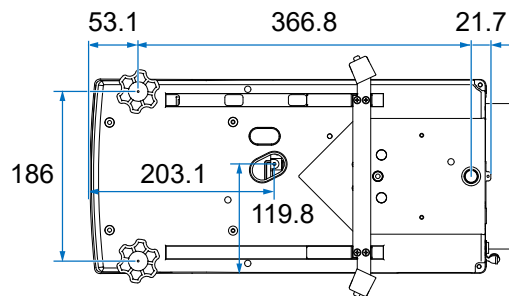
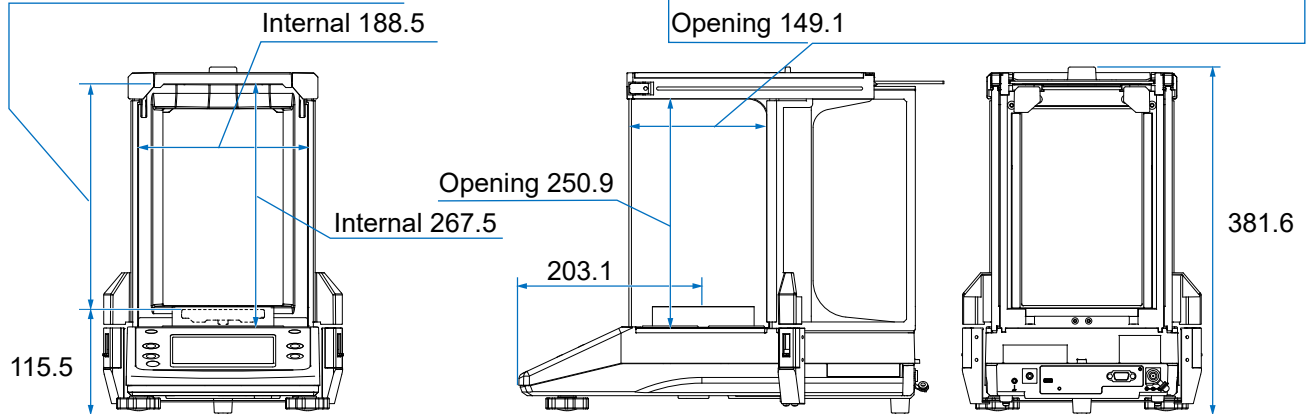

Ionizer

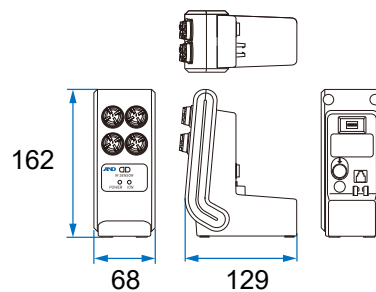

Unit: mm

27. Peripherals

AX-BHT-31: Display cover for BH-T series (a set of 5 pcs)

- Transparent PET display covers (standard accessory).

AD-8127: Multi-functional compact printer

- A small dot impact printer that connects with the balance via the RS-232C interface.
- Receives and prints data output from the balance in dump printing mode.

(For details, refer to the [AD-8127 Instruction Manual](#).)

AD-8129TH: Compact thermal printer

- A small direct thermal printer that connects to the balance via the RS-232C interface.
- Receives and prints data output from the balance in dump printing mode.

(For details, refer to the [AD-8129TH Instruction Manual](#).)

AD-8920A: Remote display

- Connects to the balance via the RS-232C interface to display the weighing value.

(For details, refer to the [AD-8920A Instruction Manual](#).)

AD-8922A: Remote controller

- Connects to the balance via the RS-232C interface to display the weighing value. Performs the balance's key operations.

(For details, refer to the [AD-8922A Instruction Manual](#).)

AD-1683A: Ionizer

- AC adapter (standard accessory)
- Prevents weighing errors caused by static charges on the sample.
- Ideal for precise weighing of powders and the like using the DC method to generate a high volume of ions without airflow.
- Allows touchless static elimination by operating via an infrared sensor.

(For details, refer to the [AD-1683A Instruction Manual](#).)

AD-1684A: Electrostatic field meter

- Measures the electrostatic charge of measured objects or peripheral devices such as containers or breeze breaks for the balance (on automated measuring lines and similar setups) and displays the measurement results. For elimination of charged static electricity, use the AD-1683A (ionizer).

AD-1687: Weighing environment logger

- A data logger equipped with four sensors for temperature, humidity, barometric pressure and vibration that can measure and store environmental data.
- Allows recording of environmental data along with weighing data when connected to the balance via the RS-232C interface.

(For details, refer to the [AD-1687 Instruction Manual](#).)

AD-1688: Weighing data logger

- When connected to the RS-232C interface of the balance, the AD-1688 can store the data.
 - Convenient for recording data in places where a PC cannot be used.
- (For details, refer to the [AD-1688 Instruction Manual](#).)

AD-8541-SCALE: RS-232C to Bluetooth® converter

- Connects the balance to a smartphone, tablet, or PC via Bluetooth, with a maximum communication distance of 10 meters. A dedicated app, "WinCT-WeiV", is available for smartphones and tablets.
 - For connection to a PC, use the AD-8541-SCALE together with the AD-8541-PC (listed below) on the PC side.
- (For details, refer to the [AD-8541-SCALE Instruction Manual](#).)

AD-8541-PC: Bluetooth® dongle for PC

- Connects the balance to a PC via Bluetooth, with a maximum communication distance of 10 meters. Use together with the AD-8541-SCALE (listed above).
- (For details, refer to the [AD-8541-PC Instruction Manual](#).)

AX-SW137-PRINT: Foot switch for PRINT

- An external switch that functions the same way as the [PRINT] key.

AX-SW137-REZERO: Foot switch for RE-ZERO

- An external switch that functions the same way as the [RE-ZERO] key.

AD-1671: Anti-vibration table for balances

- A tabletop anti-vibration table made of natural granite. Its body weight of approximately 27 kg, and rubber cushioning material can reduce vibrations transmitted from the installation table to the balance, minimizing fluctuations in the display caused by vibrations

AD-1689: Tweezers for sensitivity adjustment weight

- A pair of tweezers ideally suited for holding sensitivity adjustment weights of 1 g to 500 g.

AX-KO2741-180: RS-232C cable 1.8m (D-sub 9-pin female - D-sub 9-pin female)

- Cable for connecting the balance and a PLC or the like.

AX-KO7919-200: USB cable 2 m (Type A - Type C)

- USB cable (standard accessory)

AX-USB-9P: USB converter

- Converts the RS-232C interface to USB.
- Driver installation is required.

(For details, refer to the [AX-USB-9P Instruction Manual](#).)

AX-BM-NEEDLESET: Discharge electrode units for the ionizer (a set of 4 pcs)

- Electrode replacement unit for the ionizer.
- When replacing, replace the four pieces at the same time.
- The instruction manual can be downloaded from the A&D website (<https://www.aandd.jp>).

AD-1653: Density determination kit

- Allows for easy measurement of the density of solids and liquids.

28. Compliance

28.1. Compliance with FCC rules

This device contains transmitter module FCC ID: 2A6NFEC2832

This device complies with part 15 of the FCC Rules. Operation is subject to the following two conditions:

(1) This device may not cause harmful interference, and (2) this device must accept any interference received, including interference that may cause undesired operation. (FCC = Federal Communications Commission in the U.S.A.)

FCC CAUTION: Changes or modifications not expressly approved by the party responsible for compliance could void the user's authority to operate the equipment. The antenna used for this transmitter must not be co-located or operating in conjunction with any other antenna or transmitter. This product is certified as type of the portable device with FCC Rules. To maintain compliance with RF Exposure requirement, please use within specification of this product.

28.2. IC

IC RADIATION EXPOSURE STATEMENT FOR CANADA

This device contains transmitter module IC: 28568-EC2832

This device complies with Innovation, Science and Economic Development Canada license-exempt RSS standards. Operation is subject to the following two conditions: (1) This device may not cause interference. (2) This device must accept any interference, including interference that may cause undesired operation of the device.

Le présent appareil est conforme aux CNR Innovation, Sciences et Développement économique Canada applicables aux appareils radio exempts de licence. L'exploitation est autorisée aux deux conditions suivantes: 1) l'appareil ne doit pas produire de brouillage; 2) l'utilisateur de l'appareil doit accepter tout brouillage radioélectrique subi, même si le brouillage est susceptible d'en compromettre le fonctionnement.

28.3. Bluetooth®

The Bluetooth® word mark and logos are registered trademarks owned by Bluetooth SIG, Inc. and any use of such marks by A&D is under license.

Other trademarks and trade names are those of their respective owners.