

## Instruction Manual (Operation)

COMPACT WATER QUALITY METER  
LAQUAtwin-NO3-11, LAQUAtwin-NO3-11C,  
LAQUAtwin-NO3-11S

## Specifications

|                       |  |
|-----------------------|--|
| Model                 | LAQUAtwin-NO3-11, LAQUAtwin-NO3-11C, LAQUAtwin-NO3-11S   |
| Target                | Nitrate ion (NO <sub>3</sub> <sup>-</sup> )  |
| Measurement principle | ISE method   |
| Minimum sample volume | More than 0.3 mL*1   |
| Intended use          | LAQUAtwin-NO3-11:<br>General measurement<br>LAQUAtwin-NO3-11C:<br>Crop measurement<br>LAQUAtwin-NO3-11S:<br>Soil measurement |
| Measurement range     | NO <sub>3</sub> <sup>-</sup> : 6 to 9900 [unit: ppm or mg/L]   |
|                       | NO <sub>3</sub> <sup>-</sup> -N: 0.7 to 1100 [unit: kg/10a]  |
|                       | NO <sub>3</sub> <sup>-</sup> -N: 1.4 to 2200 [unit: ppm or mg/L]   |
| Resolution (default)  | Display range (NO <sub>3</sub> <sup>-</sup> ): Resolution  |
|                       | 6 to 99: 1   |
|                       | 100 to 990: 10   |
|                       | 1000 to 9900: 100  |
|                       | [unit: ppm or mg/L]  |
| Calibration           | Up to 2 points   |
|                       | Default:   |
|                       | LAQUAtwin-NO3-11:<br>150 ppm and 2000 ppm  |
|                       | LAQUAtwin-NO3-11S:<br>30 ppm and 300 ppm   |
|                       | LAQUAtwin-NO3-11C:<br>300 ppm and 5000 ppm   |
| Accuracy*2            | ±10% of reading value  |

|                       |   |
|-----------------------|---|
| Waterproof            | IP67 (no failure when immersed in water at a depth of 1 m for 30 min)*3               |
| Display               | Custom (monochrome) digital LCD with backlight  |
| Operating environment | Temperature: 5°C to 40°C<br>Humidity: 85% relative humidity or less (no condensation) |
| Power                 | CR2032 batteries (×2)   |
| Battery life          | Approx. 400 h continuous operation (backlight off mode)*4                             |
| Material              | ABS epoxy (main material)   |
| Dimensions            | 164 × 29 × 20 mm (excluding projections)  |
| Mass                  | Approx. 50 g (excluding batteries)  |

\*1 0.05 mL or more if sampling sheet B (sold separately) is used.

\*2 The closeness of agreement between a measured value and an actual value of standard solution after two-point calibration using the standard solutions of the same concentration as provided in the package.

- The standard solution used for the later calibration was measured.
- The calibration and measurement are performed at the same temperature.
- The error of standard solutions and rounding error (±1 digit) are not included.

\*3 The meter cannot be used underwater.

\*4 When the backlight is used, battery life will shorten.

### Items in package

| Items        | Quantity |      |      |
|--------------|----------|------|------|
|              | 11*      | 11C* | 11S* |
| Sensor       | S040     |      |      |
| Meter        | 1        |      |      |
| Storage case | 1        |      |      |
| Batteries    | CR2032   |      |      |
|              | 2        |      |      |

| Items                           |          | Quantity |      |            |
|---------------------------------|----------|----------|------|------------|
|                                 |          | 11*      | 11C* | 11S*       |
| Standard solution               | 150 ppm  | 1        | 0    | 0          |
|                                 | 2000 ppm | 1        | 0    | 0          |
|                                 | 30 ppm   | 0        | 0    | 1          |
|                                 | 300 ppm  | 0        | 1    | 1          |
|                                 | 5000 ppm | 0        | 1    | 0          |
| Pipette                         |          | 1        |      |            |
| Sampling sheet B                |          | 5 sheets | 0    | 100 sheets |
| Instruction manual (Operation)  |          | 1        |      |            |
| Instruction manual (Before use) |          | 1        |      |            |

\* The model names are abbreviated on the column headers.

11: LAQUAtwin-NO3-11  
11C: LAQUAtwin-NO3-11C  
11S: LAQUAtwin-NO3-11S

### Consumable parts sold separately

| Items             | Specifications                              | Part No.   |
|-------------------|---|------------|
| Sensor            | S040, NO <sub>3</sub> <sup>-</sup>          | 3200459870 |
| Standard solution | Y045, NO <sub>3</sub> <sup>-</sup> 150 ppm  | 3200053536 |
|                   | Y043, NO <sub>3</sub> <sup>-</sup> 2000 ppm | 3200053532 |
|                   | Y044, NO <sub>3</sub> <sup>-</sup> 30 ppm   | 3200053535 |
|                   | Y042, NO <sub>3</sub> <sup>-</sup> 300 ppm  | 3200053514 |
|                   | Y041, NO <sub>3</sub> <sup>-</sup> 5000 ppm | 3200053433 |
| Sampling sheet B  | Y046, 100 sheet-pack                        | 3200053858 |

## Part Names

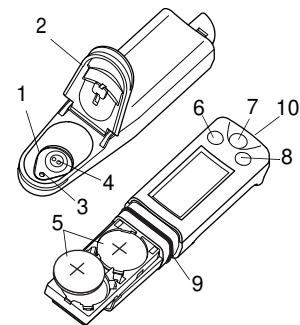

- 1 Flat sensor
- 2 Light shield cover
- 3 Liquid junction
- 4 Response membrane
- 5 Lithium batteries
- 6 MEAS switch
- 7 ON/OFF switch
- 8 CAL switch
- 9 Waterproof gasket
- 10 Strap eyelet

### Note

Press the switches 0.5 seconds or more unless otherwise specified.

## Initial Setup

### Attaching/detaching the sensor

#### Attaching the sensor

1. Power OFF the meter.
2. Confirm that the waterproof gasket is clean and undamaged.
3. Slide the sensor onto the meter so that catch "A" on the back of the meter fits into hole "a" on the sensor tongue as shown.

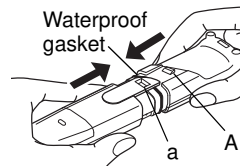

### Note

Be careful not to twist the waterproof gasket.

### ● Detaching the sensor

1. Power OFF the meter.
2. Lift the sensor tongue tip and slide the sensor a little away from the meter.
3. Pull out the sensor all the way from the meter.

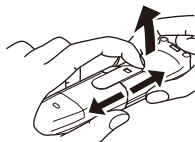

### ■ Inserting/removing batteries

#### ● Inserting the batteries

1. Power OFF the meter.
2. Slide both batteries into the battery case as shown.

Be sure to use two CR2032 batteries, and put them with the plus sides (+) upwards.

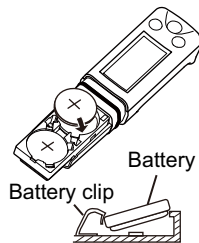

#### ● Removing the batteries

1. Power OFF the meter.
2. Use a ball-point pen or other tool to pry the batteries out from the clips as shown.

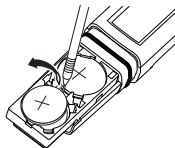

### ■ Electrode conditioning

#### Note

- Before using the sensor for the first time or after several days of disuse, perform electrode conditioning.
- Perform calibration after electrode conditioning.

1. Place some drops of 2000 ppm standard solution to the flat sensor.
2. Wait a few hours before use.  
There is no need to switch the meter ON.
3. Clean the flat sensor with running water.

## Basic Operation

### ■ Power ON

1. Press and hold the ON/OFF switch.

The power is switched ON, and the meter model number is displayed on the LCD.

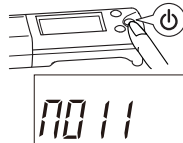

### ■ Power OFF

1. Press and hold the ON/OFF switch.

The power is switched OFF.

## Calibration

Calibration is required before measurement. Use standard solution within the measurement range in the specifications. See also the tip of "How to select standard solution" below.

#### Tip

- Calibration values are saved even if the meter is switched OFF.
- Calibration value is rewritten if calibration is repeated using the same standard solution.

### ■ Calibration points

The number of calibration points is up to 2.

### ■ Multi-point calibration

1. Set the concentrations of standard solution for calibration referring to "● 1st calibration point setting" (page 5) and "● 2nd calibration point setting" (page 5).

The 1st point is set to 150 ppm and the 2nd point is set to 2000 ppm by the default.

2. Open the light shield cover and place some drops of the standard solution on the flat sensor taking care to cover the entire flat sensor.

Rinsing the sensor with the standard solution beforehand will provide a more accurate calibration as it will reduce sample crossover contamination.

3. Close the light shield cover and press the CAL switch.

The meter enters the CAL mode and blinks the display of the set 1st-point concentration. Pressing the MEAS switch switches the displayed value between the set concentrations.

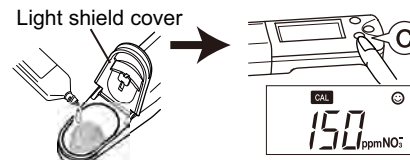

4. With the set concentration of the 1st point displayed, press the CAL switch.

**CAL** and ☺ blink, and the calibration value is displayed.

After the calibration is complete, **CAL** and ☺ stop blinking and the measured value is displayed.

The calibration value at 25°C is displayed for 1 s and the display returns to the measurement mode automatically.

5. Open the light shield cover and remove the standard solution. Then remove moisture on the sensor by gently dabbing with a soft tissue.

This completes the 1st point calibration.

6. To perform 2nd point calibration, repeat steps 2. to 5.

### ● Calibration error

If **CAL** blinks and Er4 (error display) appears, the calibration has failed.

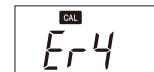

Perform electrode conditioning. Check that the correct standard solution is used, and repeat calibration after cleaning the sensor. If the calibration repeatedly fails when using the correct standard solution(s), the sensor may have deteriorated. Replace the sensor with new one.

#### Tip

How to select standard solution:

The following table show an example of the relationship between the concentrations of targeted samples and standard solution used for calibration.

| Targeted sample concentration | Standard solution [unit: ppm] |      |
|-------------------------------|-------------------------------|------|
|                               | Low                           | High |
| 2000                          | 2000                          | 9000 |
| 150                           | 150                           | 2000 |
| 15                            | 15*                           | 150  |

\*How to prepare 15 ppm standard solution: Mix one part 150 ppm standard solution to 9 parts purified water (1:9 volume ratio).

For accurate measurement, calibrate using 2 points of standard solution with a tenfold or more concentration difference encompassing the target concentration.

When the concentration to be measured is very high or very low, accuracy may be poorer.

## Measurement

### ■ Sample setting

1. Open the light shield cover and put some drops of sample on the flat sensor to cover the entire flat sensor.
2. Close the light shield cover.

### ■ Measurement mode

The auto stable (AS) mode and the auto hold (AH) mode can be selected. Refer to "● Measurement mode change" (page 5) for the operation to set the measurement mode.

### ● Auto stable (AS) mode

This is the default setting. ☺ appears when the measured value meets the stability criteria. If the value changes, ☺ disappears.

1. Confirm that the meter is in the measurement mode, and place a sample on the sensor.

When the read value meets the stability criteria, ☺ appears and the reading is locked.



2. Document the displayed value when ☺ appears.

If the read value does not meet the stability criteria, ☺ disappears and the reading changes with time.

### ● Auto hold (AH) mode

☺ appears when the measured value meets the stability criteria. The reading then locks and will not change until the MEAS switch is pressed for the next measurement.

1. Confirm that the meter is in the measurement mode, and place a sample on the sensor.

2. Press the MEAS switch.

The auto hold function is activated.

MEAS blinks until the measured value has stabilized.



When the measured value is stable, MEAS stops blinking and the displayed value is locked with MEAS and ☺ displayed simultaneously.

3. Document the displayed value.

4. Press the MEAS switch.

The auto hold function is deactivated and ☺ disappears.

Be sure to perform this step before starting the next measurement. Or, you may mistake the displayed hold value for the next measured value.

### Note

- If a measured value is out of the specified measurement range, "Or" is displayed for upper range and "Ur" is displayed for under range.
- When you have a problem with the calibration or measurement, refer to frequently asked questions.

### ■ Sampling sheet

#### ● For a minute sample

Try to use the provided sampling sheet B for a minute sample.

Using this sheet, the entire flat sensor can be covered with only 50  $\mu$ L to 100  $\mu$ L sample.

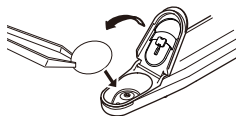

### Note

- Note that reaction between sample and sampling sheet B may affect the measured value.
- Handle sampling sheet B with tweezers to minimize possible contamination.
- Be sure to close the light shield cover during measurement to minimize possible sample evaporation.

#### ● For a sample containing tiny particles

If tiny particles are contained in a sample, such as an extract from soil, the particles influence measurement results. Use the sampling sheet holder cover and sampling sheet B sold separately to counteract the influence.

### Note

The sampling sheet holder cover does not shield the sensor from light, which affects the sensor. When using the sampling sheet holder cover, shield the flat sensor from light with an alternative.

1. Replace the light shield cover with the sampling sheet holder cover.
2. Put a piece of sampling sheet B on the flat sensor and close the sampling sheet holder cover.
3. Put 4 or 5 drops of sample on the sampling sheet B.

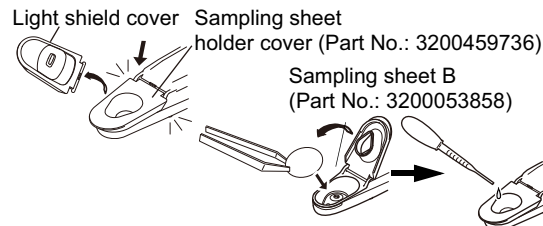

### ■ Measurement display change

The display mode switches among concentration (the unit depends the setting), temperature, and voltage by pressing the MEAS switch in the AS mode.

### Maintenance

#### ■ Storage

1. Clean the sensor with tap water.
2. Dab gently with soft tissue or cloth to remove moisture on the sensor and meter.

### Note

Especially be sure to treat the flat sensor gently to prevent damaging it.

3. Close the light shield cover and the slide cap before storing the meter.

#### ■ Temperature sensor adjustment

To perform accurate measurement with correction for temperature effects, follow the steps below. Normally this is not necessary.

1. Ready a reference thermometer, and allow the meter and reference thermometer to reach to room temperature.

2. Set the display mode to temperature referring to "■ Measurement display change" (page 3).

3. Press the CAL switch.

The meter displays the setting screen for target temperature.

4. Press the MEAS switch to adjust the displayed temperature on the meter to match the temperature indicated by the reference thermometer.

Pressing the MEAS switch increases the displayed temperature. After the displayed temperature reaches 40°C, it returns to 5°C.

5. Press the CAL switch again to apply the displayed value to the adjustment.

The adjustment starts. The adjusted value blinks with CAL and °C displayed.

After the adjustment is complete, the adjusted value stops blinking with MEAS and °C displayed.

If Er4 (error display) appears, the adjustment has failed. Retry the above steps increasing the time spent on the step 1.

If the adjustment repeatedly fails, the sensor may have deteriorated. Replace the sensor with new one.

### ■ Initializing calibration data

Initialize calibration in the following cases.

- To delete the calibration data
- If the number of points for the last calibration is uncertain.
- After the sensor is replaced.

1. Press and hold the CAL and ON/OFF switches for over 3 seconds when the meter is switched OFF to initialize calibration.

After a moment of all segment indication, the software version is displayed.

And then, the display changes as shown right.

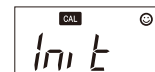

## 2. Press the CAL switch.

All calibration data is reset. When the initialization of calibration data is complete, End appears.

End

The meter automatically switches OFF.

## ■ Initializing the settings

All setup choices are erased. The meter is reset to the factory default values.

### 1. Press and hold the MEAS, CAL and ON/OFF switches for over 3 seconds when the meter is switched OFF to enter the initialization.

After a moment of all segment indication, the software version is displayed. And then, the display changes as shown right.

Int

### 2. Press the CAL switch.

All calibration data is reset. When the initialization of settings is complete, End appears.

End

The meter automatically switches OFF.

ion coexisting in a sample, the target measurement shows approximately  $1 \times 10^{-2}$  (1%) higher result.

## ■ Frequently asked questions

| Question  | Answer  |
|---|---|
| How can I check the sensor's condition?                       | Perform 2-point calibration. If calibration error occurs, the sensor has deteriorated. Replace the sensor.  |
| Can I measure high or low temperature samples?                | This meter cannot measure a sample with temperatures outside the meter's operating temperature range (5°C to 40°C).<br>The difference between the sample temperature and ambient temperature increases the measurement error. Perform measurement after the sample reaches the ambient temperature. |
| The measured value does not change after changing the sample. | If ☺ lights steadily in AH mode, the measured value is locked. Press the MEAS switch to unlock the value.<br>If the value does not change after unlocking, the sensor may be damaged. Replace the sensor.   |
| "Or" or "Ur" blinks in value measurement.                     | The measured value may be out of the specified measurement range. Measure a standard solution to check, and if "Or" or "Ur" still blinks, replace the sensor.   |
| °C blinks during measurement.                                 | The measured temperature is not within the specified operating temperature (5°C to 40°C).<br>If the ambient temperature is within the specified range and °C blinks, replace the sensor.  |
| The meter does not power ON.                                  | Check that the batteries are inserted properly. If the battery voltage is low, replace them both with new ones at the same time.  |

| Question                                | Answer   |
|---|--|
| Er4 is displayed during the calibration | Please note that if you press the CAL switch in mV or temperature display mode, Er4 is displayed. This is because there is no calibration facility available for these modes.  |
| Er1 is displayed soon power ON.         | The internal IC in the meter may be defective. Perform meter initialization.<br>If Er1 is still displayed after the initialization, the internal IC in the meter is defective. Replace the meter with a new one (the meter cannot be repaired).  |
| Er2 is displayed right after power ON.  | The internal IC in the meter is defective. Replace the meter with a new one (the meter cannot be repaired).  |
| Er3 is displayed right after power ON.  | The internal IC in the meter is defective. Replace the meter with a new one (the meter cannot be repaired).  |
| What factors interfere measurement?     | Strong acids or strong alkalis influence measurement results. Measure within the range from 2 pH to 9 pH.<br>Chloride ions (Cl <sup>-</sup> ), oils, and fats influence measurement results. Therefore, a sample of seashore soil or fatty crops may cause measurement errors.<br>Also, a sample of significantly high conductivity may cause measurement errors.<br>Refer to "■ Interfering ions" (page 4) for details. |

| Question   | Answer   |
|--|--|
| Are there any helpful tips or precautions to be aware for measurement? | When the sample amount is enough, washing the sensor twice or so with the sample allows more accurate measurement.<br><br>Residue between the light shield cover and flat sensor prevents accurate measurement. Before measurement of the next sample, wash the sensor with tap water and remove moisture.   |
| Can I prepare standard solutions myself?                               | Only for LAQUAtwin-NO3-11, you can prepare standard solutions by dissolving potassium nitrate in ionexchanged water to the specified concentration.<br>For LAQUAtwin-NO3-11C and LAQUAtwin-NO3-11S, use the dedicated standard solutions (30 ppm, 300 ppm, and 5000 ppm) that are made from materials other than potassium nitrate to adjust the conductivity. |

## Appendix

### ■ Interfering ions

|  |  |
|--|--|
| Target   | Nitrate ion (NO <sub>3</sub> <sup>-</sup> )  |
| Interfering ions and selectivity coefficients                          | I <sup>-</sup> : 10<br>NO <sub>2</sub> <sup>-</sup> : $7 \times 10^{-1}$<br>Cl <sup>-</sup> : $4 \times 10^{-2}$<br>Br <sup>-</sup> : $9 \times 10^{-1}$<br>(at $10^{-3}$ mol/L NO <sub>3</sub> <sup>-</sup> ) |
| pH range   | 3 pH to 8 pH<br>(at $10^{-3}$ mol/L NO <sub>3</sub> <sup>-</sup> )   |
| * Samples containing ClO <sub>4</sub> <sup>-</sup> cannot be measured. |  |

Selectivity coefficient is a concentration ratio of the interfering ion against the target ion, which affects the target ion measurement value. For example, selectivity coefficient of interfering ion against target ion is  $1 \times 10^{-2}$ , which means for the same concentration of interfering ion and target

# Setup Mode

The setup mode allows the user to customize the meter to his specific needs. To enter the setup mode, press and hold the MEAS and ON/OFF switches for over 3 seconds when the meter is switched OFF. All the LCD segments appear and then the meter enters the setup mode.

- Tip**
- To have the changes apply, you need to go through the entire steps from "Setup mode entry" to "Setup completion" shown below. To leave a setting as it is, just press CAL switch in the setting.
  - To exit the setup mode with no change of settings, press the ON/OFF switch earlier than pressing CAL switch in the last step but one, or the "Backlight setting" step.

## Setup mode entry

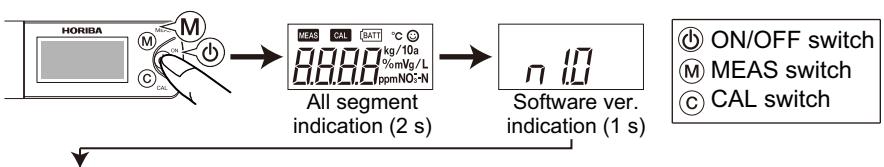

## Unit setting

The display units can be changed.

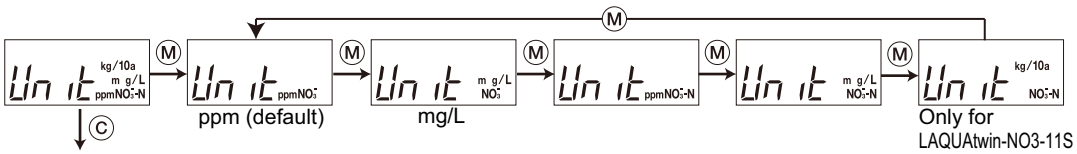

## 1st calibration point setting

The concentration of the 1st calibration point can be set.

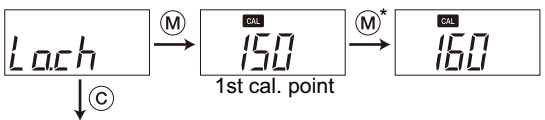

## 2nd calibration point setting

The concentration of the 2nd calibration point can be set.

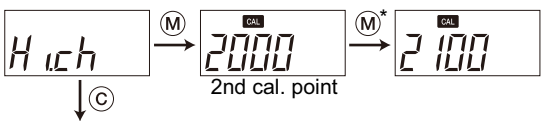

**Note**  
If you changed either of the calibration concentration settings, calibrate again at the both set concentrations before measurement. When either calibration concentration is changed, the calibration data are initialized.

\* In calibration point setting, pressing the MEAS switch increases the displayed value. After the displayed value reaches 9800, it returns to 7.

## Measurement mode change

The measurement mode can be switched.

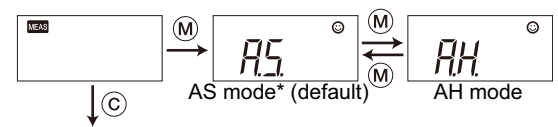

\* Measurement display change is available in the AS mode. Refer to "Measurement display change" (page 3).

## Multiplying compensation setting

The coefficient (0.01 to 9.90) to be applied to the measured value can be set. The compensated result is displayed as the measured value. The default setting is 1.00.

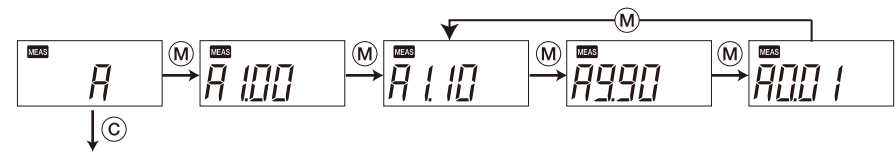

## Backlight setting

The backlight can be switched to ON or OFF.

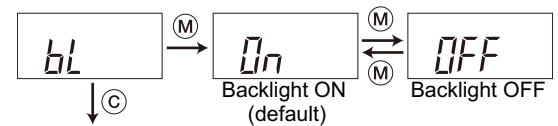

## Setup completion

