

Catalogue No: AU25712

60 Litre Flammable Storage Cabinet



Justrite cabinets: are the only cabinet that have been fire tested and rated by FM Global (Factory Mutual performance standard that is recognised by Insurance Companies) “Something no other cabinet in Australia can claim”

During the 10 minutes test period the internal temperature shall not exceed 163 Celsius.



Catalogue No: AU25712
Flammable Storage Cabinet
Complies with AS1940—2017
60 Litre Maximum Capacity

External Size: 1005mm H x 595mm W x 465mm D
Internal Size: 765 mm H x 505mm W x 375mm D

Supplied with two shelves as standard.
Extra Shelves may be added:
Product Code: AU25995

FM Global Approved & Fire Rated
(Factory Mutual Insurance Endorsement)

All Justrite Storage Cabinets are manufactured to comply fully with the relevant Australian Standards.

Powder Coat paint finish provides A superior no - drip, high gloss finish which minimises the effects of corrosion and humidity. The durable finish can withstand the abrasive type abuse as other types of finishes.

Locking Mechanism, the three point locking with fail safe closing mechanism. The locking bars are specially developed to avoid bending and distortion providing a distinct locking effect. The locking mechanism also has an option to padlock the cabinet as well.

All cabinets are fitted with self closing door. This provides a seal around the doors.

Full length door piano hinge provides a durable sealed barrier to cabinets contents.
Adjustable levelling feet at all four corners.

Shelving design permits the ventilation throughout the cabinet and troughs in each shelf collects spills and directs these away from contaminating products stored on the lower shelves. Shelves are adjustable incremental 76mm.

Each cabinet is provided standard with a 150mm deep fully sealed sump to contain spills or leaks within the cabinet. An additional shelf is included in our pricing to fit above the sump and utilise this as additional storage area.

Self closing mechanism is housed in the roof of the cabinet. This provides additional area within the cabinet for storage and avoids damage and alignment disorder. Cabinet closure mechanism are easily adjusted by removal of the four self tapping screws.

Dual 50mm NPS vents are provided with built in flash arresters. Where applicable hazardous vapours may be piped away.

Thermal Fusible Door Links for holding doors open while loading and unloading. This link separates at a temperature of 72 degrees to allow doors to close.

Double wall thermal barrier. 1.2mm steel thickness with 40mm air wall spacing.

After sales service and training available. It is our pleasure to provide a presentation after installation of the Justrite cabinets on the proper use and functions of each cabinet.

Delivery, most cabinets are available ex stock to meet your requirements.

10 Year Manufacturing Warranty



JUSTRITE CABINETS EXCEED THE AUSTRALIAN STANDARD COMPLIANCE AS1940

Justrite cabinets: are the only cabinet that have been fire tested and rated by FM Global (Factory Mutual performance standard that is recognised by Insurance Companies)

"Something no other cabinet in Australia can claim"

During the 10 minutes test period the internal temperature shall not exceed 163 Celsius

"Ask for the mark of quality"



Haz-Alert Reflective labelling provides high visibility in the dark under fire conditions or power outage when illuminated by flashlight beam. Patent Pending.



Patented concealed self-close mechanism provides obstruction free access to top shelf space. Self-indexing doors guarantee they will close in sequence and assure a tight closure from top to bottom.



Rounded safety corners on doors reduce accidental nicks or cuts and potential hand injury.



(sample) FM Certification Decal

Minimal air-gaps provide better protection.

Double Wall thermal barrier 1.2mm sheet steel thickness with 40mm wall spacing.

Easy Close, Self latching doors.

Fully welded (not riveted) construction holds squareness for longer life, offering greater protection in a fire since air gaps are reduced.

Continuous piano hinges provides smooth closure.

Durable and chemical-resistant, lead-free powder-coat paint finish, inside and out, retains high gloss look and minimizes the effects of corrosion.

Exclusive U-Lock Padlockable Handle. Optional padlock allows for extra security and key-coding multiples for convenient access. Flush paddle handle with slip resistant grip offers easy fingertip operation and reduces dangerous "catches" from passing traffic. Double key set included for keyed lock. Patent Pending. Padlock not included.

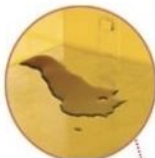

Exclusive SpillSlope safety shelves directs spills to back and bottom of leak proof sump. Heavy gauge galvanised steel shelves are bi-directional and easily adjust on 76mm centres for versatile storage. Each cabinet is provided standard with 150mm deep sump to contain spills or leaks within the cabinet.

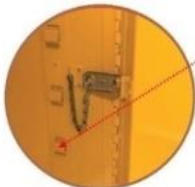

Welded shelf hangers interlock with shelf to offer maximum "no slip" stability.. And no flimsy brackets to lose.

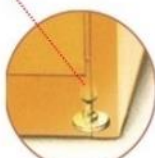

Adjustable leveling feet for stability on uneven surfaces.



Dual vents with built in flame arresters strategically placed at top and opposite bottom are welded not screwed in place.

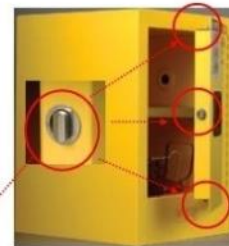

Stainless Steel, three point bullet self-latching system provides easy, fail-safe, positive door closure with increased heat resistance.

Fusible links hold doors wide open and melt at (74 C) for Automatic closure.

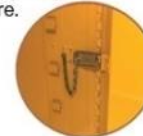

Built in grounding connector (on outside side panel) for easy grounding.



CABINET DIMENSIONS

Model Number	Capacity	Shelves	Doors	External Measurement H x W x D	Internal Measurement
AU25602	350	3	2	1760 x 870 x 870	1520 x 785 x 785
AU25452	250	3	2	1760 x 1100 x 465	1520 x 1020 x 375
AU25302	160	2	2	1230 x 1100 x 465	990 x 1020 x 375
AU25304	110	2	1	1230 x 670 x 465	990 x 590 x 375
AU25308	170	3	1	1760 x 670 x 465	1520 x 590 x 375
AU25744	70	1	2	735 x 770 x 565	505 x 710 x 485
AU25748	100	2	2	800 x 920 x 565	560 x 830 x 480
AU25712	60	2	1	1005 x 595 x 465	765 x 505 x 375
AU25714	30	2	1	800 x 595 x 465	560 x 505 x 375
AU25716	15	1	1	565 x 432 x 432	470 x 349 x 349
AU25701	250		2	1760 x 870 x 870	1520 x 785 x 785
AU25662	250		2	1385 x 765 x 1225	1145 x 685 x 1145
AU29801CS	45	1	2	425 x 1092 x 457	310 x 1003 x 370
AU29804SC	64	1	2	610 x 1092 x 457	485 x 1003 x 370

All models of cabinets have the same external and internal measurements for Flammable, Corrosive, Poisons, Pesticides, Oxidising Agents and Organic Peroxides cabinets. For more information on storing within the Oxidising Agent, Organic Peroxides and Pesticides cabinets please contact our customer service

Catalogue No: AU25712

60 Litre Flammable Storage Cabinet

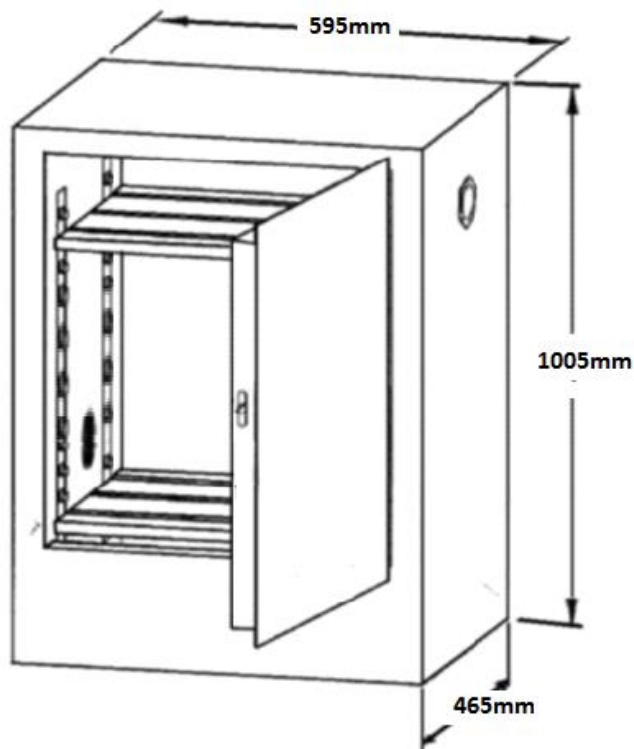

Left Side Vent Position

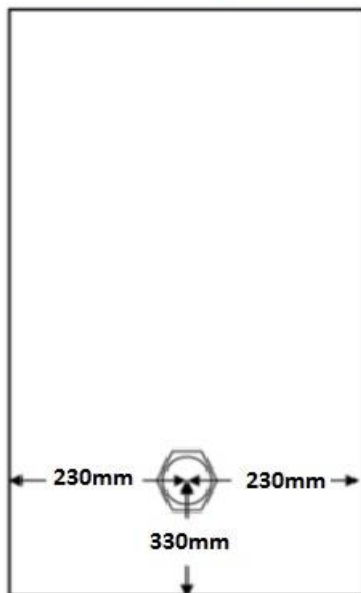

Right Side Vent Position

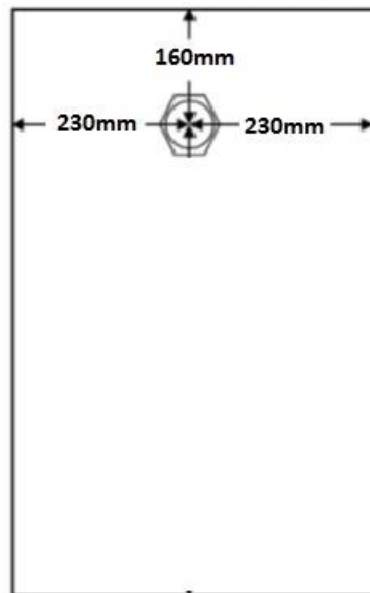

Base of Cabinet Ground Level